



# XL6/XL6M/XL6e OCS Models

## HE-XL100 / HE-XL1M0 / HEXT350C100 / HEXT280C100 HE-XL1E0 / HEXT351C100

**1 Specifications**

Specifications	
Required Power (Steady state)	500 mA @ 24 VDC
Required Power (Inrush)	30 A for 1 ms @ 24 VDC – DC Switched 2.5 A for 4 ms @ 24 VDC - AC Switched
Primary Power Range	10 – 30 VDC
Relative Humidity	5 to 95% Non-condensing
Clock Accuracy	+/- 35 ppm maximum at 25° C (+/- 1.53 Minutes per Month)
Operating Temp	-10°C to +60°C
Display Type	5.7" QVGA TFT
Display Size	5.7"
Display Screen Dimension	320 x 240
Display Memory	2.75 MB
Display Life	Minimum 40000 hours (50% brightness, 25 deg C)
User Keys	5 user-defined Function keys and a System Key
Screens supported	1023
Colors	32768/ 16 shade Grey scale (XL6M models only)
Weight	26.5 oz. (.751 kg)
CE	USA: <a href="http://www.heapg.com/Pages/TechSupport/ProductCert.html">http://www.heapg.com/Pages/TechSupport/ProductCert.html</a>
UL	Europe: <a href="http://www.horner-apg.com/en/support/certification.aspx">http://www.horner-apg.com/en/support/certification.aspx</a>
Connectivity	
Serial Ports	2 Serial Ports – RS232 & RS485
Ethernet	10/100-Mbps (XL6e models only)
USB	USB Networking Port for communication with PCs, flash device connectivity and programming Port
Removable Media	Removable Media for upto 2 GB of storage for programs, data logging or screen capture
Smartstix	Remote IO modules communicating on CAN

**2 Installation**

1. Prior to mounting, observe requirements for the panel layout design and spacing/clearances in the OCS XL6 Series Manual (MAN0883).
2. Cut the host panel.
3. Insert the OCS through the panel cutout (from the front). The gasket material needs to be between the host panel and the OCS.

**Caution: Do not force the OCS into the panel cutout. An incorrectly sized panel cutout can damage the touch screen.**

4. Install and tighten the mounting clips (provided with the OCS) until the gasket material forms a tight seal.
5. Connect cables as needed such as communications, programming, power and CsCAN cables to the ports using the provided connectors.
6. Begin configuration procedures.

**3 Panel Cut-Out and Dimensions**

Note: Max. panel thickness: 5 mm.

Refer to the User Manual (MAN0883) for panel box information and a checklist of requirements.

**Note:** The tolerance to meet NEMA standards is ± 0.005" (0.1 mm).

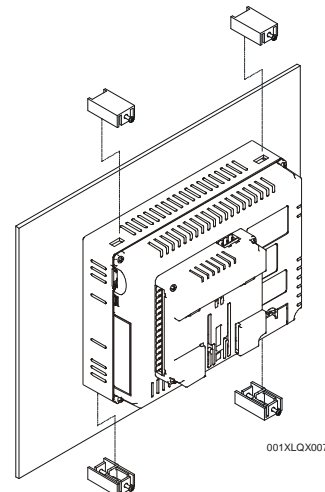
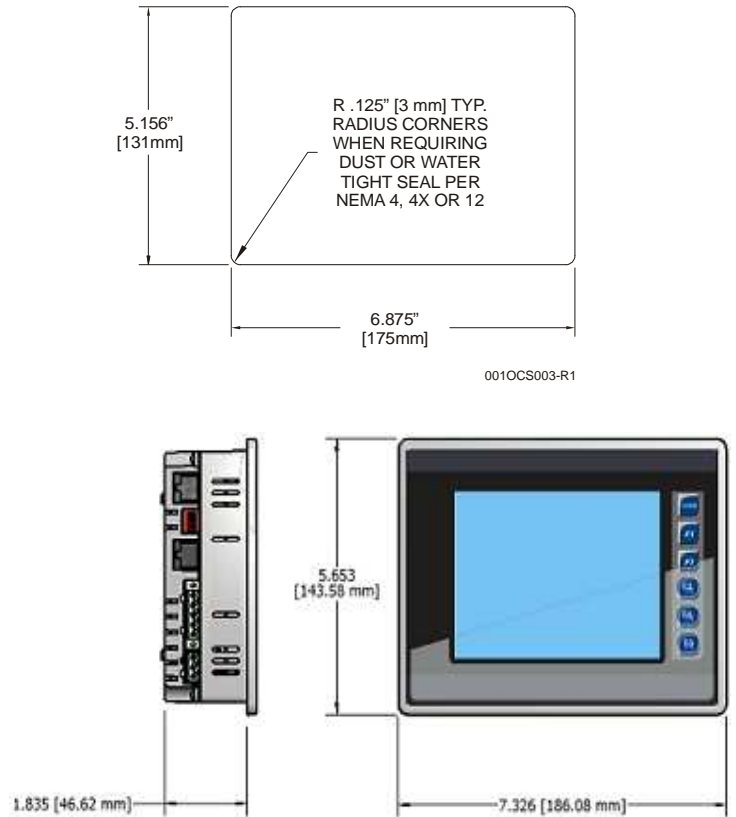

Mounting clips

4 Ports and Connectors

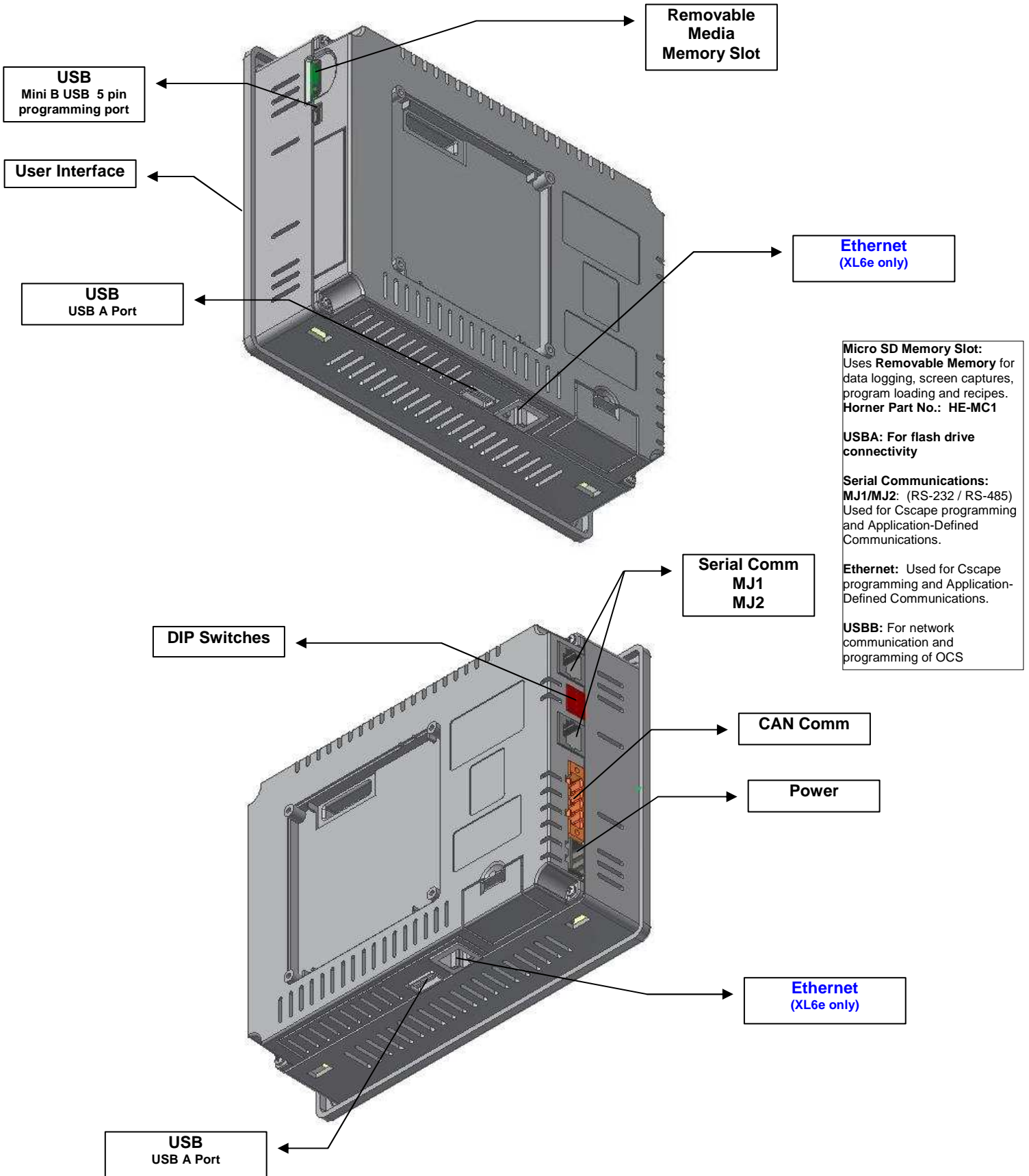

4.1 Serial Communications:

**MJ1:** (RS-232 / RS-485) Use for Cscape programming and Application-Defined Communications.

**MJ2:** (RS-232 / RS-485) Use for Application-Defined Communications.

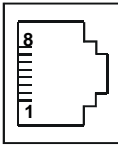

Pin	MJ1 Pins		MJ2 Pins	
	Signal	Direction	Signal	Direction
8	TXD	OUT	TXD	OUT
7	RXD	IN	RXD	IN
6	0 V	Ground	0 V	Ground
5*	+5 60mA	OUT	+5 60mA	OUT
4	RTS	OUT	TX-	OUT
3	CTS	IN	TX+	OUT
2	RX- / TX-	IN / OUT	RX-	IN
1	RX+ / TX+	IN / OUT	RX+	IN

MJ2 Pinouts in Half and Full Duplex Modes

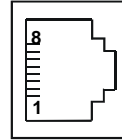

Pin	MJ2 Pins	
	Signal	Direction
8	TXD	OUT
7	RXD	IN
6	0 V	Ground
5*	+5 60mA	OUT
4	TX-	OUT
3	TX+	OUT
2	TX-/RX-	IN/OUT
1	TX+/RX+	IN/OUT

\* +5V 60mA Max

MJ2 Half Duplex Mode

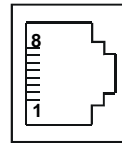

Pin	MJ2 Pins	
	Signal	Direction
8	TXD	OUT
7	RXD	IN
6	0 V	Ground
5*	+5 60mA	OUT
4	TX-	OUT
3	TX+	OUT
2	RX-	IN
1	RX+	IN

\* +5V 60mA Max

MJ2 Full Duplex Mode

Functions	Port 1 (MJ1)	Port 2 (MJ2)
RS-232	✓	✓
Hardware Handshaking	✓	X
Programming	✓	X
Ladder function controlled	✓	✓
Serial Downloadable Protocols	✓	✓
RS 485 Full duplex	X	✓
RS 485 Half duplex	✓	✓

4.2 External DIP Switch Settings

As seen when looking at the side of the XL6 unit:

The DIP Switches are used for termination of the RS-485 ports. The XL6 is shipped un-terminated.

To terminate, select one of the DIP Switches and configure it based upon the option that is desired.

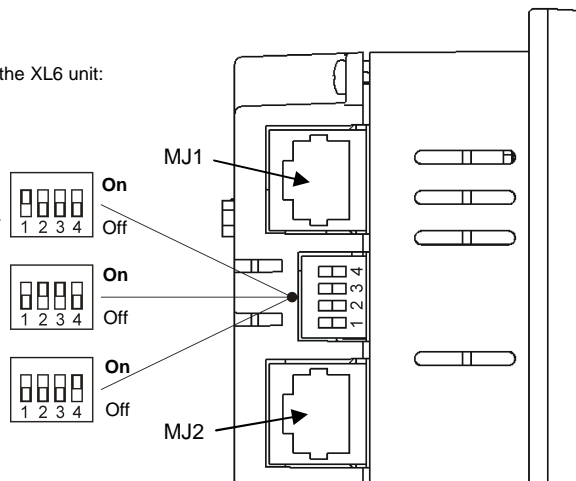

SW1 - ON enables **MJ2** RS485 port termination (121 Ohms). OFF disables **MJ2** RS485 port termination.

SW2 & SW3 - ON places **MJ2** RS485 port in half-duplex mode. OFF places **MJ2** RS485 port in full-duplex mode.

SW4 - ON enables **MJ1** RS485 port termination (121 Ohms). OFF disables **MJ1** RS485 port termination.

**4.3 CAN Network Port and Wiring**

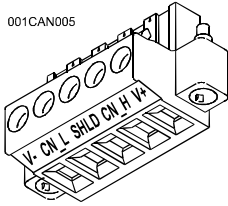

**CAN Connector**

Use the CAN Connector when using CsCAN network.

Torque rating 4.5 – 7 Lb-In (0.50 – 0.78 N-m)

NET1 Port Pin Assignments			
Pin	Signal	Signal Description	Direction
1	V-	CAN Ground	-
2	CN_L	CAN Data Low	In/Out
3	SHLD	Shield Ground	-
4	CN_H	CAN Data High	In/Out
5	NC	No Connect	-

**4.4 Ethernet Port**

Speeds	10 BaseT Ethernet (10-Mbps) 100 BaseTx Fast Ethernet (100-Mbps)
Modes	Half or Full Duplex
Auto-Negotiation	Both 10/100-Mbps and Half/Full Duplex
Connector Type	Shielded RJ-45
Cable Type (Recommended)	CAT5 (or better) UTP
Port	Auto MDI/MDI-X

**4.5 Power Port and Wiring**

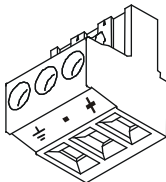

**Power Connector**

**Power Up:**

Connect to Earth Ground.  
Apply 10 - 30 VDC.  
Screen lights up.

Torque rating 4.5 – 7 Lb-In (0.50 – 0.78 N-m)

Primary Power Port Pins		
Pin	Signal	Description
1	Ground	Frame Ground
2	V-	Input Power Supply Ground
3	V+	Input Power Supply Voltage

**6 Technical Support**

For assistance and manual updates, contact Technical Support at the following locations:

**North America:**  
Tel: 317 916-4274  
Fax: 317 639-4279  
Web: <http://www.heapg.com>  
Email: [techsppt@heapg.com](mailto:techsppt@heapg.com)

**Europe:**  
Tel: +353-21-4321266  
Fax: +353-21-4321826  
Web: <http://www.horner-apg.com>  
Email: [tech.support@horner-apg.com](mailto:tech.support@horner-apg.com)

**5 Safety**

When found on the product, the following symbols specify:

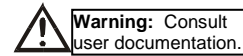
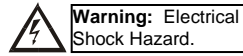

This equipment is suitable for use in Class I, Division 2, Groups A, B, C and D or Non-hazardous locations only.

**WARNING – EXPLOSION HAZARD** – Do not disconnect equipment unless power has been switched off or the area is known to be non-hazardous.  
**AVERTISSEMENT - RISQUE D'EXPLOSION** - AVANT DE DECONNECTER L'EQUIPMENT, COUPER LE COURANT OU S'ASSURER QUE L'EMPLACEMENT EST DESIGNE NON DANGEREUX.

**WARNING:** To avoid the risk of electric shock or burns, always connect the safety (or earth) ground before making any other connections.

**WARNING:** To reduce the risk of fire, electrical shock, or physical injury it is strongly recommended to fuse the voltage measurement inputs. Be sure to locate fuses as close to the source as possible.

**WARNING:** Replace fuse with the same type and rating to provide protection against risk of fire and shock hazards.

**WARNING:** In the event of repeated failure, do not replace the fuse again as a repeated failure indicates a defective condition that will not clear by replacing the fuse.

**WARNING – EXPLOSION HAZARD** – Substitution of components may impair suitability for Class I, Division 2

**AVERTISSEMENT - RISQUE D'EXPLOSION** - LA SUBSTITUTION DE COMPOSANTS PEUT RENDRE CE MATERIAL INACCEPTABLE POUR LES EMBLEMES DE CLASSE 1, DIVISION 2.

**WARNING** - The USB parts are for operational maintenance only. Do not leave permanently connected unless area is known to be non-hazardous.

**WARNING – EXPLOSION HAZARD** - BATTERIES MUST ONLY BE CHANGED IN AN AREA KNOWN TO BE NON-HAZARDOUS.

**AVERTISSEMENT - RISQUE D'EXPLOSION** - AFIN D'EVITER TOUT RISQUE D'EXPLOSION, S'ASSURER QUE L'EMPLACEMENT EST DESIGNE NON DANGEREUX AVANT DE CHANGER LA BATTERIE.

**WARNING** - Battery May Explode If Mistreated. Do Not Recharge, Disassemble or Dispose Of In Fire

**WARNING:** Only qualified electrical personnel familiar with the construction and operation of this equipment and the hazards involved should install, adjust, operate, or service this equipment. Read and understand this manual and other applicable manuals in their entirety before proceeding. Failure to observe this precaution could result in severe bodily injury or loss of life.

This device complies with part 15 of the FCC Rules. Operation is subject to the following two conditions:

1. This device may not cause harmful interference.
2. This device must accept any interference received, including interference that may cause undesired operation.

**Radiated Emission Compliance:** For compliance requirement, a ferrite (Horner P/N FBD006 supplied with the unit) needs to be placed on the AC/DC line with one loop.

- All applicable codes and standards need to be followed in the installation of this product.
- Adhere to the following safety precautions whenever any type of connection is made to the module:
  - Connect the safety (earth) ground on the power connector first before making any other connections.
  - When connecting to electric circuits or pulse-initiating equipment, open their related breakers.
  - Do not make connections to live power lines.
  - Make connections to the module first; then connect to the circuit to be monitored.
  - Route power wires in a safe manner in accordance with good practice and local codes.
  - Wear proper personal protective equipment including safety glasses and insulated gloves when making connections to power circuits.
  - Ensure hands, shoes, and floor are dry before making any connection to a power line.
  - Make sure the unit is turned OFF before making connection to terminals.
  - Make sure all circuits are de-energized before making connections.
  - Before each use, inspect all cables for breaks or cracks in the insulation. Replace immediately if defective.

No part of this publication may be reproduced without the prior agreement and written permission of Horner APG, Inc. Information in this document is subject to change without notice.