

Installation, operation and maintenance instructions for Flowrox™ LPP-T32-T80 peristaltic hose pumps

Installation, maintenance and operating instructions



These instructions must be read carefully and understood prior to the installation, use, and servicing of this product.

DISCLAIMER

ALL DRAWINGS, SPECIFICATIONS, DATA, SOFTWARE, FIRMWARE, MANUALS, INSTRUCTIONS, DOCUMENTATION OR OTHER WORKS OF AUTHORSHIP FURNISHED BY VALMET ARE COPYRIGHTED PROPERTY OF VALMET OR ITS SUPPLIERS, AND ARE TO BE USED BY CUSTOMER, PURCHASER, SUBCONTRACTOR, SUPPLIER OR OTHER AUTHORIZED PERSONS (“USERS”) ONLY FOR THE PURPOSE OF INSTALLING, OPERATING, MAINTAINING AND REPAIRING THE GOODS AND SERVICES SUPPLIED BY VALMET (“PRODUCTS”). SUCH WORKS AND DATA MAY NOT BE OTHERWISE USED OR REPRODUCED OR DISCLOSED. VALMET OR ITS SUPPLIERS RETAIN ALL RIGHT, TITLE AND INTEREST IN AND TO ITS AND THEIR INVENTIONS, DISCOVERIES, CONCEPTS, IDEAS OR OTHER INTELLECTUAL PROPERTY EMBODIED IN OR RELATED TO ITS PRODUCTS.

ANY AND ALL TRADE SECRETS, SPECIFICATIONS, DRAWINGS, DESIGNS, SOFTWARE, SAMPLES, OTHER TECHNICAL, FINANCIAL, PRODUCT, MARKETING, SALES, PRODUCTION, SUBCONTRACTING, PRICING AND OTHER CONFIDENTIAL AND/OR PROPRIETARY INFORMATION OF A PARTY PERTAINING TO THE PRODUCTS OR OTHERWISE TO THIS CONTRACT, OR TO A PARTY, ITS PRODUCTS, BUSINESSES, OPERATIONS, OR PLANS, SHALL NOT BE DISCLOSED TO ANY UNAUTHORIZED THIRD PARTY BY THE OTHER PARTY. THE RECEIVING PARTY SHALL ENSURE THAT ITS DIRECTORS, OFFICERS, EMPLOYEES AND AGENTS COMPLY WITH THE OBLIGATIONS HEREIN. UNLESS OTHERWISE AGREED TO IN WRITING BY THE PARTIES, THE PARTIES' CONFIDENTIALITY, NON-DISCLOSURE AND NON-USE OBLIGATIONS HEREIN SHALL REMAIN IN FORCE TO THE MAXIMUM TERM PERMITTED BY APPLICABLE LAW.

THIS MANUAL PROVIDES INSTRUCTIONS TO CARRY OUT CERTAIN ACTIVITIES AND IS DESIGNED AND MEANT TO GUIDE AND ASSIST PROFESSIONAL AND PROPERLY TRAINED EXPERTS IN PERFORMING THEIR FUNCTIONS. EVERYONE MUST BECOME FAMILIAR WITH ALL INSTRUCTIONS IN THIS MANUAL BEFORE ANY INSTALLATION, USE, MAINTENANCE, REPAIR OR ANY OTHER ACTIONS OF THE RESPECTIVE GOODS AND/OR SERVICES WHICH THIS MANUAL APPLIES TO. ALL INSTRUCTIONS MUST BE FOLLOWED CAREFULLY. HOWEVER, OBSERVANCE OF ANY PART OF THE INSTRUCTIONS PRESENTED IN THIS MANUAL MAY BE OMITTED IN EVENT WHEN IT IS REQUIRED OR ALLOWED BY LAW. VALMET HAS TAKEN EVERY CARE IN THE PREPARATION OF THE CONTENT OF THIS MANUAL, BUT DOES NOT MAKE ANY REPRESENTATIONS, WARRANTIES OR GUARANTEES OR, EXPRESS OR IMPLIED, AS TO THE ACCURACY OR COMPLETENESS OF THIS MANUAL.

ALL USERS MUST UNDERSTAND AND BE AWARE THAT UPDATES AND AMENDMENTS WILL BE MADE FROM TIME TO TIME TO THIS MANUAL. ALL USERS ARE OBLIGATED TO FIND OUT AND DETERMINE WHETHER THERE HAVE BEEN ANY APPLICABLE UPDATES OR AMENDMENTS TO THIS MANUAL. NEITHER VALMET NOR ANY OF ITS DIRECTORS, OFFICERS, EMPLOYEES, SUBCONTRACTORS, SUB-SUPPLIERS, REPRESENTATIVES OR AGENTS SHALL BE LIABLE IN CONTRACT, TORT OR IN ANY OTHER MANNER WHATSOEVER TO ANY PERSON FOR ANY LOSS, DAMAGE, INJURY, DEATH, LIABILITY, COST OR EXPENSE OF ANY NATURE, INCLUDING WITHOUT LIMITATION INDIRECT, INCIDENTAL, SPECIAL, CONSEQUENTIAL, PUNITIVE OR DIRECT DAMAGES AND/OR LOSSES ARISING OUT OF OR IN CONNECTION WITH THE CREATION, DELIVERY, POSSESSION AND/OR USE OF THIS MANUAL. HOWEVER, NOTHING IN THIS PARAGRAPH IS DEEMED TO EXCLUDE OR RESTRICT ANY LIABILITY WHICH CANNOT BY MANDATORY LAW BE EXCLUDED.

FLOWROX™ IS EITHER REGISTERED TRADEMARK OR TRADEMARK OF VALMET OR ITS SUBSIDIARIES OR AFFILIATES IN THE UNITED STATES AND/OR IN OTHER COUNTRIES. ALL OTHER TRADEMARKS, LOGOS, BRANDS AND MARKS DISPLAYED IN THIS MANUAL ARE PROPERTY OF THE RESPECTIVE OWNERS UNLESS STATED OTHERWISE.

Copyright © 2014-2023 Valmet Corporation. All rights reserved.

Table of Contents

1 EU DECLARATION OF CONFORMITY	4	APPENDIX A: Tightening torques for LPP-T pumps	33
1.1 Mechanical warranty for LPP-T pumps	5	APPENDIX B: Required lubricant and compression torque values for LPP-T hoses	34
1.2 Safety instructions for LPP-T pumps	5	APPENDIX C: Hose leak detector chart	38
2 INTRODUCTION	6	APPENDIX D: Claim form	39
2.1 Applications and purposes of use	6	APPENDIX E: Dimensions, LPP-T pumps	40
2.2 General description	7	APPENDIX F: General safety warnings	41
2.3 Electrical equipment	11		
2.4 Technical data	12		
3 TRANSPORTATION, STORAGE AND LIFTING	13		
4 INSTALLATION	13		
4.1 General	13		
4.2 Pump installation	14		
4.3 Electrical connection	15		
4.4 Piping connections	15		
5 PUMP OPERATION	16		
5.1 Commissioning	16		
5.2 Operation	17		
6 SERVICING AND MAINTENANCE	18		
6.1 General maintenance and checks	18		
6.2 Changing the hose	19		
6.3 Adjusting the hose compression	27		
6.4 Maintenance	29		
6.5 Troubleshooting	32		

READ THESE INSTRUCTIONS FIRST!

These instructions provide information about safe handling and operation of the product

If you require additional assistance, please contact the manufacturer or manufacturer's representative.

SAVE THESE INSTRUCTIONS!

Addresses and phone numbers are printed on the back cover.

1 EU DECLARATION OF CONFORMITY

This declaration of conformity is issued under the sole responsibility of the manufacturer:

VALMET FLOW CONTROL OY

Marssitie 1

53600 Lappeenranta

Finland

Tel. +358 (0)10 417 5000

Product model/type: **Peristaltic Hose Pump LPP-D and LPP-T**

The object of the declaration described above is in conformity with the relevant Union harmonisation legislation:

Machinery Directive 2006/42/EC: Annex II A

ATEX Directive 2014/34/EU: Non-electrical equipment

Follow the pump installation, operating and maintenance instructions in this manual.

On behalf of Valmet Flow Control Oy

In Lappeenranta, 13th May 2022



Riku Salojärvi

Head of Operations

1.1 Mechanical warranty for LPP-T pumps

The warranty is valid for 12 months from the delivery date, excluding the following:

- wear parts, such as gaskets, bearings, and hoses (for requirements concerning hose manufacturing defects, see ‘PUMP HOSES’)
- pumps that the first buyer has resold without a written agreement with the vendor regarding the remaining portion of the warranty period
- direct or consequential damage caused by structural changes made to the pump or by the use of parts that are not approved by the original manufacturer

The purchaser must fill a claim for all compensation related to the hose and/or pump guarantee within 30 days after the fault has been detected. For the claim form, refer to Appendix.

If the terms indicated in the claim form are not complied with, the purchaser loses his or her right to the guarantee.

The guarantee compensates for new parts if any damaged parts must be replaced. Terms of delivery: packed at the factory, with no other costs covered.

PUMP HOSES:

The hose of the pump is in contact with the pumped product and is exposed to wear, high temperatures, pressure shocks, chemicals and other wearing mechanisms. The pump hose is therefore considered a wearing part that requires periodic replacement.

Flowrox pumps have proved reliable in several demanding applications. However, the operation conditions vary to the extent that we cannot specify an exact service life or guarantee period for the hose. The guarantee applies to only manufacturing defects of the hose.

If there is a manufacturing defect, the customer is entitled to return the defective hoses to the supplier. The supplier shall reimburse the customer for the value of the hoses, excluding the freight charges, packaging costs, and other expenses, upon the following conditions:







- the pump has been used only for its intended purpose
- for all claims regarding a hose fault, the hose in question, along with a description of the operational conditions and method used, has been delivered to Valmet Flow Control Oy for chemical and mechanical analysis







Possible reimbursement for a faulty hose shall be made only after the hose examination.

1.2 Safety instructions for LPP-T pumps

In this manual, the following symbols are used to highlight the parts requiring particular attention:

Hazard severity panels.

	 DANGER!
	DANGER indicates a hazard with a high level of risk which, if not avoided, will result in death or serious injury.
	 WARNING!
	WARNING indicates a hazard with a medium level of risk which, if not avoided, could result in death or serious injury.
	 CAUTION!
	CAUTION indicates a hazard with a low level of risk which, if not avoided, could result in minor or moderate injury.

SYMBOL	DESCRIPTION
	Risk to personal safety: Neglecting the safety measures can cause serious personal injury or death.
	Electrocution hazard: Neglecting the safety measures can cause serious personal injury or death.
	Falling load hazard
	Crushing hazard
	Read the operation and maintenance instructions: Read and understand the operation and maintenance instructions before using the product.
	Mandatory action symbol: Obey these instructions to prevent machine malfunctions.

Prevent accidents and ensure the pump's appropriate operation by complying with the safety instructions indicated in this manual. Installation and maintenance of the pump must be carried out by persons with appropriate training.

The safety aspects have been considered as much as possible in the design of the pump.

Never use the pump with the front cover or inspection glass open. If the glass must be removed for certain maintenance procedures, apply extreme caution. Keep all body parts away from the danger zone.

The pump has been connected to high voltage. The connection box must not be opened when the drive unit is connected. Electrical work must be carried out by professional electricians.

The pump can produce and maintain high pressure. This must be noted when someone opens the pipe connections etc. The pipeline can contain high pressure even after the pump has stopped. Unauthorised personnel are not allowed near the pump when it is in operation. The maintenance and servicing of the pump must be carried out by persons with appropriate training.

Pumps must always be equipped with the safety equipment required by national regulations as appropriate to the place of use. Regardless of national regulations, the pump unit power supply must be equipped with at least the following electrical safety devices:

- emergency switch
- main switch
- motor overload protector
- fuses

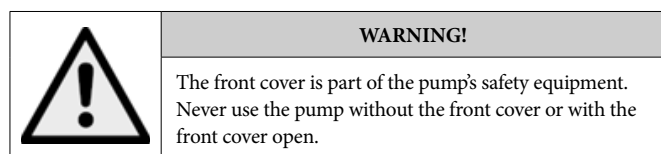

The following optional equipment is also considered safety equipment:

- hose leak detector: stops the pump if the hose breaks
- pressure transmitter with display and overpressure limit: stops the pump if the overpressure limit is exceeded

2 INTRODUCTION

2.1 Applications and purposes of use

LPP-T pumps are intended for pumping liquids, liquids containing solid matter, sludge, and aggressive liquids. Normal pumping operations include transfer, dosing, feeding, and drainage pumping. Use for other purposes is forbidden.

The LPP-T peristaltic hose pump is restarting and gasketless. The gasketless pump is not damaged even if it runs dry for a relatively long time. The only part of the pump that is in contact with the pumped medium is the hose. The hose is also the only part of the pump that requires regular replacement.

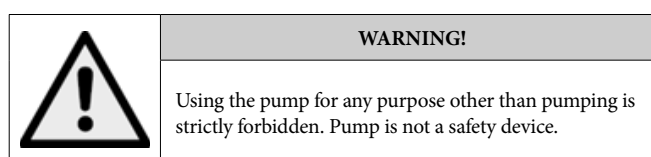

The protection class (IP) of the pump depends on the level of equipment installed. The normal protection class for the motor is IP54.

Restrictions on use for LPP-T pumps

The following restrictions on use must be taken into consideration:

- LPP-T pumps operate on the displacement principle, producing a fixed displacement flow for the pumping cycle. In some applications this might cause overpressure situations that may lead to equipment damage.
- The operation of the pump is peristaltic. The displacement flow produced by the pump is not continuous – there is a phase in each work cycle during which the displacement flow is zero.
- Thus the displacement flow produced by the pump is pulsatory, which is manifested in the piping as pressure pulsation. The pulsation can be dampened by using flexible piping parts or pulsation absorbers. Pulsation may be harmful for piping or other equipment connected to the piping.

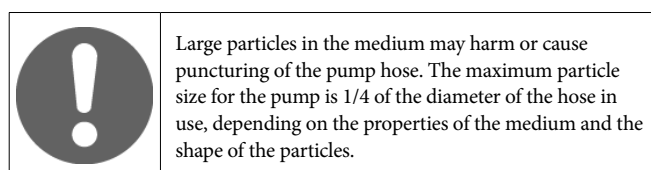

- Certain chemicals (especially chemicals at high temperature) cannot be pumped, or they may significantly shorten the operating life of the hose

Using the pump in explosive conditions

Special safety precautions must be followed when the pumps are used in explosive conditions. The compatibility of the pump for use in conditions classified as Ex as defined by the ATEX standard is indicated on the pump's type plate.

Special attention must be paid to the following precautions:

- preventive maintenance measures (changing the hose and lubricating the bearings)
- electrical earthing
- temperature of the pumped medium (heat is conducted into the pump structures)

Other matters to be taken into consideration:

- The LPP-T pump lubricant may react with oxidising substances, resulting in a risk of fire or explosion.
- The condition of the pump bearings and the sufficiency of the lubricant must be checked at least every three months (more often if the conditions so require).
- The pump frame must be earthed in case of static electric discharge.
- The pump and the motor must be kept clean in order to prevent excessive heat production. At normal operating temperatures, the heat generated by the pump rotation will not exceed 60 °C (140 °F). The surface temperature of the pump may, however, exceed 60° C (140 °F) if the temperature of the pumped medium is higher. When the unit is used in compliance with the ATEX standard, the maximum temperature of the medium is 70 °C (158 °F).

2.2 General description

Principle of operation

The pump's operation is based on the peristaltic effect: The cylindrical rotor, fitted with a bearing, compresses the hose during the 360-degree working cycle. The rotor is installed on a crankshaft that enables the eccentric movement; as the rotor rotates, it pushes the pumped medium forward in the hose.

After the rotor, the hose returns to its original shape, thus forming a vacuum within. The vacuum then refills with medium from the suction side. The hose compression is adjusted to prevent backflow through the point of compression.

Mechanical structure

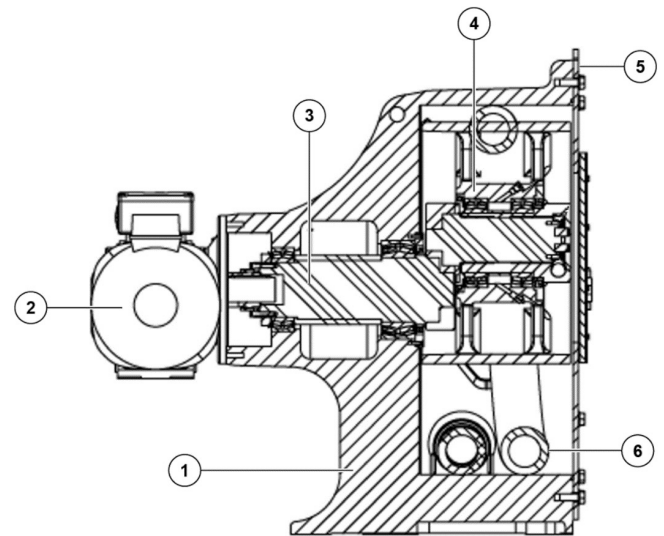

Figure 1. Main components of LPP-T pumps

1. Body
2. Drive unit
3. Crankshaft
4. Rotor assembly
5. Front cover
6. Hose

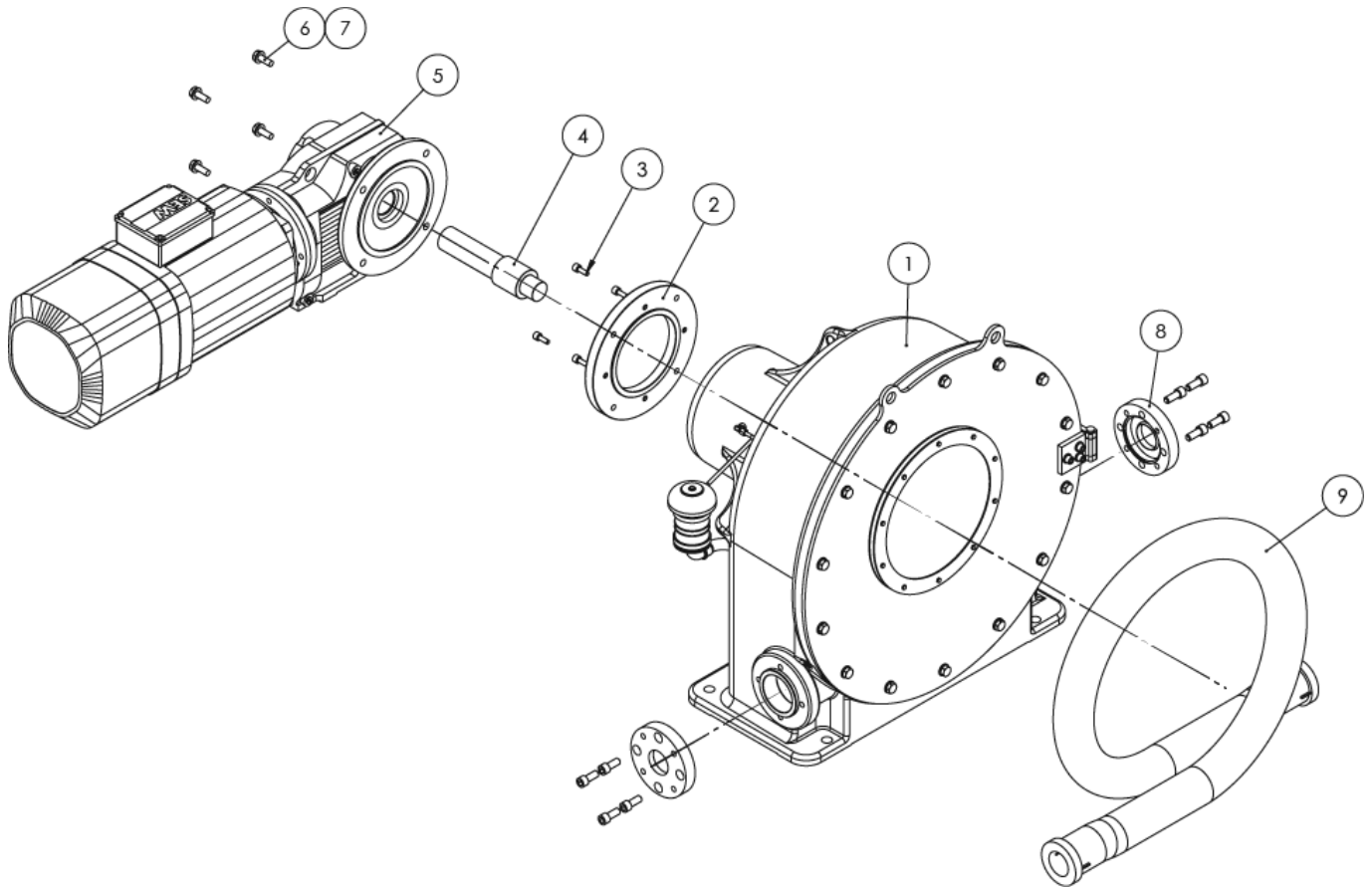

Figure 2. Exploded view of complete LPP-T pump

Item no.	Description	Qty
1	Pump head	1
2	Adapter flange	1
3	Screw	4
4	Drive shaft	1
5	Gear motor	1
6	Screw	4
7	Washer	4
8	Connector flange	2
9	Hose	1

All exploded parts are modular and order specific. Adapter parts vary depending on the selected gear motor.

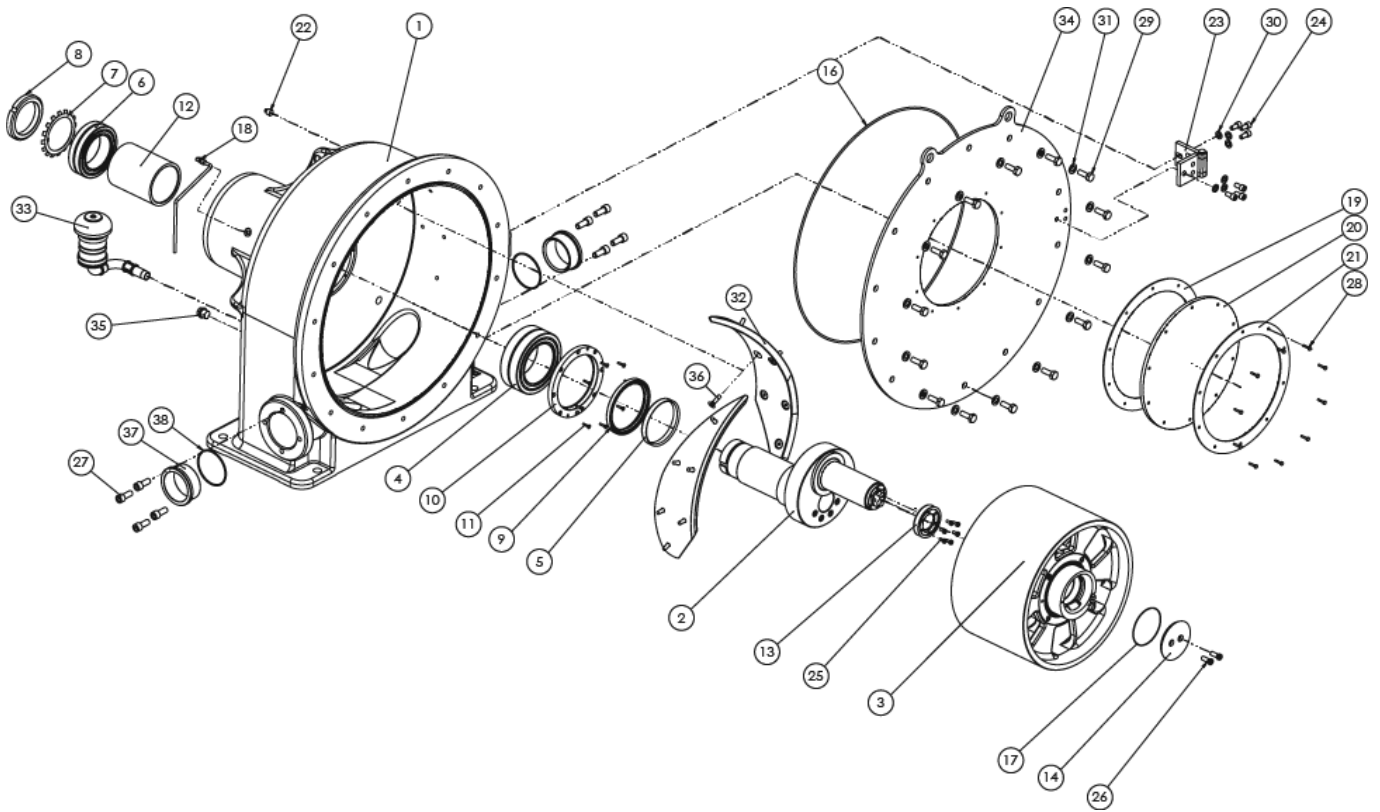

Figure 3. Exploded view of LPP-T pump head

Item no.	Description	Qty
1	Body	1
2	Crankshaft	1
3	Rotor assembly	1
4	Bearing	1
5	Wear ring	1
6	Bearing	1
7	Lock washer	1
8	Lock nut	1
9	Radial shaft seal	1
10	Locking ring	1
11	Countersunk screw	8
12	Bushing	1
13	Geared wheel	1
14	Locking cover	1
15	Grease nipple	1
16	O-ring	1
17	O-ring	1
18	Connector	1
19	Window seal	1
20	Front window	1
21	Reinforcement plate	1
22	Plug	1

Item no.	Description	Qty
23	Hinge	1
24	Hex socket screw	6
25	Socket screw	6
26	Hex socket screw	2
27	Hex socket screw	8
28	Hex screw	10
29	Hex screw	14
30	Washer	6
31	Washer	14
32	Hose guide	2
33	Breather set	1
34	Front cover	1
35	Hex plug	2
36	Countersunk screw	12
37	Hose bushing	2
38	O-ring	2

Parts and quantities may vary depending on the pump size.

The crankshaft has been attached with a bearing to the pole in the middle of the rear wall of the pump housing. The drive unit is connected to the pole with a flange.

The motor power is conveyed from the gearbox to the crankshaft via a coupling. A eccentric bushing is fitted with a bearing to the forward crank pin of the crankshaft, to which the hose compressing rotor is connected. When the drive unit rotates the crankshaft, the rotor rolls along the hose and compresses it at a set distance from the inner surface of the pump housing.

The only things changing with the pumped medium and flow parameters are the material for hose and connections as well as drive unit size.

The LPP-T pump can be equipped with one of two drive unit types:

- helical bewel gear (A)
- shaft-mounted gear (B)

Both drive unit options can be delivered with a solid gear motor, or a gear with an IEC flange for a motor with standard connections.

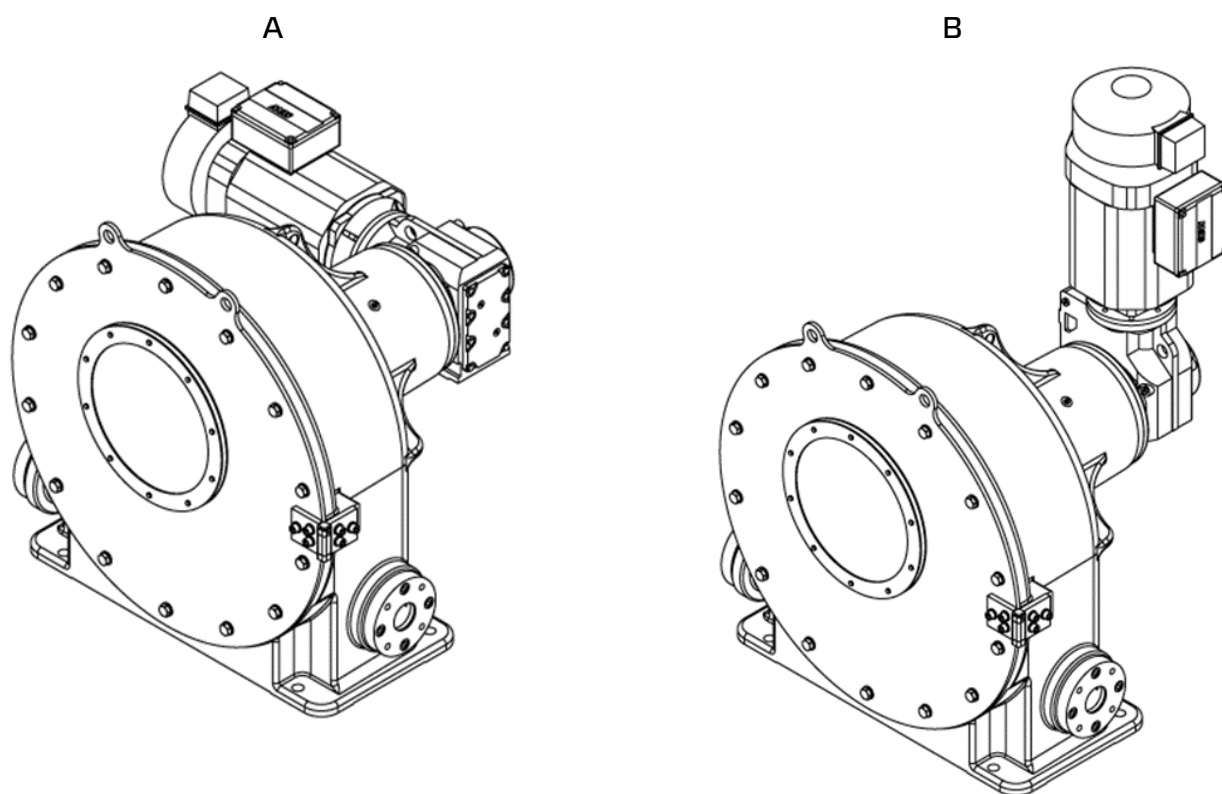

Figure 4. Pump drive unit options

2.3 Electrical equipment

Standard electrical equipment includes the following unless the pump is equipped with a vacuum assistant:

- hose leak detector

Optional electrical equipment can include the following:

- control cabinet
- pressure transmitter with display and overpressure limit
- revolution detector
- revolution counter and speed display (without wiring or box)

The control centre unit controls LPP-T pumps. The unit includes the following:

- frequency inverter
- required safety equipment
- reversing switch in stopping position
- fuses
- the possibility of connecting hose leak, overpressure, and revolution detectors

The electric motor can be operated with local speed control (potentiometer) connected to the control cabinet, or with remote control (4–20 mA or 0–10 V) using a control signal.

The **control cabinet** can be installed in connection with the pump or as a separate unit. If the control cabinet is delivered as a separate unit, it must be connected by a person authorised to perform electrical connections.

The **pressure transmitter**, which operates with a voltage of 24 V, is equipped with a display and a programmable overpressure relay. It can be connected to the drive circuit of the control cabinet with a pilot wire. If the programmed pressure value is exceeded, the control cabinet stops the pump automatically. The transmitter can be programmed directly with the buttons on the transmitter. After stopping, the pump can be restarted only through pressing of the acknowledgement button.

	WARNING!
	Electrocution hazard. All electrification connections must be made by professionals only.

The **hose leak detector** is installed outside the pump housing, on the back wall. The detector is a two-wire, float-type switch connected to the pump's drive circuit. If the hose is

punctured, the pumped medium starts leaking into the pump housing. When the surface of the liquid reaches the hose leak detector, the detector stops the rotation of the pump. Detector needs to be connected to a VFD or control cabinet.

If the detector is connected to a control cabinet supplied by Valmet Flow Control, the acknowledgement button must be pressed after a hose puncture. The pump can be restarted only after the button is pressed.

The **revolution detector** is an inductive sensor to be installed at the rear wall of the pump. It sends an impulse for each crankshaft rotation detected. The sensor requires an operating voltage of +24 V.

The revolution counter and/or speed display are installed on the door of the control cabinet. To operate, the counter and display require a power supply and the pulse data from the revolution detector. The counter is equipped with battery backup in case of power failure.

2.4 Technical data

Pump parameters

Table 1. Pump parameters.

Pump model	Maximum production m ³ /h (gpm)	Production per revolution litres (gallons)	Maximum pressure bar (psi)
LPP-T32 (LPP-T 1.25)	5.5 (24.2)	0.87 (0.23)	10 (145)
LPP-T40 (LPP-T 1.5)	8 (35.2)	1.25 (0.33)	10 (145)
LPP-T50 (LPP-T 2)	11.5 (51.0)	2.75 (0.73)	10 (145)
LPP-T65 (LPP-T 2.5)	20 (88.0)	5.4 (1.4)	10 (145)
LPP-T80 (LPP-T 3)	40 (176.0)	12.3 (3.2)	7.5 (108)

The maximum operating pressures of the LPP-T pump range vary from 7.5 to 10 bar. The pressure and flow produced by an individual pump depend on the dimensions of the drive unit.

	<p>In addition to drive unit dimensions, the pump output depends on the following factors:</p> <ul style="list-style-type: none">• the viscosity of the pumped medium• suction height
--	--

Dimensions and weights

The final dimensions and weight of the pump are determined in part by the pump drive unit and optional equipment installed.

The main pump dimensions are shown in the drawings on Appendix.

3 TRANSPORTATION, STORAGE AND LIFTING

LPP-T pumps are delivered in a transport container. Use the original container for storing and transporting the pump until the final installation. Store the pump and spare parts in a clean, dry and cool place protected from sunlight. Before unpacking the pump from the transport box, ensure that the pump foundation is finished and of the correct size and materials.

Pumps of certain sizes are delivered equipped with transport supports to ensure stability of the pumps. The transport supports must not be removed until the pump has been secured to its foundation. For further instructions, see Chapter 4: 'Installation.'

If the pump unit is stored for a long time after use, carry out the following procedures:

- Remove all medium from the pump hose.
- Remove the hose from the pump, or release the hose compression to prevent fatigue of the hose during storage.
- Clean the pump housing.
- Store the pump in a clean, dry and cool place $+5 - +20\text{ }^{\circ}\text{C}$ ($+41 - +68\text{ }^{\circ}\text{F}$) protected from sunlight.

	WARNING!
	Falling load hazard. Lift the pump only with approved lifting equipment of sufficient carrying capacity. Always follow the instructions of the lifting equipment manuals.

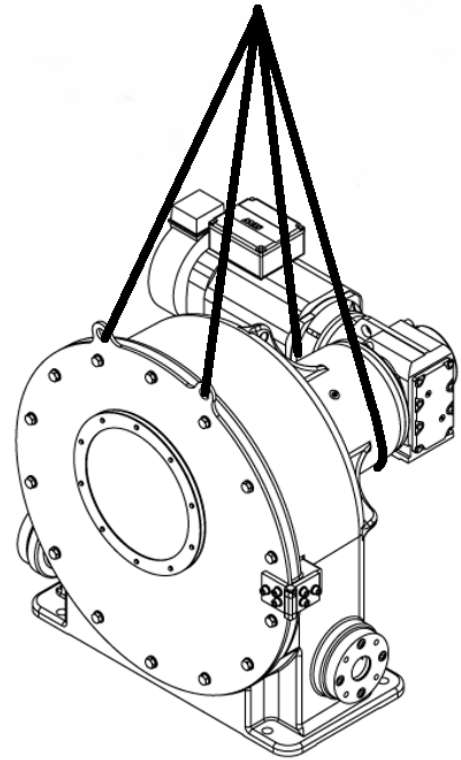



Figure 5. Hoisting the pump with drive unit

Do not attach lifting ropes to the lifting eye on the gearbox or the motor.

4 INSTALLATION

4.1 General

	LPP-T pumps are intended for use in industrial applications and facilities. They must be installed indoors and protected from direct sunlight, rain, and cold.
--	--

Only professional personnel with appropriate training are allowed to install an LPP-T pump. All installation and servicing tools and values are metric.

Tools needed for installation:

- fork wrench set
- allen wrench set
- torque wrench



Always tighten the bolts in a crosswise sequence and double check to make sure correct torque is reached.

The pump must be installed on the pedestal that is part of the pump body. If the pump is equipped with transport supports on delivery, the supports must not be removed until the pump has been secured on the installation foundation as instructed.

LPP-T pumps are delivered fully assembled and ready for use, and they are equipped with a drive unit (with the exception of so-called pump head deliveries that are ordered without the drive unit).

The following come as part of the installation for all pumps delivered to the customer by Valmet Flow Control Oy:

- hose, suitable for the purpose with LPP-T lubricant
- correct compression torque for the hose

4.2 Pump installation

It is recommendable to store the pump in its transport container until installation. See Chapter 3: 'Transportation, storage and lifting.'

Sufficient space must be left around the pump for maintenance work.

Note that the front cover is hinged and requires opening space.

Table 2. Minimum free distances around the pump and flatness requirements for the pump foundation.

Model	Front m (ft)	Right m (ft)	Left m (ft)	Behind m (ft)	Flatness requirement mm (in)
LPP-T32 & T40 (LPP-T 1.25 & T 1.5)	1 (3.3)	1 (3.3)	1 (3.3)	1 (3.3)	1 (0.04)
LPP-T50, T65 & T80 (LPP-T 2, T 2.5 & T 3)	1.5 (4.9)	1 (3.3)	1 (3.3)	1 (3.3)	2 (0.08)

The pump must be installed on a sufficiently strong foundation with fastening bolts or threads for fastening bolts. A sufficiently strong and level foundation for the pump must be built of either concrete or steel. The foundation must be higher than the floor level so that the pump does not get wet if water damages occur. The pump must be secured using the mounting holes on the pump base plate. Other types of securing are forbidden. Ensure that the carrying capacity of the foundation is sufficient, taking into consideration the weight of the pump and potential loads during use.



	The pump must be installed with the base plate downwards.
---	---

Table 3. Bolts for the pump foundation and their tightening torques.

Model	Bolt	Tightening torque (Nm)
LPP-T32, T40, T50, T65 & T80 (LPP-T 1.25, T 1.5, T 2, T 2.5 & T 3)	M24 x 70	660

	Always tighten the bolts in a crosswise sequence and double check to make sure correct torque is reached.
---	---

	CAUTION!
	Crushing hazard. Do not remove any transport supports before the pump has been secured to the foundation.

When the foundation is ready for installation, install the pump in the following order:

- Lift the pump onto the pedestal as instructed in Chapter 3.
- Fasten the pump in place with foundation bolts, and tighten the bolts to the torque given in Table 3 ('Bolts for the pump foundation and their tightening torques').
- Remove the transport supports, if any.

	If the pump is installed in dirty surroundings where its motor is susceptible to fluid splashes, or dust, the motor must be equipped with protection. An unclean motor can overheat and become damaged.
---	---

	For gear motors with an IEC flange, the motor is installed to the gear only after the pump has been secured to the foundation. The motor must be installed in accordance with the manufacturer's instructions.
---	--

4.3 Electrical connection

The motor connections must be performed in accordance with the manufacturer's instructions. The motor power supplies must be equipped in accordance with safety regulations, at least with maintenance and emergency stop switches, motor overload protection, and fuses.

	WARNING!
	Electrocution hazard. Before installation or maintenance, ensure that the supply voltage has been turned off. Only an authorised electrician is permitted to perform the required connection work.

4.4 Piping connections

General

The rotation direction set as standard for the pump is anticlockwise when the pump is viewed from the front (with the transparent maintenance window).

	Especially in pumping of heavy sludge, the minimum flow velocity must be taken into consideration, to prevent sedimentation of the medium.
---	--

Connected piping should meet the following requirements:

- To minimise pressure loss, the nominal size of the piping should be at least one size larger than the nominal size of the pump.
- The pump should be connected to the piping with flexible, pressure-proof hoses to facilitate maintenance work and to dampen the pressure shocks (pulsation) generated by the pump. The amount of pulsation (pressure change) depends on the following factors: the counter pressure of the piping, the capacity of the piping, the flow velocity, equipment installed in the piping, and the rotation speed of the pump.
- The strength of the pipeline supports should be taken into consideration, as the vibration in the piping may cause strain in the pump housing.
- If the pressure shocks of the pump disturb the pumping process, the pulsation can be dampened with special pulsation dampers installed in the pipeline.

- If there are closing valves on the discharge side of the pump, a pressure relief valve that prevents overpressure must be installed between the valve and the pump.

The discharge and suction connections of the pump consist of standard-compliant flange connection surfaces. Their boring is customer-specific. The lengths of the bolts required for the flange connection are given in Table 4 below.

Table 4. Fastening bolt lengths.

Model	Length of fastening bolt (mm)
LPP-T32, T40, T50, T65 & T80 (LPP-T 1.25, T 1.5, T 2, T 2.5 & T 3)	30 mm (1.18 in) + thickness of customer flange and gasket

- Starting the pump does not put personnel or equipment in danger.
- The pump is correctly connected to the piping and all connections are pressure-proof.
- The valves of all suction and pressure lines connected to the pump are open.
- The pump settings are correct.
- The amount of hose lubricant is sufficient.
- If the pump is equipped with a frequency inverter, the minimum frequency set is sufficient to ensure the cooling of the pump in all conditions. If the required minimum frequency is below 20 Hz, the pump must always be equipped with an additional cooling fan.

5 PUMP OPERATION

5.1 Commissioning

The LPP-T pumps are normally delivered with pre-installed hose and lubricant. Also the drive unit (gearbox and motor) is installed prior to the delivery of the pump. In this case, the pump is ready to be used with the nominal parameters indicated on the pump's type plate. Install the motor in accordance with the manufacturer's instructions if the pump is delivered without it (pump head delivery).

Pumps, size LPP-T50 (LPP-T 2) or bigger, delivered without frequency inverter need a soft starter to avoid coupling failures. This needs to be provided by the customer.

Before starting the pump, ensure that it has been installed in accordance with these instructions and applicable safety regulations.

At least the following must be ensured:

- The pump is used only for the purpose specified at the time of sale.
- The hose installed is compatible with the pumped medium.
- The parameters on the type plate are suitable for the process values required of the pump. The piping that the pump is connected to has sufficient ability to withstand pressure.
- The required pressure relief valves have been connected and work correctly.
- Electrical work has been carried out by an authorised electrician.

5.2 Operation

The continuous maximum operating speeds of the pumps are given in Table 5. If faster operating speeds are required, contact your nearest LPP-T pump representative.

Table 5. Maximum operating speeds.

Model	LPP-T32 (LPP-T 1.25)	LPP-T40 (LPP-T 1.5)	LPP-T50 (LPP-T 2)	LPP-T65 (LPP-T 2.5)	LPP-T80 (LPP-T 3)
Speed (rpm)	100	100	70	65	55

After starting, the pump starts rotating at its nominal speed (unless it is equipped with a frequency inverter). The nominal speed produces a nominal volume flow.

If the pump is equipped with a frequency inverter, the rotation speed of the pump depends on the value set for the frequency inverter. If the pump is controlled with a frequency inverter using slow rotation speeds, ensure that the pump motor does not overheat.

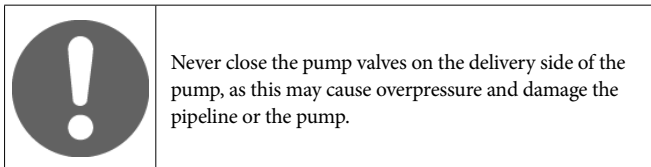

If the solid matter content of the pumped medium is high, the pipe lines must be flushed when the pump is stopped. This prevents the formation of blockages in the piping caused by sedimentation of the medium.

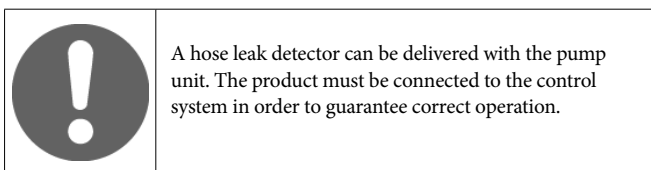

The need to replace the hose can be monitored during use of the pump by checking the volume flow of the pump and the pump velocity. If the volume flow per rotation is lower than the nominal production per rotation, the hose must be replaced.

6 SERVICING AND MAINTENANCE

6.1 General maintenance and checks

The process functions of peristaltic hose pumps are often critical. In order to guarantee problem-free and reliable operation, the pump must be monitored, and a basic check must be performed daily.

The hose used for transferring the pumped medium is the only part of the pump that requires regular replacement. Checking the condition of the hose is therefore the most important maintenance procedure for the pump. The most fundamental factor influencing the duration of the service life and the maintenance interval of the hose is correct adjustment of the hose compression.

In changing the hose, also replace the gasket rings used for sealing the hose and body through holes and to use the correct amount of LPP-T lubricant.

Observation during use

The condition of the pump hose must be checked regularly. Checking is done by visual estimation of the condition of the hose and by monitoring the flow meter parameters.

Observation of the pump condition on the basis of flow parameters is based on the volume flow produced by the pump and on the rotation speed of the pump. The volume flow (l/min) produced by the pump is divided by the rotation speed (rpm) of the pump. The resulting volume flow per revolution figure is compared with the equivalent figure of a new hose, or with the figure given in the pump's technical specifications.

The best result is achieved when the comparison is performed using the figure for a new hose. If the production per revolution is considerably less than the comparison figure (a difference of more than 5%), the hose compression must be adjusted. The volume flow produced by the pump depends on the properties of the pumped medium (viscosity, density, etc.), the suction height, etc. Reduced production per rotation indicates backflow is occurring via the compression point. The backflow can be compensated for by readjusting the hose compression (see Chapter 6.3, 'Adjusting the hose compression').

The condition of the gear unit and the bearing gaskets can

be checked visually for oil or grease leaks. If any leaks are detected, the gaskets (and bearings, if necessary) must be replaced.

The condition of the coupling between the pump and the gear can be determined by its sound. An abnormal pump operating sound may indicate a damaged bearing or coupling.

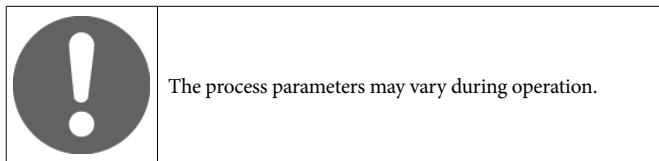
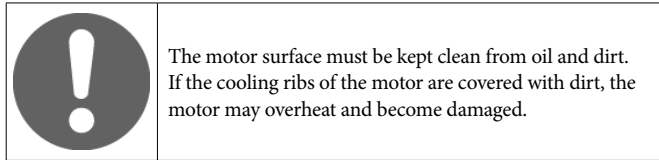

Spare parts

To ensure correct and quick delivery of spare parts, the order must contain at least the following information found on the type plate of the pump:

1. pump serial number
2. pump type
3. nominal production and pressure of the pump
4. manufacturing year of the pump

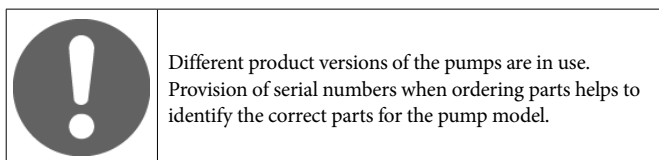

The pump parts, with corresponding number or code, can be found in the drawings at the end of this manual.

Lubrication

Lubricating the hose

LPP lubricants are used to reduce the friction between the hose and the rotor. The lubricants are classed into two different quality categories: food-grade quality and non-food-grade quality. The operating temperature range for original LPP hose lubricants is $-20\text{ }^{\circ}\text{C}$ to $100\text{ }^{\circ}\text{C}$ ($-4\text{ }^{\circ}\text{F}$ to $212\text{ }^{\circ}\text{F}$).

Check the correct amount of lubricant for your pump from Appendix.



	Before starting the pump, ensure that it is charged with lubricant.
---	---

	CAUTION!
	Always ensure that the lubricant is compatible with the pumped medium. Even if the LPP hose lubricant is extremely stable, it may react with oxidising substances, such as certain acids. In unclear situations, always contact your local Valmet Flow Control pump representative and ask for further information.

Lubricating the bearings

(See, in Appendix B, the section ‘Required grease additions’)

The pump unit bearings (rotor and body bearings) are greased for three months of normal operating conditions. Add 5% additional grease to the body bearings after every three months of operation (see Appendix B, section “Required amounts of LPP lubricant”). The suitable grease type for the bearings is SKF LGHP2 or equivalent.

	If the pump is used in abnormal conditions (high temperature or high relative air humidity), the grease may not last as long. In such cases, more frequent greasing is recommended to avoid bearing damage.
	Do not add too much grease to the bearings. It might force the seals out of their positions. Needed amount of grease depends about the hose replacement interval and pump utilization degree.

Lubricating the gearbox

The gearbox must be lubricated in accordance with the manufacturer’s instructions (delivered with the unit).

6.2 Changing the hose

Preparations

- Before starting maintenance work, clean the pump and the area around the pump. Ensure that the area is free from obstructions. Ensure no impurities can enter the pump.
- Before opening the piping assemblies flush and empty the pipelines via the flushing connections. Close all valves on the suction and delivery lines.

Ensure that the correct tools are available:

LPP-T32 (LPP-T 1.25)	
Allen key	10mm & 14mm
Combination spanner (flat/ ring)	10mm, 19mm & 24mm
Torque wrench with socket	13mm

LPP-T40 (LPP-T 1.5)	
Allen key	10mm & 14mm
Combination spanner (flat/ ring)	10mm, 19mm & 24mm
Torque wrench with socket	13mm

LPP-T50 (LPP-T 2)	
Allen key	10mm & 14mm
Combination spanner (flat/ring)	10mm, 19mm & 24mm
Torque wrench with socket	17mm

LPP-T65 (LPP-T 2.5)	
Allen key	10mm & 14mm
Combination spanner (flat/ ring)	10mm & 24mm
Torque wrench with socket	17mm

LPP-T80 (LPP-T 3)	
Allen key	10mm & 14mm
Combination spanner (flat/ ring)	13mm & 24mm
Torque wrench with socket	17mm

Glycerin (see APPENDIX)	
Hose	
O-rings (x 2)	
Hosepipe connected to water	

	Valmet Flow Control recommends that the hose change is done by two qualified people on the LPP-T50 (LPP-T 2), LPP-T65 (LPP-T 2.5) and LPP-T80 (LPP-T 3) pumps.
--	--

Removing the hose

	CAUTION!
	Do not allow unauthorised persons near the pump during maintenance work.

	CAUTION!
	Liquid inside the pump may be harmful to personnel and the environment. Use appropriate protective equipment. Comply with local waste treatment regulations.

1. Obtain a clearance certificate for maintenance and perform a lockout procedure. The pump must be stopped with the rotor in the bottom most position and turn the power off with the maintenance switch. The rotating of the rotor is meant to be done with the crank cam without electricity.
2. Remove the transparent maintenance window.
3. Discharge the lubricant from the pump via possible drainage valve or, alternatively, by opening the front cover. Protect yourself from splashes.
4. If the lubricant inside the pump was drained through a drainage valve, open the front cover by removing its fastening bolts.
5. With the front cover open, wash excess glycerine from pump housing.
6. Release the hose compression to the 0% position (read the instructions in Chapter 6.3 Adjusting the hose compression).
7. Remove piping connections on pump suction and discharge.
8. Open the connection flanges of the piping on both sides of the pump.
9. Remove the top of the hose from the pump housing by pulling it vigorously outwards.



The hose can be removed despite the plastic hose guides inside the housing (LPP-T65 and LPP-T80). Ensure that the hose is not squeezed between the hose guides and the rotating rotor during installation, as this may damage the hose.

A hose change crank cam is included with the pump delivery if the pump is delivered as a complete with gear and motor. The crank cam makes it possible to do the hose changing without electricity (excluding the special pump models). If there is no crank cam included in your pump delivery, please contact the authorized representative of Valmet Flow Control.

Motors with extended shaft

1. Remove the cover of extended shaft (refer to Figure 6 and Figure 7).

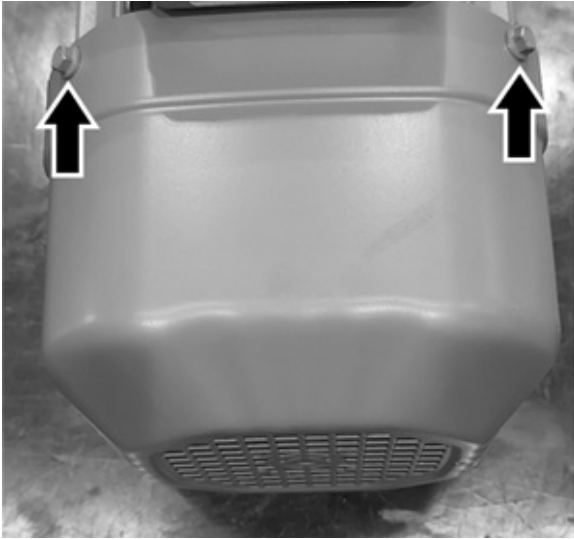

Figure 6.

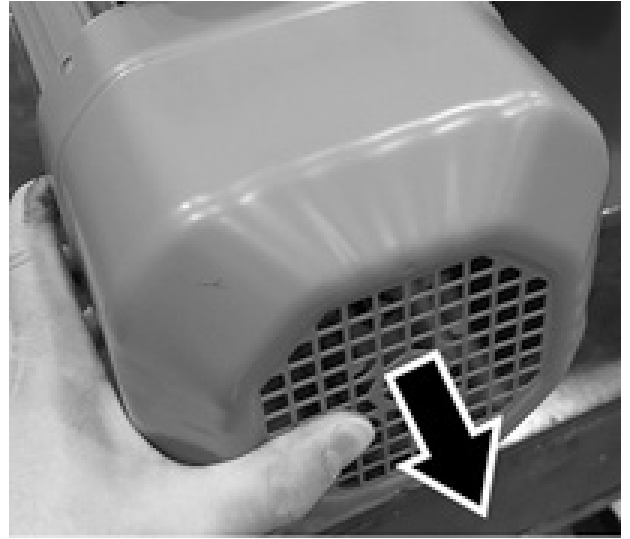

Figure 7.

2. Install the crank cam to the shaft situated in the back of the geared motor (refer to Figure 8 and Figure 9).

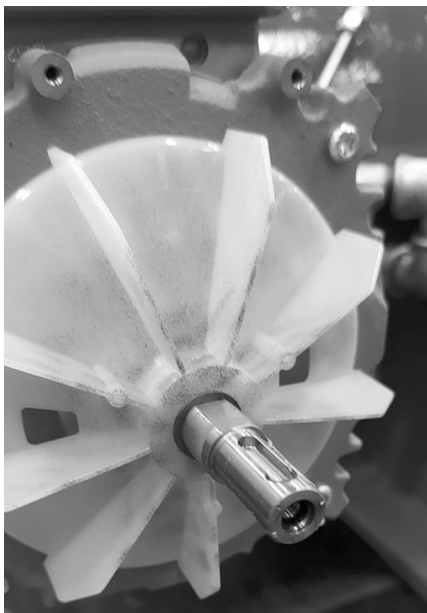



Figure 8.



Figure 9.

3. Turn the rotor to its topmost position with crank cam, ensuring that the top of the hose outside the pump does not re-enter the pump housing (refer to Figure 9).

	CAUTION!
	<p>Don't release the crank cam if the rotor is not in its lowest or highest position. Leaving the rotor in between position may cause the crank cam to rotate and cause personal injury.</p>

4. Pull both ends of the hose outward slightly from the pump housing and remove the gasket rings and the halves of the split bushing (refer to *Figure 10.* and *Figure 11.*).
5. After this, pull the ends of the hose through the through holes into the pump housing, from where the whole hose can be removed through the open front cover.
6. Clean the following parts carefully before installing the new hose:
 - pump housing
 - hose leak detector
 - breather

	<p>In the event of hose puncture, the hose leak detector and breather must be cleaned, to ensure correct operation of the LPP-T pump.</p>
---	---

	<p>Remove foreign particles from inside the pump housing. They may break the pump or significantly shorten the life of the hose.</p>
--	--



Figure 10.

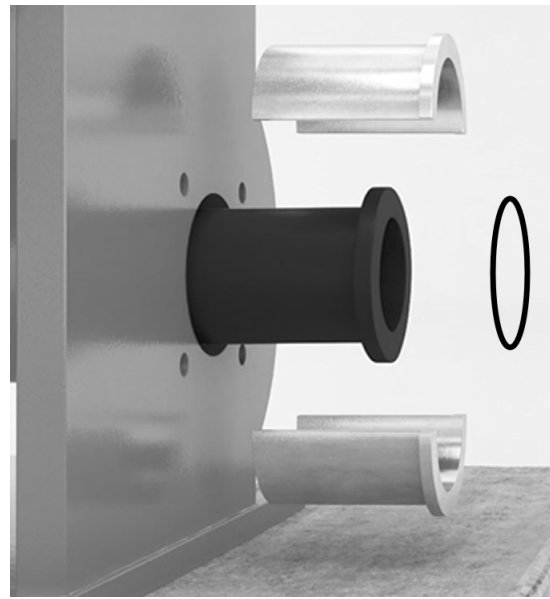

Figure 11.

Motors with extra cooling fan

1. Remove the cooling fan mounting bolts and the cooling fan.



Figure 12.

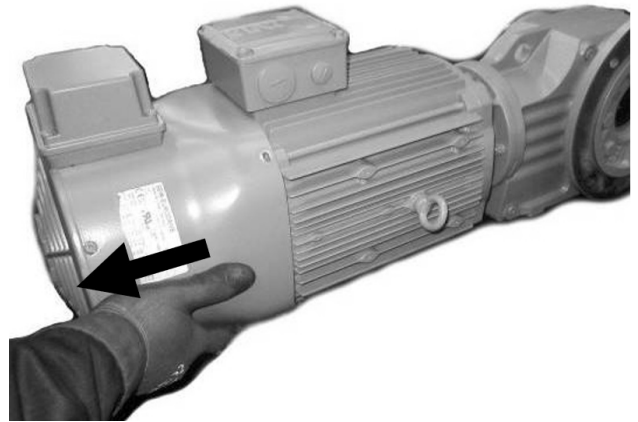

Figure 13.

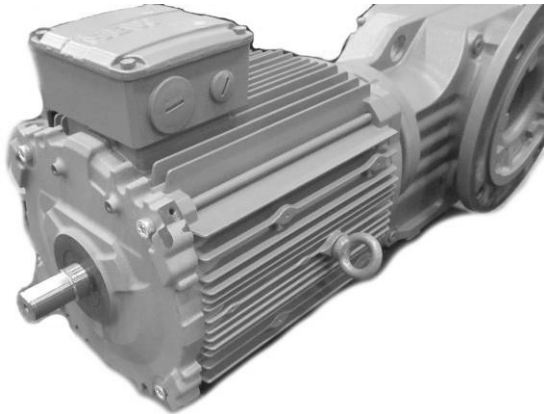

Figure 14.

2. Attach the crank cam to the motor shaft.

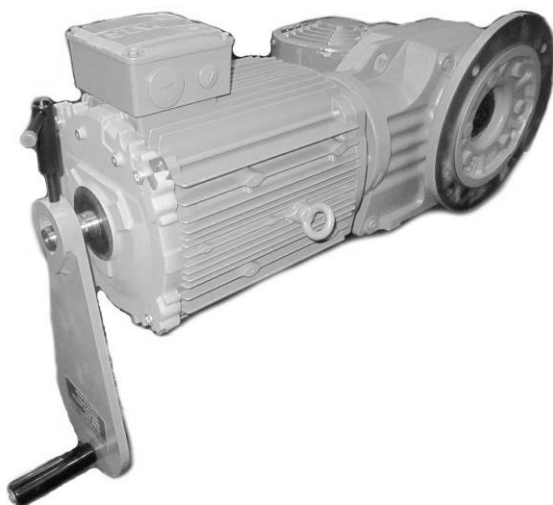

Figure 15.

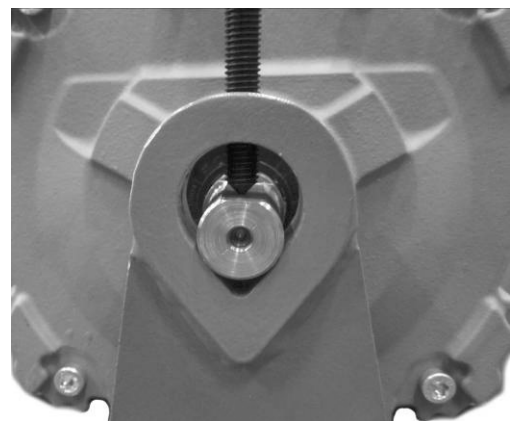



Figure 16.

3. Turn the rotor to its topmost position with crank cam, ensuring that the top of the hose outside the pump does not re-enter the pump housing.

	CAUTION!
	Impact hazard. Don't release the crank cam if the rotor is not in its lowest or highest position. Leaving the rotor in between position may cause the crank cam to rotate and cause personal injury.

4. Pull both ends of the hose outward slightly from the pump housing and remove the gasket rings and the halves of the split bushing (refer to *Figure 17.* and *Figure 18.*).
5. After this, pull the ends of the hose through the through holes into the pump housing, from where the whole hose can be removed through the open front cover.
6. Clean the following parts carefully before installing the new hose:
 - pump housing
 - hose leak detector
 - breather

	In the event of hose puncture, the hose leak detector and breather must be cleaned, to ensure correct operation of the LPP-T pump.
--	--

	Remove foreign particles from inside the pump housing. They may break the pump or significantly shorten the life of the hose.
--	---



Figure 17.

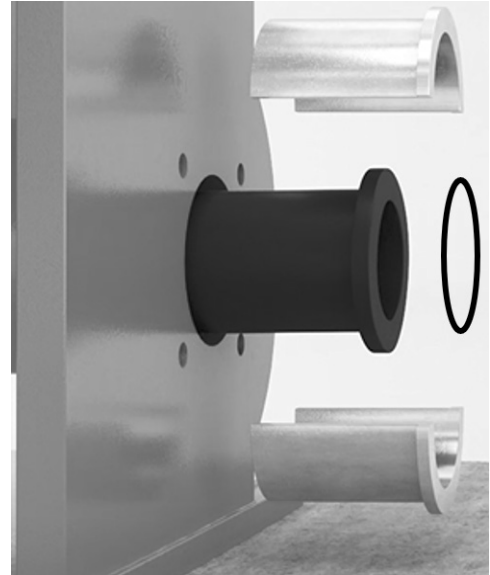



Figure 18.

Installing the hose

	<p>Do not allow unauthorised persons near the pump during maintenance work.</p>
--	---

Preparations

It is important to ensure that following parts are thoroughly cleaned prior to installation:

- Pump housing
- Hose leak detector
- Components such as bolts and flanges

Trim away any rubber flashings immediately behind the collar ends of the hose. This is necessary to ensure proper seating of the “O” ring.

Lubricate the hose thoroughly with glycerine before installing.

Be sure that the maintenance switch is in off position. The rotating of the rotor is meant to be done without electricity and with the crank cam.

1. Turn the rotor to its topmost position using the crank cam.
2. Ensure the hose compression adjustment is in the 0% position.

3. To facilitate installation, lubricate the through holes of the pump housing with LPP-T lubricant. Push both ends of the hose in through the through holes. For the hose to set correctly, the end of the hose must first be pushed through the rear through hole.
4. Push the ends of the hose through the through holes so that they are approximately 4 inches outside the body (refer to *Figure 19*).
5. Then install the halves of the split bushing behind the rubber flange of the hose so that the sealing gills are left between the halves (refer to *Figure 20*).
6. Install a gasket ring around the split bushing, behind the sleeve flange.
7. Push the ends of the hoses back inside the pump housing so that the flange of the split bushing is against the pump housing (refer to *Figure 21*).

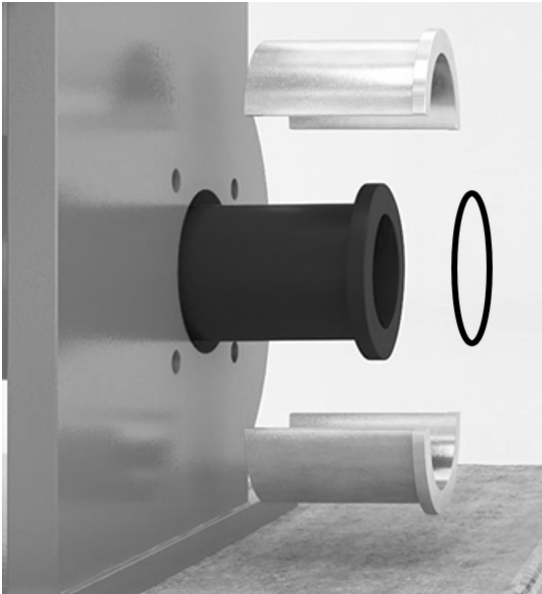

Figure 19.

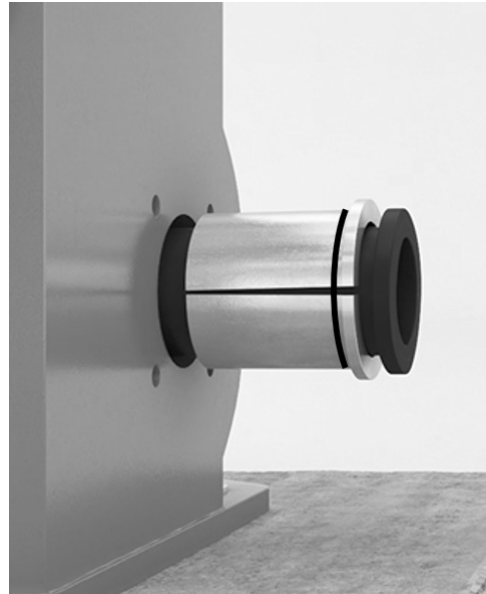
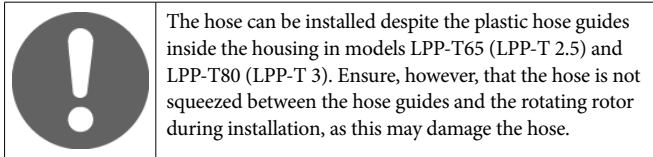

Figure 20.

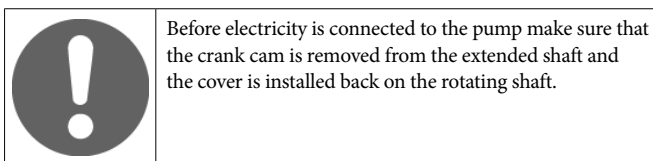

Figure 21.

8. Install the piping connection flanges in their places on the suction and discharge side of the pump but do not tighten the bolts.
9. Move the rotor to its lowest position (by rotating counter clockwise). Refer to Chapter 6.2.2.
10. Push the top of the hose inside the pump housing, behind the front hose guide.



11. Rotate the rotor slowly a few times so that the hose sets in the right position. **Important:** Ensure that the gap of the split bushing and the gasket gills are horizontal (refer to *Figure 21.*). Otherwise the hose will be subjected to excess tension, which may reduce its life time.
12. Tighten the piping connection flanges on both sides of the pump.
13. **Remove the crank cam from the motor shaft and install the cover of the extended shaft or extra cooling fan if applicable. (See Chapter 6.2.2)**
14. Close the front cover and pour the correct amount of LPP-T lubricant into the pump through the maintenance window. For the correct amount of lubricant see Appendix B.
15. Adjust the compression as instructed in Chapter 6.3.
16. Close the maintenance window and turn the maintenance switch to on position.



6.3 Adjusting the hose compression

Correct adjustment of the hose compression is the most important factor affecting the hose life time.

The adjustment is based on adjustment with an eccentric bushing.

The tightening torque values for the pump are given in Appendix.

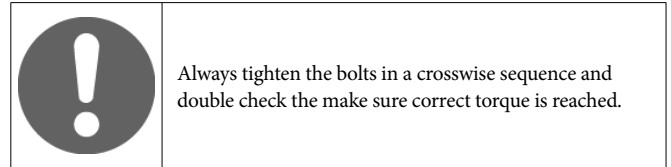

When adjusting the hose compression, check the nearest value from the table Appendix B for your application

1. Stop the pump so that the rotor remains in its topmost position and turn the power off via the maintenance switch. Lock the maintenance switch so that the pump cannot be switched on during the maintenance work.
2. Open the transparent maintenance window.
3. Release the locking cover by turning its locking screw(s) counter clockwise (refer to *Figure 22.*).



Figure 22.

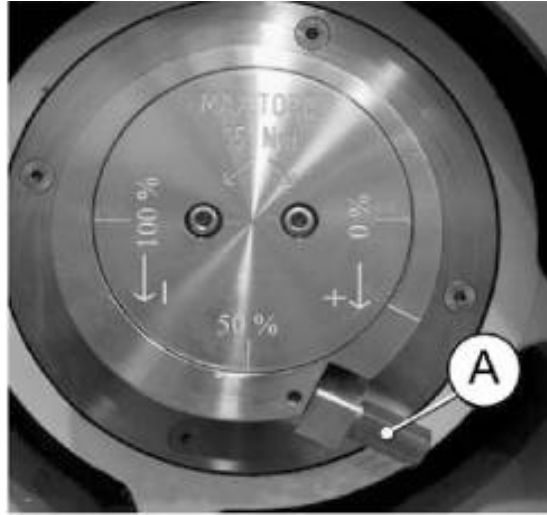



Figure 23.

(A = adjusting screw).

4. Turn the adjusting screw (refer to *Figure 23.*) with a torque wrench to the torque given in the table in Appendix B until the torque wrench indicates that the set torque has been reached.

	<p>When increasing the torque, turn the adjusting screw so that the adjustment bushing (and adjusting screw) turns to the direction of the “+” arrow on the locking cover.</p>
--	--

	<p>Do not turn the mark on the eccentric bushing over the “100%” mark on the locking cover. If a normal production per revolution figure or pressure production is not achieved and the compression adjustment is at the “100%” mark, change the hose.</p>
--	--



Figure 24.

5. Remove any grease and other particles from the conical surface of the adjustment bushing locking cover to ensure the grip of the locking cover.
6. Lock the locking cover with its fastening bolt by using a torque wrench in accordance with the values indicated in Appendix A, 'Tightening torques for LPP-T pumps' (refer to *Figure 24*).
7. Close the maintenance window.

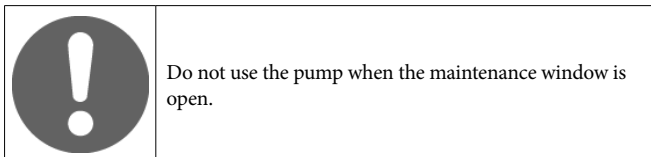

6.4 Maintenance

Assembling the rotor and removing the bearings

Before starting the following maintenance procedures, ensure that the required spare parts are ready at hand.

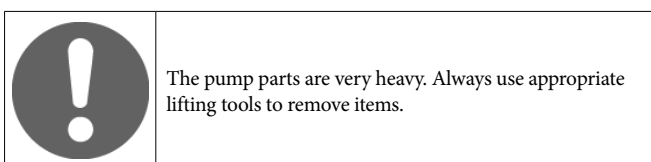

Removing the rotor and bearings

1. Turn the power off using the maintenance switch. Lock

the maintenance switch so that the pump cannot be switched on during the maintenance work.

2. Open the front cover. Remove the LPP-T lubricant inside the pump, and remove the hose as well.
3. Remove the locking cover of the adjustment bushing.
4. Remove the gearwheel from the end of the crankshaft. The locking pins remain on the end of the crankshaft.
5. Support the rotor well with a hoist or other lifting equipment and pull the rotor off the crank pin.

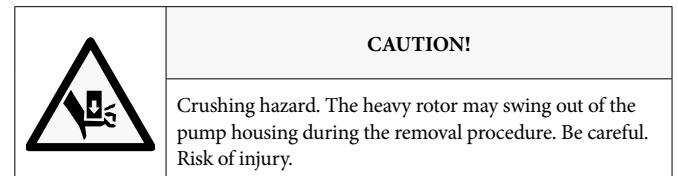

6. Push the adjustment bushing out from the rotor pole.
7. Remove the front support ring and its gaskets by removing the hex socket screws.
8. Remove the rear gasket and its support ring.
9. Remove the rear bearing and locking ring.
10. Remove the support bushing between the bearings.
11. Remove the front bearing.
12. Clean all parts carefully.

Installing the rotor and assembling the bearing application

1. Install the locking rings for the bearings (for models equipped with them).
2. Install the front bearing in its place.

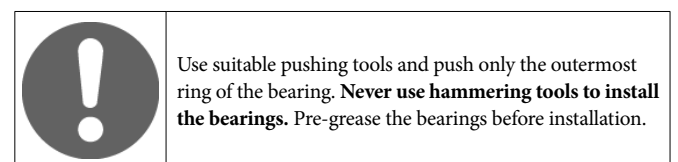

3. Install the gasket on the front support ring and mount the support ring on the rotor pole using countersunk hex socket screws.
4. Install the adjustment bushing onto the rotor pole using a pusher and install the bushing in its place.
5. Fill the bearing housing with bearing grease.
6. Install the rear bearing in its place.
7. Install the rear gasket onto the rotor pole by pushing.
8. Install the gasket ring behind the inner ribs of the rear bearing.

9. Install the sliding ring in its place.
10. Before installing the rotor, fit a sealing gasket ring on the crankshaft pin at the bottom of the neck.
11. Place the rotor into the crankshaft pin. Before the rotor reaches the bottom, install a gear wheel that affects the hose adjustment inside the adjustment bushing.
12. Push the rotor to the bottom. Grease the gear wheel lightly.
13. Remove any grease and other particles from the conical surface of the adjustment bushing locking cover to ensure the grip of the locking cover.
14. Install the gasket ring on the locking cover, and install the locking cover in its place.

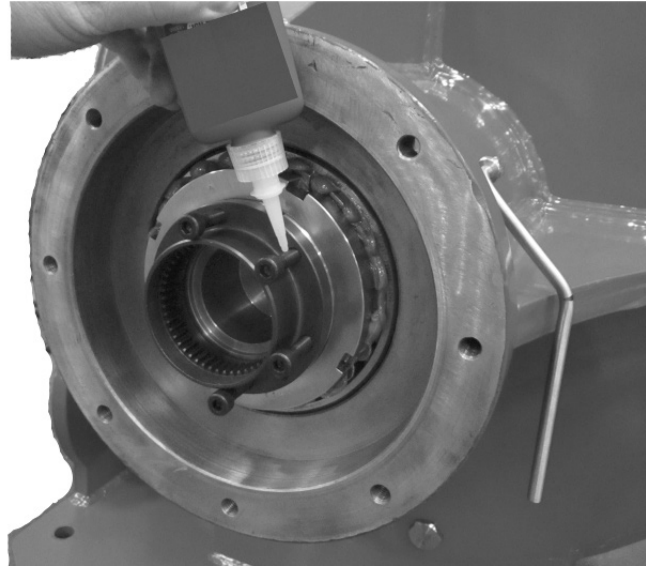

Figure 25. Coupling fastening bolts

Installing the gearbox and coupling

Remove the gearbox and coupling as follows:

1. Turn the power off and remove the cables (this must be done by a qualified electrician).
2. Support the gear unit with a hoist.
3. Remove the fastening bolts for the adapter flange.
4. Pull the gear unit off the pump and place it on a worktable.

Depending on the size of the pump, the coupling is either a claw coupling or a gear coupling. The gear unit has either a dead shaft or a hollow shaft with a separate stub shaft (large gears).

5. Remove the coupling from the gear unit shaft using an extractor.

The assembly is done in reverse order.

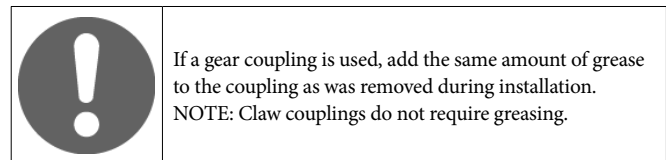
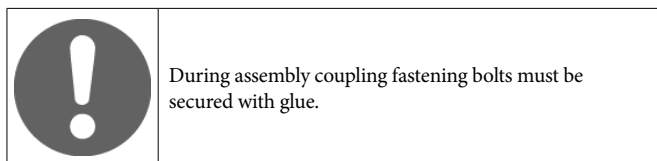



Removing and installing the crankshaft and bearings

Removing the crankshaft and bearings

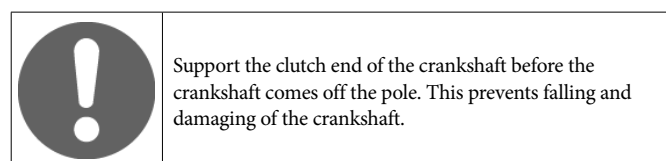
1. Turn the pump power off. Lock the maintenance switch so that the pump cannot be switched on during the maintenance work.
2. Remove the rotor from the end of the crankshaft as instructed above.
3. Remove the drive unit.
4. Unlock the spinner nut and screw it off.
5. Support the crankshaft from the end of the crank pin by screwing a lifting lug onto the end of the shaft and fastening it to the hoist. Push the crankshaft out of the pole.



	CAUTION!
	Crushing hazard. Risk of injury due to falling or uncontrollable swinging of the heavy crankshaft during removal.

	Use suitable pushing tools and push only the outermost ring of the bearing. Never use hammering tools to install the bearings. Pre-grease the bearings before installation.
---	--

6. Remove the fastening screws of the shaft seal support ring.
7. Remove the bearings and their outer rings by pushing them out of the pump pole.
8. Clean the parts.

Installing the crankshaft and bearings

1. Assemble the crankshaft following the removing instructions in reverse order.
2. Plan the order of installation carefully before starting.
3. Note that heating or cooling the parts to be installed makes the installation easier.
4. Pre-grease the bearings before installation.

	The cassette sealing/radial shaft seal of the crankshaft / body bearings and the support rings (see assembly drawings in Appendix) must be installed at the bottom of the crankshaft before installing the crankshaft inside the pump housing. Once the crankshaft has been installed, it is impossible to install the cassette sealing. It is recommended to apply sealing compound beneath the support ring. The fastening screws of the support ring can be tightened afterwards by rotating the crankshaft fitted with the frame bearings. Radial shaft seal need to be assembled spring out of the grease side.
	<p>a) When installing tapered roller bearings, the outer rings of the bearings are installed on the pump pole before installing the crankshaft. Install the inner ring of the front/housing-side tapered roller bearing and its roll on the crankshaft at the bottom before installing the crankshaft on the pump pole.</p> <p>b) Spherical roller bearings are installed as whole in the pump housing. (Contact Valmet Flow Control Oy for special tools to facilitate installation.)</p>

5. Tighten the rear bearing in place with a spinner nut and tighten the spinner nut to the torque given in Appendix A. Fill the bearing housing with bearing grease. Refer to the greasing instructions above to ensure correct operation of the pump.

	CAUTION!
	Falling load hazard. Always use suitable lifting equipment when handling the pump parts and follow the equipment manufacturer's instructions.

6.5 Troubleshooting

Table 6. Troubleshooting.

PROBLEM	POSSIBLE REASON	ACTION
The pump won't start.	The power is not on. The supply cable is not connected or is connected incorrectly. There is a power supply problem. Safety locking is on.	Turn the power on. Connect the supply cable (authorised electrician only). Check the power supply (authorised electrician only). Acknowledge the safety equipment.
The pump does not produce volume flow.	The suction valve is closed. The suction line is blocked.	Open the suction valve. Check the suction piping.
The pump does not produce full volume flow.	The viscosity or specific weight of the pumped medium is too high. The suction line is partly blocked. The hose compression is incorrect, resulting in backflow. The suction height is too high.	Check the measurement parameters of the pump and the properties of the medium. Clean the suction piping. Adjust the hose compression. Check the suction piping.
The hose life is short.	The hose compression is too high. Too little LPP-T lubricant has been used. There are loose particles in the medium that damage the hose.	Readjust the compression. Check the amount of lubricant. Prevent large particles from entering the pump.
Pump output drops in mid-operation.	The hose compression is incorrect, resulting in backflow. The suction piping is partly blocked.	Readjust the hose compression. Clean the suction piping.
The pump won't restart.	The pressure in the piping is too high. There is a blockage in the piping. There is a blockage in the pump hose.	Identify the cause of excessive pressure in the piping. Clean the piping. Clean or change the hose. Acknowledge the safety equipment.
There is medium in the pump housing.	The hose is leaking.	Clean the pump housing and change the hose.
The pump starts but stops shortly afterwards.	The supply cables have been connected incorrectly (star/delta connection).	Check the power supply (authorised electrician only).

APPENDIX A: Tightening torques for LPP-T pumps

Part code	Type	LPP-T32 (LPP-T1.25)	LPP-T40 (LPP-T1.5)	LPP-T50 (LPP-T2)	LPP-T65 (LPP-T2.5)	LPP-T80 (LPP-T3)
2295	DIN 933 M8 x 25					
70765	DIN 933 M6 x 20	7 Nm	7 Nm			
71127	DIN 6912 M6 x 20	7 Nm	7 Nm			
71726	DIN 7991 M6 x 20					
3450	DIN 912 M8 x 16					
7293	DIN 912 M12 x 45					
71616	DIN 7984 M8 x 30-8.8 Locking cover					
1573	DIN 933 M12 x 30	57 Nm	57 Nm	57 Nm		
71112	DIN 7991 M8 x 25				17 Nm	17 Nm
71115	DIN 7991 M6 x 25			7 Nm	7 Nm	
71116	DIN 912 M16 x 40			140 Nm	140 Nm	
71124	DIN 912 M12 x 25	57 Nm	57 Nm	57 Nm	57 Nm	
71317	DIN 6912 M12 x 16	57 Nm	57 Nm			
71618	DIN 7984 M12 x 40-8.8 Locking cover	50 Nm	50 Nm			
71352	DIN 6912 M8 x 20				17 Nm	
1583	DIN 933 M16 x 40				140 Nm	
2304	DIN 933 M16 x 30				140 Nm	
2292	DIN 933 M6 x 30			7 Nm	7 Nm	
71617	DIN 7984 Fe-M12 x 30-8.8 Locking cover			45 Nm	45 Nm	
3279	DIN 933 M6 x 16				7 Nm	
71732	DIN 7991 M12 x 30				57 Nm	
5494	DIN 912 M12 x 30			57 Nm	57 Nm	
71128	DIN 912 M8 x 40-12.9				40 Nm	
71722	DIN 6912 M12 x 30 Locking cover					45 Nm
71723	DIN 6912 M6 x 20					140 Nm
61999	DIN 931 M16 x 65					140 Nm
71721	DIN 912 M16 x 50					140 Nm
60214	DIN 912 M8 x 25					17 Nm
1576	DIN 933 M12 x 45			57 Nm		57 Nm
71724	DIN 912 M10 x 40-12.9					80 Nm
60216	DIN 912 M12 x 40					57 Nm
2495	DIN 912 M12 x 50					57 Nm
2304	DIN 933 M16 x 30					140 Nm

See the locations of parts via the enclosed assembly drawings.

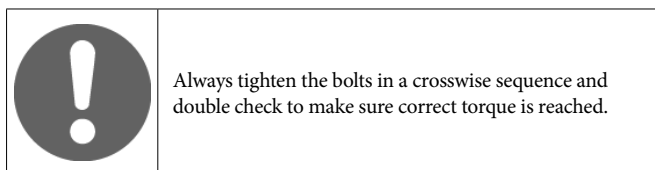

APPENDIX B: Required lubricant and compression torque values for LPP-T hoses

Required amounts of LPP lubricant:

Pump size	LPP-T32 (LPP-T 1.25)	LPP-T40 (LPP-T 1.5)	LPP-T50 (LPP-T 2)	LPP-T65 (LPP-T 2.5)	LPP-T80 (LPP-T 3)
Amount of lubricant litres (gallons)	2.5 (0.7)	2.5 (0.7)	5 (1.3)	5 (1.3)	10.0 (2.6)



The figures given in the table are minimum lubricant amounts. Larger amounts can be used, but in such cases the lubricant may leak through the breather piping of the housing, or the hose leak detector may not work correctly.

LPP hose lubricant	Code	Note
5 litres (1.3 gallons)	80066, foodgrade quality	Not to be used with oxidising substances
10 litres (2.6 gallons)	80067, foodgrade quality	Not to be used with oxidising substances
5 litres (1.3 gallons)	80232, foodgrade quality	Silicon (ATEX)
10 litres (2.6 gallons)	80233, foodgrade quality	Silicon (ATEX)

Required grease additions:

The bearings of the pump unit are greased by Valmet Flow Control Oy for three months of operation in normal conditions. Add 5% of grease to the frame bearings after every three months of operation. Add grease to the rotor bearings after each hose replacement. The suitable grease type for the bearings is SKF LGHP2 or equivalent.



Do not add too much grease to the bearings. It might force the seals out of their positions. Needed amount of grease depends about the hose replacement interval and pump utilization degree.

Pump size	LPP-T32 (LPP-T 1.25)	LPP-T40 (LPP-T 1.5)	LPP-T50 (LPP-T 2)	LPP-T65 (LPP-T 2.5)	LPP-T80 (LPP-T 3)
The amount of grease (5 %) to be added (grams) for frame bearings	35 (1.23 oz)	35 (1.23 oz)	40 (1.41 oz)	45 (1.59 oz)	70 (2.47 oz)

Pump size	LPP-T32 (LPP-T 1.25)	LPP-T40 (LPP-T 1.5)	LPP-T50 (LPP-T 2)	LPP-T65 (LPP-T 2.5)	LPP-T80 (LPP-T 3)
The amount of grease (5 %) to be added (grams) to the rotor	35 (1.23 oz)	35 (1.23 oz)	40 (1.41 oz)	45 (1.59 oz)	70 (2.47 oz)

Pump hose life time optimization:

	The following pump hose life time optimization values are tested with water.
---	--

LPP-T32-T40 (LPP-T 1.25 - T 1.5):

Flow Pressure	2,0 m ³ /h (8.8 gpm)	4,0 m ³ /h (17.6 gpm)	6,0 m ³ /h (26.4 gpm)	8,0 m ³ /h (35.2 gpm)
10 bars (150 psig)	20 Nm	20 Nm	25 Nm	30 Nm
8 bars (120 psig)	20 Nm	20 Nm	20 Nm	25 Nm
6 bars (90 psig)	20 Nm	20 Nm	20 Nm	20 Nm
4 bars (60 psig)	20 Nm	20 Nm	20 Nm	20 Nm
2 bars (30 psig)	10 Nm	20 Nm	20 Nm	20 Nm
0 bars (0 psig)	10 Nm	10 Nm	10 Nm	10 Nm

- Pressure adjusting value, Nm (on white background)

LPP-T50 (LPP-T 2):

Flow Pressure	3,5 m ³ /h (15.4 gpm)	5,5 m ³ /h (24.2 gpm)	7,5 m ³ /h (33.0 gpm)	9,5 m ³ /h (41.8 gpm)	11,5 m ³ /h (50.6 gpm)
10 bars (150 psig)	40 Nm	40 Nm	40 Nm	50 Nm	50 Nm
8 bars (120 psig)	30 Nm	30 Nm	30 Nm	40 Nm	40 Nm
6 bars (90 psig)	30 Nm	30 Nm	30 Nm	30 Nm	30 Nm
4 bars (60 psig)	20 Nm	20 Nm	20 Nm	20 Nm	20 Nm
2 bars (30 psig)	10 Nm	10 Nm	10 Nm	10 Nm	10 Nm

- Pressure adjusting value, Nm (on white background)

LPP-T65 (LPP-T 2-5):

Flow Pressure	4 m ³ /h (17.6 gpm)	8 m ³ /h (35.2 gpm)	12 m ³ /h (52.8 gpm)	16 m ³ /h (70.4 gpm)	20 m ³ /h (88.0 gpm)
10 bars (150 psig)	45 Nm	45 Nm	45 Nm	45 Nm	60 Nm
8 bars (120 psig)	30 Nm	30 Nm	30 Nm	30 Nm	45 Nm
6 bars (90 psig)	30 Nm	30 Nm	30 Nm	30 Nm	30 Nm
4 bars (60 psig)	15 Nm	15 Nm	15 Nm	15 Nm	15 Nm
2 bars (30 psig)	10 Nm	10 Nm	10 Nm	10 Nm	10 Nm
0 bars (0 psig)	10 Nm	10 Nm	10 Nm	10 Nm	10 Nm

- Pressure adjusting value, Nm (on white background)

LPP-T80 (LPP-T 3):

Flow Pressure	10 m³/h (44.0 gpm)	20 m³/h (88.0 gpm)	30 m³/h (132.0 gpm)	40 m³/h (176.0 gpm)
7,5 bars (108 psig)	120 Nm	120 Nm	120 Nm	120 Nm
5,5 bars (80 psig)	90 Nm	90 Nm	120 Nm	120 Nm
2,5 bars (35 psig)	90 Nm	90 Nm	90 Nm	90 Nm
0 bars (0 psig)	30 Nm	30 Nm	60 Nm	90 Nm

- Pressure adjusting value, Nm (on white background)

APPENDIX C: Hose leak detector chart

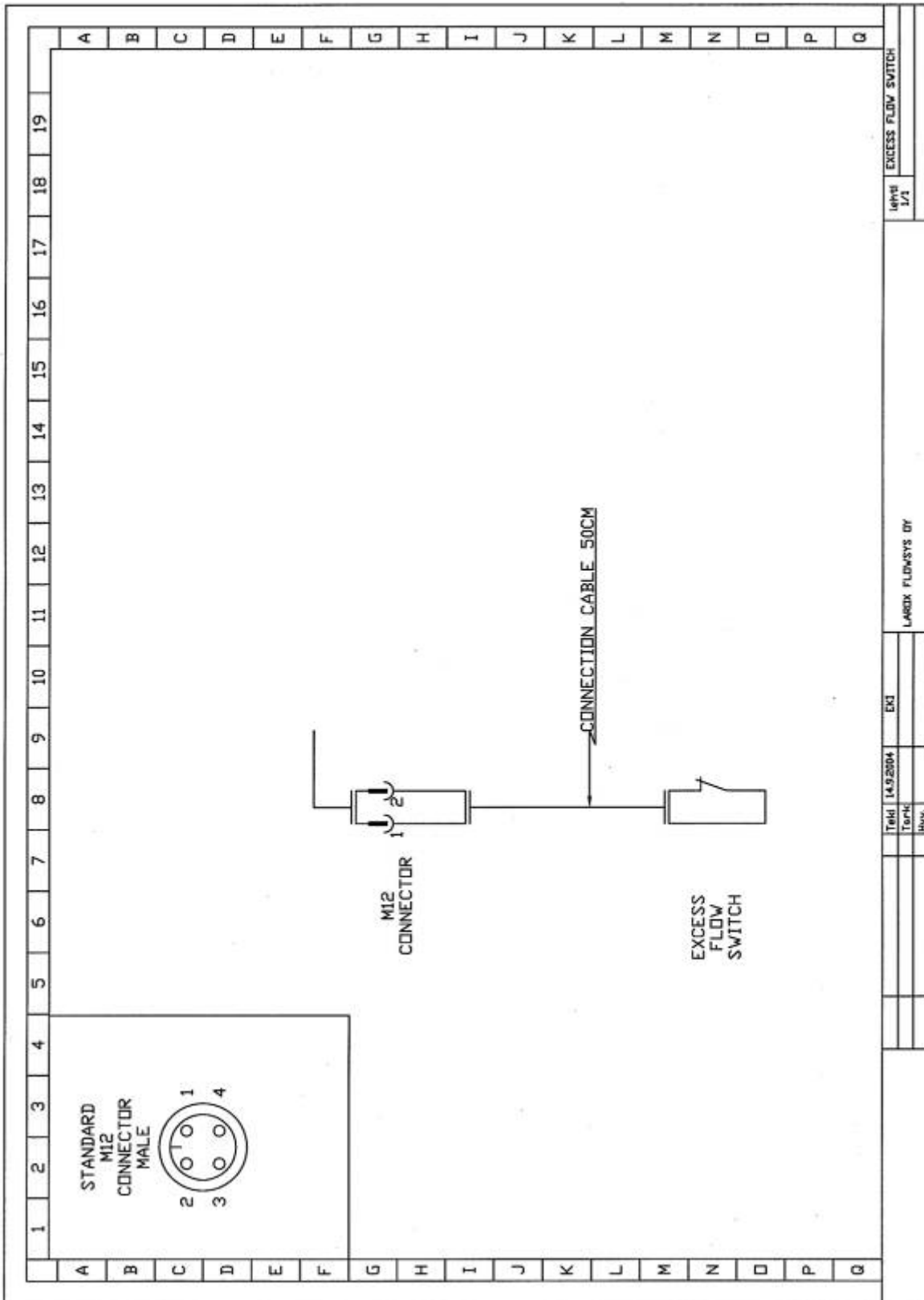

APPENDIX D: Claim form

The purchaser must file a claim for all compensation related to the hose and pump guarantee within 30 days after the fault has been detected.

The following information must be included. Fill in the form using block letters, or provide the manufacturer with the same information in another manner. In any instance, the claim must be made in writing.

PUMP SERIAL NUMBER:	
DATE WHEN THE FAULT WAS DETECTED (dd.mm.yyyy):	
OPERATING CONDITIONS IN WHICH THE FAULT WAS DETECTED:	
DESCRIPTION OF THE FLOWING MEDIUM:	
AN EXACT DESCRIPTION OF THE FAULT:	

If all of the above information is not sent to the manufacturer in writing, the purchaser loses the right of guarantee.

APPENDIX E: Dimensions, LPP-T pumps

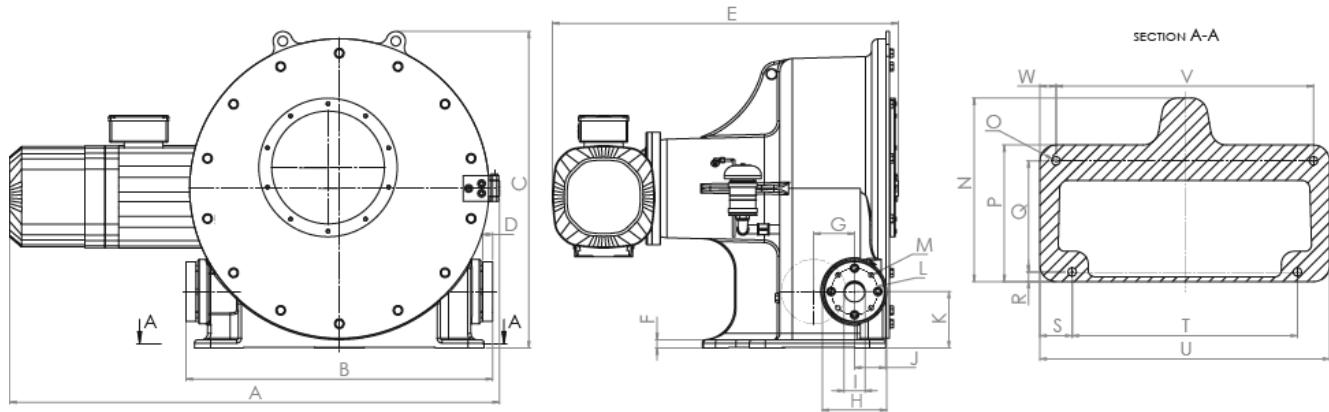

PUMP MODEL	A	B	C	D	E	F	G	H	I	J	K	L	M	N	O	P	Q	R	S	T	U	V	W
LPP-T32 (gear motor: SEW KF57, 3 kW)	941	652	664	31	724	21	90	150	32	65	130	DIN PN10 ANSI 150 AS TABLE E/D	DIN PN10 ANSI 150 AS TABLE E/D	394	26	296	220	38	80	440	600	440	80
LPP-T40 (gear motor: SEW KAF67, 5.5 kW)	1070	652	664	31	724	21	90	150	40	65	130	DIN PN10 ANSI 150 AS TABLE E/D	DIN PN10 ANSI 150 AS TABLE E/D	394	26	296	220	38	80	440	600	440	80
LPP-T50 (gear motor: SEW KAF87, 9.2 kW)	1381	928	878	45	1023	25	124	200	50	93	188	DIN PN10 ANSI 150 AS TABLE E/D	DIN PN10 ANSI 150 AS TABLE E/D	526	26	431	290	40	75	700	850	700	75
LPP-T65 (gear motor: SEW KAF87, 11 kW)	1522	952	982	31	1074	25	127	200	65	97	175	DIN PN10 ANSI 150 AS TABLE E/D	DIN PN10 ANSI 150 AS TABLE E/D	570	26	424	345	30	100	700	900	800	50
LPP-T80 (gear motor: SEW KAF107, 22kW)	1731	1140	1209	45	1286	35	201	250	80	133	223	DIN PN10 ANSI 150 AS TABLE E/D	DIN PN10 ANSI 150 AS TABLE E/D	720	26	520	440	40	40	1140	1220	1140	40

Dimensions with the largest available motor size.

Connector flange drillings options: DIN PN10, ANSI 150, AS TABLE E/D. Other drillings by request.

APPENDIX F: General safety warnings

Lifting

1. Always use a lifting plan created by a qualified person to lift this equipment. Lifting guidance is provided in this IMO (Installation, Maintenance and Operation manual) to assist in lifting plan development. Think about the center of gravity (CG) of the equipment being lifted. Make sure the CG is always under the central lifting point.
2. Use only correct and approved lifting devices. Ensure that lifting devices and straps are securely attached to the equipment prior to lifting.
3. Check, that lifting devices are not damaged and in good condition with a valid check stamp prior to use.
4. Workers must be trained for lifting and handling pumps.
5. Never lift an assembly by the instrumentation (drive unit). Failure to follow the lifting guidance provided may result in damage and personal injury from falling objects.

Work activities on the pump

1. Wear your personal safety equipment. Personal safety equipment includes but is not limited to protective shoes, protective clothing, safety glasses, helmet, hearing protection and working gloves.
2. Always follow the local safety instructions in addition to the Valmet instructions. If Valmet instructions conflict with local safety instructions, stop work and contact Valmet for more information.
3. Before beginning service on the equipment, make sure that the drive unit is disconnected from any kind of power source (hydraulic, and/or electric), and no stored energy is applied on the drive unit.
4. Make sure that there is a LOTOTO (Lock Out / Tag Out / Try Out) procedure in place for the system in which the pump is installed and strictly follow it.
5. Always make sure that the pipeline is depressurized and in ambient temperature condition before maintenance work is started.
6. Keep hands and other body parts out of the flow port when the pump is being serviced and the drive unit is connected to the pump. There is a high risk of serious injury to hands and/or fingers due to malfunction if the pump suddenly starts to operate.

General disclaimers

Recieve, handle and unpacking

1. Respect the safety warnings above!
2. Pumps are critical components for pipelines to control high pressure fluids and must therefore be handled with care.
3. Store pumps and equipment in a dry and protected area until the equipment is installed.
4. Do not exceed the maximum storage temperatures given in the IMO (installation, maintenance, and operating instructions).
5. Keep the original packaging on the pumps as long as possible to avoid environmental contamination by dust, water, dirt, etc.
6. FOR YOUR SAFETY IT IS IMPORTANT THE FOLLOWING PRECAUTIONS BE TAKEN PRIOR TO REMOVAL OF THE PUMP FROM THE PIPELINE OR BEFORE ANY DISASSEMBLY:
 - Be sure you know what fluid is in the pipeline. If there is any doubt, confirm with the proper supervisor.
 - Wear any personal protective equipment (PPE) required for working with the fluid involved in addition to any other PPE normally required.
 - Depressurize the pipeline, bring to ambient temperature, and drain the pipeline fluid.
 - Cycle the pump to relieve any residual pressure in the body cavity.
 - After removal but before disassembly, cycle the pump again until no evidence of trapped pressure remains.

Operating

1. The type plate (nameplate, or engraved markings) on the pump gives the information of max. process conditions to the pump.
2. Temperatures and pressures must never exceed values marked on the pump. Exceeding these values may cause uncontrolled release of pressure and process fluid. Damage or personal injury may result.
3. Valmet pumps typically are designed to be used in atmospheric conditions. Do not use pumps under external pressurized conditions unless specifically designed and explicitly marked for this service.
4. Avoid Pressure shocks or water hammer. Systems with high pressure pumps should be equipped with a bypass to reduce the differential pressure before opening the pump to avoid pressure shock.
5. Avoid thermal shock. High temperature, Low temperature pumps should be operated in a way that limits the rate of increase or decrease in temperature. The pump should be thermally stabilized before being pressurized.
6. Materials of the pump are carefully selected for the process conditions. Changes to the process media can have a major impact on function and safety of the pump. Always confirm the materials are suitable for the service prior to installation.
7. As the use of the pump is application specific, a number of factors should be taken into account when selecting a pump for a given application. Therefore, some situations in which the pumps are used are outside the scope of this manual.
8. It is the end user's responsibility to confirm compatibility of the pump materials with the intended service, however if you have questions concerning the use, application, or compatibility of the pump for the intended service, contact Valmet for more information.
9. Never use a pump with enriched or pure oxygen if the pump is not explicitly designed and cleaned for oxygen. Selected materials and design have a major impact on the safety to operate the pump with oxygen.
10. Pumps intended for use in or with explosive atmospheres must be equipped with a grounding device and marked according ATEX (or equivalent international standards).

Maintenance

1. Respect the safety warnings above!
2. Plan service and maintenance actions, that spare parts, lifting devices and service personnel is available.
3. Maintain the pump within the recommended minimum maintenance intervals or within the recommended maximum operating cycles.
4. Always make sure that the pump and the pipeline is depressurized before starting any kind of maintenance work at a pump.
5. Always check the position of the pump before starting maintenance work. Follow the Lock out /tag out (LOTO) rules at the site before starting any maintenance activity.
6. Sealing materials (soft sealing parts) should be changed when the pump is maintained. Always use original equipment manufacturers (OEM) spare parts to ensure proper performance of the repaired pump.
7. All pressure containing parts must be inspected visually for damage or corrosion. Damaged parts must be replaced.
8. Pump pressure bearing parts and all internals must be inspected for corrosion or erosion which may result in reduced wall thickness on pressure bearing parts. Damaged pressure bearing parts must be replaced with original equipment manufacturers (OEM) replacement parts or repaired to factory specifications by an authorized Valmet service partner in order to maintain the warrantee.
9. Do not use sharp tools, grinding machines, or files to work on functional surfaces such as sealing, seating or bearing surfaces as this can damage these surfaces.
10. Check the condition of sealing surfaces on the seats. Replace parts if there are significant wear, scratches, or damage.
11. Check the wear of bearings and bearing contact surfaces on the shaft and replace damaged parts if necessary.
12. Do not weld on pressure bearing parts without an ASME and PED qualified procedure and personnel.
13. Pressure bearing parts of pumps in high temperature applications must be carefully examined for the effects of material creep and fatigue.
14. Make sure that the pump is positioned in the correct flow direction into the pipeline.
15. If the pumps are marked to be suitable for explosive atmospheres, the correct function of the discharging device must be tested before returning to service.
16. Always work in a clean environment. Avoid getting particles inside the pump due to machining, grinding, or welding nearby.

17. Never store a maintained pump without flow port protection.
18. When pressure testing pumps, never exceed the maximum operating pressure of the system on the pump identification plate.
19. Drive unit mounting and unmounting:
 - Before installing the drive unit on to the pump, be sure the drive unit is properly indicating the pump position. Failure to assemble these to indicate correct pump position may result in damage or personal injury.
 - When installing or removing an adapter set, best practice is to remove the entire drive assembly, including couplings which may fall off the pump during lifting or when position changes.
 - Adapter sets have been designed to support the weight of the Valmet drive unit and recommended accessories. Use of the adapter sets to support additional equipment or additional weight such as people, ladders, etc. may result in equipment damage or personal injury.
20. The pump should be installed between flanges using appropriate gaskets and fasteners that are compatible with the application, and in compliance with applicable piping codes and standards. Center the gaskets carefully when fitting the pump between the flanges. Do not attempt to correct pipeline misalignment by means of the flange bolting.
21. Repairs on pump for special service like Oxygen, Chlorine, and Peroxide, have special requirements.
 - Parts must be cleaned appropriate to the service and protected from contamination prior to assembly.
 - Assembly areas and tools must be clean and dry to prevent contamination of the parts during assembly.
 - Test equipment must be clean and dry to prevent contamination during testing. This includes the test equipment internals that may allow particles or other contamination into the test fluid during the test.
 - Lubrication shall be used only if specifically required in the instructions. Where lubrication is required, the lubricant must be approved for the service by the end user.

Valmet Flow Control Oy

Marssitie 1, 53600 Lappeenranta, Finland.

Tel. +358 10 417 5000

www.valmet.com/flowcontrol

Subject to change without prior notice.

Neles, Neles Easyflow, Jamesbury, Stonel, Valvcon and Flowrox, and certain other trademarks, are either registered trademarks or trademarks of Valmet Oyj or its subsidiaries in the United States and/or in other countries.

For more information www.neles.com/trademarks

