

---

ABB GENERAL PURPOSE DRIVES

# ACS580 standard control program

## Firmware manual





Related documents are listed on page [15](#).

# Firmware manual

## ACS580 standard control program

### Table of contents



1. Introduction to the manual

### 2. Start-up, control with I/O and ID run



3. Control panel

4. Settings, I/O and diagnostics on the control panel

5. Control macros

6. Program features

7. Parameters

8. Additional parameter data

9. Fault tracing

10. Fieldbus control through the embedded fieldbus interface (EFB)

11. Fieldbus control through a fieldbus adapter

12. Control chain diagrams

Further information



# Table of contents

---

## **1. Introduction to the manual**

Contents of this chapter .....	13
Applicability .....	13
Safety instructions .....	13
Target audience .....	13
Purpose of the manual .....	14
Contents of this manual .....	14
Related documents .....	15
Cybersecurity disclaimer .....	20



## **2. Start-up, control with I/O and ID run**

Contents of this chapter .....	21
How to start up the drive .....	22
How to start up the drive using the First start assistant on the assistant control panel .....	22
How to control the drive through the I/O interface .....	33
How to perform the ID run .....	35
ID run procedure .....	36

## **3. Control panel**

Contents of this chapter .....	41
Removing and reinstalling the control panel .....	41
Layout of the control panel .....	42
Layout of the control panel display .....	43
Home view displays .....	45
Keys .....	46
Key shortcuts .....	47

## **4. Settings, I/O and diagnostics on the control panel**

Contents of this chapter .....	49
Primary settings menu .....	50
Macro .....	52
Motor .....	52
Start, stop, reference .....	54
Ramps .....	56
Limits .....	57
PID .....	58
Pump and fan control .....	60
Fieldbus .....	61
Advanced functions .....	63
Clock, region, display .....	66
Reset to defaults .....	67
I/O menu .....	69

---

## 6 Table of contents

Diagnostics menu .....	70
System info menu .....	71
Energy efficiency menu .....	73
Backups menu .....	75
Options menu .....	75

## 5. Control macros

Contents of this chapter .....	77
General .....	77
ABB standard macro .....	78
Default control connections for the ABB standard macro .....	78
ABB standard (vector) macro .....	80
Default control connections for the ABB standard (vector) macro .....	80
3-wire macro .....	82
Default control connections for the 3-wire macro .....	82
Alternate macro .....	84
Default control connections for the Alternate macro .....	84
Motor potentiometer macro .....	86
Default control connections for the Motor potentiometer macro .....	86
Hand/Auto macro .....	88
Default control connections for the Hand/Auto macro .....	88
Hand/PID macro .....	90
Default control connections for the Hand/PID macro .....	90
PID macro .....	92
Default control connections for the PID macro .....	92
Panel PID macro .....	94
Default control connections for the Panel PID macro .....	94
PFC macro .....	96
Default control connections for the PFC macro .....	96
Torque control macro .....	98
Default control connections for the Torque control macro .....	98
Parameter default values for different macros .....	100

## 6. Program features

What this chapter contains .....	107
Local control vs. external control .....	107
Local control .....	108
External control .....	109
Operating modes of the drive .....	112
Speed control mode .....	114
Torque control mode .....	114
Frequency control mode .....	114
Special control modes .....	115
Drive configuration and programming .....	116
Configuring via parameters .....	116
Adaptive programming .....	117
Control interfaces .....	121
Programmable analog inputs .....	121
Programmable analog outputs .....	121

---

Programmable digital inputs and outputs	121
Programmable frequency input and output	121
Programmable relay outputs	122
Programmable I/O extensions	122
Fieldbus control	123
Application control	123
Reference ramping	123
Constant speeds/frequencies	124
Critical speeds/frequencies	125
Speed controller autotune	126
User load curve	129
Control macros	130
Process PID control	131
PID trim function	135
Pump and fan control (PFC)	142
Timed functions	149
Motor potentiometer	150
Mechanical brake control	152
Motor control	156
Motor types	156
Motor identification	156
Scalar motor control	156
Vector motor control	157
Speed control performance figures	158
Torque control performance figures	159
Power loss ride-through	159
U/f ratio	159
Flux braking	160
DC magnetization	161
Energy optimization	164
Switching frequency	164
Rush control	165
Jogging	165
Speed compensated stop	168
DC voltage control	169
Overvoltage control	169
Undervoltage control (power loss ride-through)	169
Voltage control and trip limits	172
Brake chopper	175
Safety and protections	176
Fixed/Standard protections	176
Emergency stop	176
Motor thermal protection	177
Motor overload protection	182
Programmable protection functions	183
Automatic fault resets	185
Diagnostics	186
Signal supervision	186
Energy saving calculators	186
Load analyzer	187
Diagnostics menu	188



## 8 Table of contents

Miscellaneous .....	189
Backup and restore .....	189
User parameter sets .....	190
Data storage parameters .....	191
Parameter checksum calculation .....	191
User lock .....	192
Sine filter support .....	192

## 7. Parameters

What this chapter contains .....	195
Terms and abbreviations .....	196
Summary of parameter groups .....	197
Parameter listing .....	199
01 Actual values .....	199
03 Input references .....	202
04 Warnings and faults .....	203
05 Diagnostics .....	205
06 Control and status words .....	208
07 System info .....	214
10 Standard DI, RO .....	216
11 Standard DIO, FI, FO .....	225
12 Standard AI .....	226
13 Standard AO .....	231
15 I/O extension module .....	236
19 Operation mode .....	245
20 Start/stop/direction .....	247
21 Start/stop mode .....	257
22 Speed reference selection .....	266
23 Speed reference ramp .....	276
24 Speed reference conditioning .....	280
25 Speed control .....	280
26 Torque reference chain .....	286
28 Frequency reference chain .....	290
30 Limits .....	301
31 Fault functions .....	309
32 Supervision .....	319
34 Timed functions .....	327
35 Motor thermal protection .....	335
36 Load analyzer .....	346
37 User load curve .....	349
40 Process PID set 1 .....	353
41 Process PID set 2 .....	369
43 Brake chopper .....	371
44 Mechanical brake control .....	373
45 Energy efficiency .....	375
46 Monitoring/scaling settings .....	379
47 Data storage .....	383
49 Panel port communication .....	384
50 Fieldbus adapter (FBA) .....	386
51 FBA A settings .....	390





52 FBA A data in	392
53 FBA A data out	392
58 Embedded fieldbus	393
71 External PID1	400
76 PFC configuration	403
77 PFC maintenance and monitoring	411
95 HW configuration	412
96 System	415
97 Motor control	425
98 User motor parameters	429
99 Motor data	431
Differences in the default values between 50 Hz and 60 Hz supply frequency settings	437
Parameters supported by Modbus backwards compatibility with 550	439

## 8. Additional parameter data



What this chapter contains	443
Terms and abbreviations	443
Fieldbus addresses	444
Parameter groups 1...9	445
Parameter groups 10...99	448

## 9. Fault tracing

What this chapter contains	479
Safety	479
Indications	479
Warnings and faults	479
Pure events	480
Editable messages	480
Warning/fault history	480
Event log	480
Viewing warning/fault information	481
QR code generation for mobile service application	481
Warning messages	482
Fault messages	493

## 10. Fieldbus control through the embedded fieldbus interface (EFB)

What this chapter contains	505
System overview	505
Connecting the drive to the fieldbus	507
Setting up the embedded fieldbus interface	508
Setting the drive control parameters	509
Basics of the embedded fieldbus interface	511
Control word and Status word	512
References	512
Actual values	512
Data input/outputs	512
Register addressing	512
About the control profiles	514

## 10 Table of contents

Control Word	515
Control Word for the ABB Drives profile	515
Control Word for the DCU Profile	516
Status Word	519
Status Word for the ABB Drives profile	519
Status Word for the DCU Profile	520
State transition diagrams	522
State transition diagram for the ABB Drives profile	522
References	525
References for the ABB Drives profile and DCU Profile	525
Actual values	526
Actual values for the ABB Drives profile and DCU Profile	526
Modbus holding register addresses	527
Modbus holding register addresses for the ABB Drives profile and DCU Profile	527
Modbus function codes	528
Exception codes	529
Coils (0xxxx reference set)	530
Discrete inputs (1xxxx reference set)	532
Error code registers (holding registers 400090...400100)	534

## 11. Fieldbus control through a fieldbus adapter

What this chapter contains	535
System overview	535
Basics of the fieldbus control interface	537
Control word and Status word	538
References	539
Actual values	540
Contents of the fieldbus Control word (ABB Drives profile)	541
Contents of the fieldbus Status word (ABB Drives profile)	543
The state diagram (ABB Drives profile)	544
Setting up the drive for fieldbus control	545
Parameter setting example: FPBA (PROFIBUS DP) with ABB Drives profile	546
Automatic drive configuration for fieldbus control	548

## 12. Control chain diagrams

Contents of this chapter	551
Frequency reference selection	552
Frequency reference modification	553
Speed reference source selection I	554
Speed reference source selection II	555
Speed reference ramping and shaping	556
Speed error calculation	557
Speed feedback	558
Speed controller	559
Torque reference source selection and modification	560
Reference selection for torque controller	561
Torque limitation	562
Process PID setpoint and feedback source selection	563
Process PID controller	564



External PID setpoint and feedback source selection .....	565
External PID controller .....	566
Direction lock .....	567
PID trim auto connection .....	568

**Further information**







# Introduction to the manual

---

## Contents of this chapter

The chapter describes applicability, target audience and purpose of this manual. It also describes the contents of this manual and refers to a list of related manuals for more information.

## Applicability

The manual applies to the ACS580 standard control program ASCKX version 2.11. ASCK2 is used for frame sizes R1...R5, and ASCK4 is used for frames sizes R6...R11.

To check the firmware version of the control program in use, see system information (select **Menu - System info - Drive**) or parameter [07.05 Firmware version](#) (see page [214](#)) on the control panel.

## Safety instructions

Follow all safety instructions.

- Read the **complete safety instructions** in the *Hardware manual* of the drive before you install, commission, or use the drive.
- Read the **firmware function-specific warnings and notes** before changing parameter values. These warnings and notes are included in the parameter descriptions presented in chapter [Parameters](#) on page [195](#).

## Target audience

The reader is expected to know the fundamentals of electricity, wiring, electrical components and electrical schematic symbols.

---

The manual is written for readers worldwide. Both SI and imperial units are shown. Special US instructions for installations in the United States are given.

## **Purpose of the manual**

This manual provides information needed for designing, commissioning, or operating the drive system.

## **Contents of this manual**

The manual consists of the following chapters:

- *Introduction to the manual* (this chapter, page 13) describes applicability, target audience, purpose and contents of this manual. At the end, it lists terms and abbreviations.
  - *Start-up, control with I/O and ID run* (page 21) describes how to start up the drive as well as how to start, stop, change the direction of the motor rotation and adjust the motor speed through the I/O interface.
  - *Control panel* (page 41) contains instructions for removing and reinstalling the assistant control panel and briefly describes its display, keys and key shortcuts.
  - *Settings, I/O and diagnostics on the control panel* (page 49) describes the simplified settings and diagnostic functions provided on the assistant control panel.
  - *Control macros* (page 77) contains a short description of each macro together with a connection diagram. Macros are pre-defined applications which will save the user time when configuring the drive.
  - *Program features* (page 107) describes program features with lists of related user settings, actual signals, and fault and warning messages.
  - *Parameters* (page 195) describes the parameters used to program the drive.
  - *Additional parameter data* (page 443) contains further information on the parameters.
  - *Fieldbus control through the embedded fieldbus interface (EFB)* (page 505) describes the communication to and from a fieldbus network using the drive embedded fieldbus interface with the Modbus RTU protocol.
  - *Fieldbus control through a fieldbus adapter* (page 535) describes the communication to and from a fieldbus network using an optional fieldbus adapter module.
  - *Fault tracing* (page 479) lists the warning and fault messages with possible causes and remedies.
  - *Control chain diagrams* (page 551) describes the parameter structure within the drive.
  - *Further information* (inside of the back cover, page 569) describes how to make product and service inquiries, get information on product training, provide feedback on ABB Drives manuals and find documents on the Internet.
-

## Related documents

You can find manuals and other product documents in PDF format on the Internet. See section Document library on the Internet on the inside of the back cover. For manuals not available in the Document library, contact your local ABB representative

<b>Drive manuals and guides</b>	<b>Code (English)</b>
<i>Drive/converter/inverter safety instructions</i>	<a href="#">3AXD50000037978</a>
<i>ACS580-01 (0.75 to 250 kW, 1.0 to 350 hp) hardware manual</i>	<a href="#">3AXD50000044794</a>
<i>ACS580-01 frames R1 to R5 quick installation and start-up guide</i>	<a href="#">3AXD50000044838</a>
<i>ACS580-01 frames R6 to R9 quick installation and start-up guide</i>	<a href="#">3AXD50000009286</a>
<i>ACS580-04 drive modules (250 to 500 kW) hardware manual</i>	<a href="#">3AXD50000015497</a>
<i>ACS580-04 modules (250 to 500 kW) quick installation guide</i>	<a href="#">3AXD50000015469</a>
<i>ACS580-07 drives (75 to 500 kW) hardware manual</i>	<a href="#">3AXD50000045815</a>
<i>ACx-AP-x assistant control panels user's manual</i>	<a href="#">3AUA0000085685</a>
<i>ACS-BP-S basic control panels user's manual</i>	<a href="#">3AXD50000032527</a>
<b>Option manuals and guides</b>	<b>Code (English)</b>
<i>ACS580, ACH580 and ACQ580 drive module frames R3 and R5 to R9 for cabinet installation (options +P940 and +P944) supplement</i>	<a href="#">3AXD50000210305</a>
<i>ACS580-01, ACH580-01 and ACQ580-01 installation guide for UK gland plate (option +H358)</i>	<a href="#">3AXD50000034735</a>
<i>CPTC-02 ATEX-certified thermistor protection module, Ex II (2) GD (+L537+Q971) user's manual</i>	<a href="#">3AXD50000030058</a>
<i>CDPI-01 communication adapter module user's manual</i>	<a href="#">3AXD50000009929</a>
<i>DPMP-01 mounting platform for control panels</i>	<a href="#">3AUA0000100140</a>
<i>DPMP-02/03 mounting platform for control panels</i>	<a href="#">3AUA0000136205</a>
<i>DPMP-04 and DPMP-05 mounting platform for control panels</i>	<a href="#">3AXD50000308484</a>
<i>FCAN-01 CANopen adapter module user's manual</i>	<a href="#">3AFE68615500</a>
<i>FCNA-01 ControlNet adapter module user's manual</i>	<a href="#">3AUA0000141650</a>
<i>FDNA-01 DeviceNet™ adapter module user's manual</i>	<a href="#">3AFE68573360</a>
<i>FECA-01 EtherCAT adapter module user's manual</i>	<a href="#">3AUA0000068940</a>
<i>FEIP-21 Ethernet/IP adapter module user's manual</i>	<a href="#">3AXD50000158621</a>
<i>FENA-01/-11/-21 Ethernet adapter module user's manual</i>	<a href="#">3AUA0000093568</a>
<i>FEPL-02 Ethernet POWERLINK adapter module user's manual</i>	<a href="#">3AUA0000123527</a>
<i>FMBT-21 Modbus/TCP adapter module user's manual</i>	<a href="#">3AXD50000158607</a>
<i>FPBA-01 PROFIBUS DP adapter module user's manual</i>	<a href="#">3AFE68573271</a>

<i>FPNO-21 PROFINET adapter module user's manual</i>	<a href="#">3AXD50000158614</a>
<i>FSCA-01 RS-485 adapter module user's manual</i>	<a href="#">3AUA0000109533</a>
<i>FSPS-21 Safety functions fieldbus module user's manual</i>	<a href="#">3AXD50000158638</a>
<i>ACS580-01..., ACH580-01... and ACQ580-01...+C135 drives with flange mounting kit supplement</i>	<a href="#">3AXD50000019100</a>
<i>ACS580-01..., ACH580-01... and ACQ580-01...+C135 frames R1 to R3 flange mounting kit quick installation guide</i>	<a href="#">3AXD50000119172</a>
<i>ACS580-01..., ACH580-01... and ACQ580-01...+C135 frames R4 to R5 flange mounting kit quick installation guide</i>	<a href="#">3AXD50000287093</a>
<i>ACS880-01..., ACS580-01..., ACH580-01... and ACQ580-01...+C135 frames R6 to R9 flange mounting kit quick installation guide</i>	<a href="#">3AXD50000019099</a>
<i>Main switch and EMC C1 filter options (+F278, +F316, +E223) installation supplement for ACS580-01, ACH580-01 and ACQ580-01 frames R1 to R5</i>	<a href="#">3AXD50000155132</a>
<i>UL Type 12 hood quick installation guide for ACS580-01, ACH580-01 and ACQ580-01 frames R1 to R9</i>	<a href="#">3AXD50000196067</a>

<b>Tool and maintenance manuals and guides</b>	<b>Code (English)</b>
<i>Drive composer PC tool user's manual</i>	<a href="#">3AUA0000094606</a>
<i>Converter module capacitor reforming instructions</i>	<a href="#">3BFE64059629</a>
<i>NETA-21 remote monitoring tool user's manual</i>	<a href="#">3AUA00000969391</a>
<i>NETA-21 remote monitoring tool installation and start-up guide</i>	<a href="#">3AUA0000096881</a>

The code(s) below open online listings of the manuals applicable to the products.



[ACS580-01 manuals](#)



[ACS580-04 manuals](#)



[ACS580-07 manuals](#)



## Terms and abbreviations

Term/abbreviation	Explanation
ACS-BP-S	Basic control panel, basic operator keypad for communication with the drive.
ACX-AP-x	Assistant control panel, advanced operator keypad for communication with the drive.  The ACS580 supports types ACS-AP-I, ACS-AP-S and ACS-AP-W (with a Bluetooth interface).
AI	Analog input; interface for analog input signals
AO	Analog output; interface for analog output signals
Brake chopper	Conducts the surplus energy from the intermediate circuit of the drive to the brake resistor when necessary. The chopper operates when the DC link voltage exceeds a certain maximum limit. The voltage rise is typically caused by deceleration (braking) of a high inertia motor.
Brake resistor	Dissipates the drive surplus braking energy conducted by the brake chopper to heat. Essential part of the brake circuit. See chapter <i>Brake chopper</i> in the <i>Hardware manual</i> of the drive.
Control board	Circuit board in which the control program runs.
Control unit	Control board built in a housing
CBAI-01	Bipolar to unipolar voltage converter option module
CDPI-01	Communication adapter module
CCA-01	Configuration adapter
CHDI-01	Optional 115/230 V digital input extension module
CMOD-01	Optional multifunction extension module (external 24 V AC/DC and digital I/O extension)
CMOD-02	Optional multifunction extension module (external 24 V AC/DC and isolated PTC interface)
CPTC-02	Optional multifunction extension module (external 24 V and ATEX certified PTC interface)
DC link	DC circuit between rectifier and inverter
DC link capacitors	Energy storage which stabilizes the intermediate circuit DC voltage
DI	Digital input; interface for digital input signals
DO	Digital output; interface for digital output signals
DPMP-01	Mounting platform for ACX-AP control panel (flange mounting)
DPMP-02/03	Mounting platform for ACX-AP control panel (surface mounting)
Drive	Frequency converter for controlling AC motors
EFB	Embedded fieldbus
FBA	Fieldbus adapter
FCAN-01	Optional CANopen adapter module
FCNA-01	ControlNet adapter module
FDNA-01	Optional DeviceNet adapter module

Term/abbreviation	Explanation
FECA-01	Optional EtherCAT adapter module
FENA-21	Optional Ethernet adapter module for EtherNet/IP, Modbus/TCP and PROFINET IO protocols
FEIP-21	Optional EtherNet/IP adapter module
FEPL-02	Ethernet POWERLINK adapter module
FMBT-21	Optional Modbus/TCP adapter module
FPBA-01	Optional PROFIBUS DP adapter module
FPNO-21	Optional PROFINET IO adapter module
Frame (size)	Refers to drive physical size, for example R1 and R2. The type designation label attached to the drive shows the frame of the drive, see chapter <i>Operation principle and hardware description</i> , section <i>Type designation label</i> in the <i>Hardware manual</i> of the drive.
FSCA-01	Optional RSA-485 adapter module (Modbus/RTU)
ID run	Motor identification run. During the identification run, the drive will identify the characteristics of the motor for optimum motor control.
IGBT	Insulated gate bipolar transistor
Intermediate circuit	See <a href="#">DC link</a> .
Inverter	Converts direct current and voltage to alternating current and voltage.
I/O	Input/Output
LSW	Least significant word
Macro	Pre-defined default values of parameters in drive control program. Each macro is intended for a specific application. See chapter <a href="#">Control macros</a> on page 77.
NETA-21	Remote monitoring tool
Network control	With fieldbus protocols based on the Common Industrial Protocol (CIP™), such as DeviceNet and Ethernet/IP, denotes the control of the drive using the Net Ctrl and Net Ref objects of the ODVA AC/DC Drive Profile. For more information, see <a href="http://www.odva.org">www.odva.org</a> , and the following manuals: <ul style="list-style-type: none"> <li>• <i>FDNA-01 DeviceNet adapter module user's manual</i> (3AFE68573360 [English]), and</li> <li>• <i>FENA-01/-11/-21 Ethernet adapter module user's manual</i> (3AUA0000093568 [English]).</li> </ul>
Parameter	User-adjustable operation instruction to the drive, or signal measured or calculated by the drive
PID controller	Proportional–integral–derivative controller. Drive speed control is based on PID algorithm.
PLC	Programmable logic controller
PROFIBUS, PROFIBUS DP, PROFINET IO	Registered trademarks of PI - PROFIBUS & PROFINET International

Term/abbreviation	Explanation
PTC	Positive temperature coefficient, thermistor whose resistance is dependent on temperature,
R1, R2, ...	<i>Frame (size)</i>
RO	Relay output; interface for a digital output signal. Implemented with a relay.
Rectifier	Converts alternating current and voltage to direct current and voltage.
STO	Safe torque off. See chapter <i>The Safe torque off function</i> in the <i>Hardware manual</i> of the drive.

## Cybersecurity disclaimer

This product is designed to be connected to and to communicate information and data via a network interface. It is Customer's sole responsibility to provide and continuously ensure a secure connection between the product and Customer network or any other network (as the case may be). Customer shall establish and maintain any appropriate measures (such as but not limited to the installation of firewalls, application of authentication measures, encryption of data, installation of anti-virus programs, etc) to protect the product, the network, its system and the interface against any kind of security breaches, unauthorized access, interference, intrusion, leakage and/or theft of data or information. ABB and its affiliates are not liable for damages and/or losses related to such security breaches, any unauthorized access, interference, intrusion, leakage and/or theft of data or information.

See also section [User lock](#) on page 192.

---

# 2

## Start-up, control with I/O and ID run

---

### Contents of this chapter











The chapter describes how to:

- perform the start-up
- start, stop, change the direction of the motor rotation and adjust the speed of the motor through the I/O interface
- perform an Identification run (ID run) for the drive.













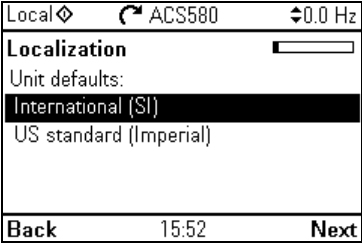

## How to start up the drive

- **How to start up the drive using the First start assistant on the assistant control panel**

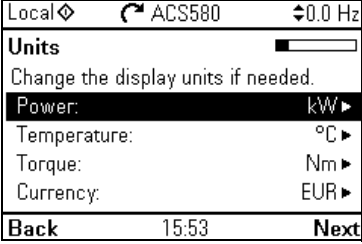
Safety	
	<p>Do not start-up the drive unless you are a qualified electrician.</p> <p>Read and obey the instructions in chapter <i>Safety instructions</i> at the beginning of the <i>Hardware manual</i> of the drive. Ignoring the instructions can cause physical injury or death, or damage to the equipment</p>
<input type="checkbox"/>	<p>Check the installation. See chapter <i>Installation checklist</i> in the <i>Hardware manual</i> of the drive.</p>
<input type="checkbox"/>	<p style="text-align: center;"></p> <p>Make sure there is no active start on (DI1 in factory settings, that is, ABB standard macro). The drive will start up automatically at power-up if the external run command is on and the drive is in the remote control mode.</p> <p>Check that the starting of the motor does not cause any danger.</p> <p><b>De-couple the driven machine</b> if</p> <ul style="list-style-type: none"> <li>• there is a risk of damage in case of an incorrect direction of rotation, or</li> <li>• a <b>Normal</b> ID run is required during the drive start-up, when the load torque is higher than 20% or the machinery is not able to withstand the nominal torque transient during the ID run.</li> </ul>
Hints on using the assistant control panel	
<p>The two commands at the bottom of the display (<b>Options</b> and <b>Menu</b> in the figure on the right), show the functions of the two softkeys  and  located below the display. The commands assigned to the softkeys vary depending on the context.</p> <p>Use keys , ,  and  to move the cursor and/or change values depending on the active view.</p> <p>Key  shows a context-sensitive help page.</p> <p>For more information, see <i>ACx-AP-x assistant control panels user's manual</i> (3AUA0000085685 [English]).</p>	
1 – First start assistant guided settings: Language, date and time, and motor nominal values	
<input type="checkbox"/>	<p>Have the motor name plate data at hand.</p> <p>Power up the drive.</p>

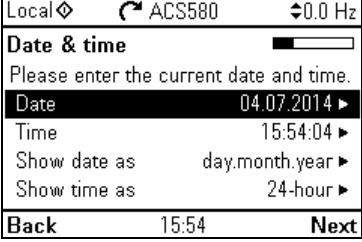

<p><input type="checkbox"/> The First start assistant guides you through the first start-up.</p> <p>The assistant begins automatically. Wait until the control panel enters the view shown on the right.</p> <p>Select the language you want to use by highlighting it (if not already highlighted) and pressing  (<b>OK</b>).</p> <p><b>Note:</b> After you have selected the language, it takes a few minutes to download the language file to the control panel.</p>	
<p><input type="checkbox"/> Select <b>Start set-up</b> and press  (<b>Next</b>).</p>	
<p><input type="checkbox"/> Select the localization you want to use and press  (<b>Next</b>).</p>	
<p><input type="checkbox"/> Change the units shown on the panel if needed.</p> <ul style="list-style-type: none"> <li>• Go to the edit view of a selected row by pressing .</li> <li>• Scroll the view with  and .</li> </ul> <p>Go to the next view by pressing  (<b>Next</b>).</p>	
<p><input type="checkbox"/> Set the date and time as well as date and time display formats.</p> <ul style="list-style-type: none"> <li>• Go to the edit view of a selected row by pressing .</li> <li>• Scroll the view with  and .</li> </ul> <p>Go to the next view by pressing  (<b>Next</b>).</p>	

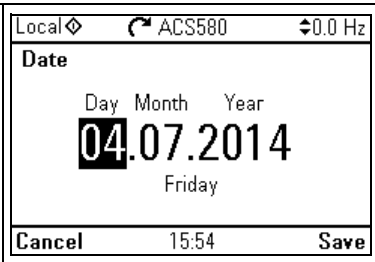
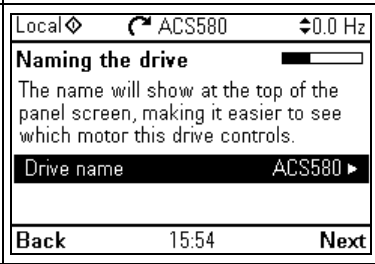
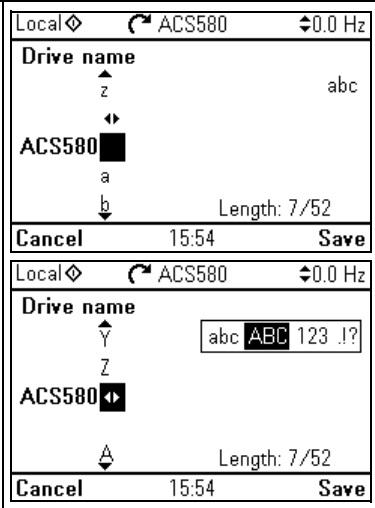

<p><input type="checkbox"/> In an edit view:</p> <ul style="list-style-type: none"> <li>• Use  and  to move the cursor left and right.</li> <li>• Use  and  to change the value.</li> <li>• Press  (<b>Save</b>) to accept the new setting, or press  (<b>Cancel</b>) to go back to the previous view without making changes.</li> </ul>	 <p>Local  ACS580 0.0 Hz</p> <p><b>Date</b></p> <p>Day Month Year</p> <p><b>04.07.2014</b></p> <p>Friday</p> <p><b>Cancel</b> 15:54 <b>Save</b></p>
<p><input type="checkbox"/> To give the drive a name that will be shown at the top, press .</p> <p>If you do not want to change the default name (ACS580), continue straight to the set-up of the motor nominal values by pressing  (<b>Next</b>).</p>	 <p>Local  ACS580 0.0 Hz</p> <p><b>Naming the drive</b></p> <p>The name will show at the top of the panel screen, making it easier to see which motor this drive controls.</p> <p>Drive name ACS580 </p> <p><b>Back</b> 15:54 <b>Next</b></p>
<p><input type="checkbox"/> Enter the name:</p> <ul style="list-style-type: none"> <li>• To select the character mode (lower case / upper case / numbers / special characters), press  until symbol  is highlighted and then select the mode with  and . Now you can start adding characters. The mode remains selected until you select another one.</li> <li>• To add a character, highlight it with  and , and press .</li> <li>• To remove a letter, press .</li> <li>• Press  (<b>Save</b>) to accept the new setting, or press  (<b>Cancel</b>) to go back to the previous view without making changes.</li> </ul>	 <p>Local  ACS580 0.0 Hz</p> <p><b>Drive name</b></p> <p>z abc</p> <p>ACS580</p> <p>a Length: 7/52</p> <p>b</p> <p><b>Cancel</b> 15:54 <b>Save</b></p> <hr/> <p>Local  ACS580 0.0 Hz</p> <p><b>Drive name</b></p> <p>Y abc ABC 123 !?</p> <p>Z ACS580</p> <p>A Length: 7/52</p> <p><b>Cancel</b> 15:54 <b>Save</b></p>





Refer to the motor nameplate for the following nominal value settings of the motor. Enter the values exactly as shown on the motor nameplate.

Example of a nameplate of an induction (asynchronous) motor:

<b>ABB Motors</b>									
3 ~ motor		M2AA 200 MLA 4							
IEC 200 M/L 55									
No.									
					Ins.cl. F		IP 55		
V	Hz	kW	r/min	A	cos φ	IA/IN	tE/s		
690 Y	50	30	1475	32.5	0.83				
400 D	50	30	1475	56	0.83				
660 Y	50	30	1470	34	0.83				
380 D	50	30	1470	59	0.83				
415 D	50	30	1475	54	0.83				
440 D	60	35	1770	59	0.83				
Cat. no 3GAA 202 001 - ADA									
6312/C3			6210/C3				180 kg		
IEC 34-1									

Select the motor type.  
 Check that the motor data is correct. Values are predefined on the basis of the drive size but you should verify that they correspond to the motor. Start with the motor nominal current.  
 If you have to change the value, go to the edit view of the selected row by pressing (when this symbol is shown at the end of the row).

Local ACS580 ↕ 0.0 Hz

**Motor nominal values**

Find the values on the motor's nameplate, and enter them here:

Type: Asynchronous motor

Current: 1.8 A

Voltage: 400.0 V

Back 15:56 Next

Set the correct value:

- Use and to move the cursor left and right.
- Use and to change the value.

Press (**Save**) to accept the new setting, or press (**Cancel**) to go back to the previous view without making changes.

Local ACS580 ↕ 0.0 Hz

**Current:**

1.8 A

▼

0.0 5.2

Cancel 15:56 Save

Continue to check/edit the nominal values and select scalar or vector control mode.  
 Motor nominal cos φ and nominal torque are optional.  
 Roll down with to see the last row in the view.  
 After editing the last row, the control panel goes to the next view.  
 To go directly to the next view, press (**Next**).

Local ACS580 ↕ 0.0 Hz

**Motor nominal values**

Find the values on the motor's nameplate, and enter them here:







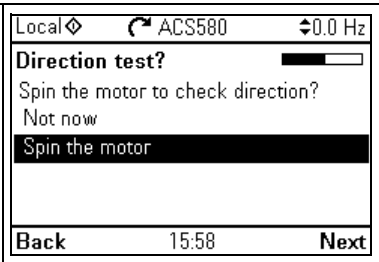

Cos φ (optional): 0.00

Torque (optional): 0.000 Nm

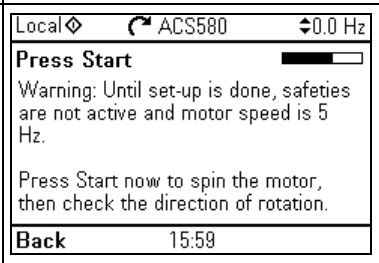

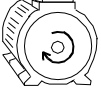

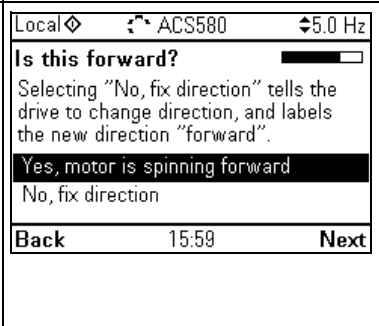

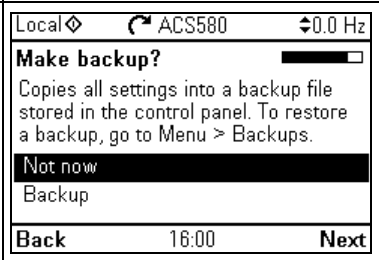

Control mode: Scalar

Back 15:58 Next





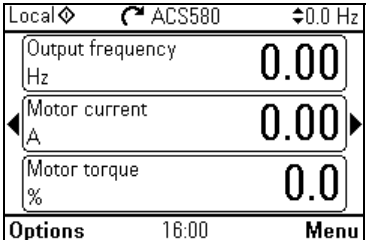









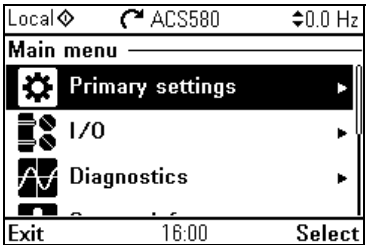

<p><input type="checkbox"/> Direction test is optional, and requires rotating the motor. Do not do this if it could cause any risk, or if the mechanical set-up does not allow it.</p> <p>To do the direction test, select <b>Spin the motor</b> and press  (<b>Next</b>).</p>	
<p><input type="checkbox"/> Press the Start key  on the control panel to start the drive.</p>	
<p><input type="checkbox"/> Check the direction of the motor.</p> <p>If it is forward, select <b>Yes, motor is spinning forward</b> and press  (<b>Next</b>) to continue.</p> <p>If the direction is not forward, select <b>No, fix direction</b> and press  (<b>Next</b>) to continue.</p> <div style="display: flex; justify-content: space-around; align-items: center;"> <div style="text-align: center;">  <p>Forward direction</p> </div> <div style="text-align: center;">  <p>Reverse direction</p> </div> </div>	
<p><input type="checkbox"/> If you want to make a backup of the settings made so far, select <b>Backup</b> and press  (<b>Next</b>).</p> <p>If you do not want to make a backup, select <b>Not now</b> and press  (<b>Next</b>).</p>	

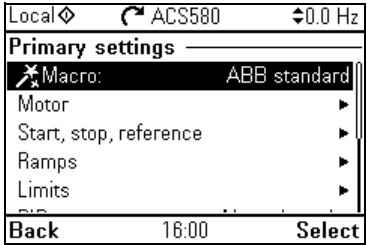

<p><input type="checkbox"/> The first start is now complete and the drive is ready for use. Press  (<b>Done</b>) to enter the Home view.</p>	 <p>Local  ACS580  0.0 Hz</p> <p><b>First start complete</b> Drive is ready for use. Start/Stop: DI1 Direction: DI2 Reference (freq): All scaled</p> <p><b>Back</b> 16:00 <b>Done</b></p>
<p><input type="checkbox"/> The Home view monitoring the values of the selected signals is shown on the control panel. There are several different Home view displays (see page 45). You can browse them with the arrow keys ( and ).</p>	 <p>Local  ACS580  0.0 Hz</p> <p>Output frequency 0.00 Hz</p> <p>Motor current 0.00 A</p> <p>Motor torque 0.0 %</p> <p><b>Options</b> 16:00 <b>Menu</b></p>

**2 – Additional settings in the Primary settings menu**

<p><input type="checkbox"/> Make any additional adjustments, for example, macro, ramps, and limits, starting from the <b>Main</b> menu – press  (<b>Menu</b>) to enter the <b>Main</b> menu. Select <b>Primary settings</b> and press  (<b>Select</b>) (or ).</p> <p>ABB recommends that you make at least these additional settings:</p> <ul style="list-style-type: none"> <li>• Choose a macro or set start, stop and reference values individually</li> <li>• Ramps</li> <li>• Limits</li> </ul> <p>With the <b>Primary settings</b> menu, you can also adjust settings related to the motor, PID, fieldbus, advanced functions and clock, region and display. In addition, the menu contains an item to reset the control panel Home view.</p> <p>To get more information on <b>Primary settings</b> menu items, press  to open the help page.</p>	 <p>Local  ACS580  0.0 Hz</p> <p><b>Main menu</b></p> <ul style="list-style-type: none"> <li> <b>Primary settings</b> ▶</li> <li> I/O ▶</li> <li> <b>Diagnostics</b> ▶</li> </ul> <p><b>Exit</b> 16:00 <b>Select</b></p>  <p>Local  ACS580  0.0 Hz</p> <p><b>Primary settings</b></p> <ul style="list-style-type: none"> <li> <b>Macro:</b> ABB standard ▶</li> <li>Motor ▶</li> <li>Start, stop, reference ▶</li> <li>Ramps ▶</li> <li>Limits ▶</li> </ul> <p><b>Back</b> 16:00 <b>Select</b></p>
---	---



**2 – Additional settings: Macro**

Select **Macro:** and press (**Select**) (or ).

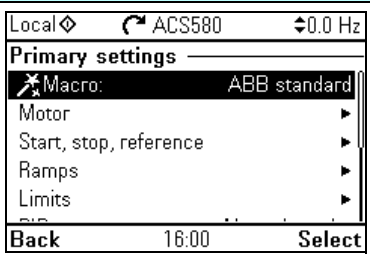

To change the macro in use, select the new macro and press (**Select**), or to go back without changes, press (**Back**).

**Notes:**

- Changing macro resets all settings except motor data to the default values of the selected macro.
- When you change the macro, you also change the use of the I/O signals in the drive. Make sure the actual I/O wiring and the use of I/O in the control program match each other. You can check the current I/O use in the **I/O** menu under the **Main** menu (see page 30).









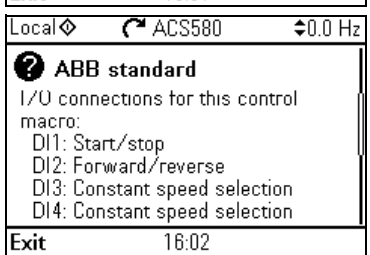
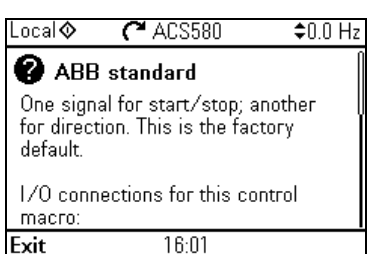



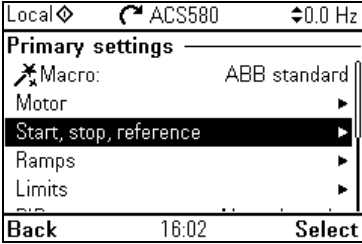



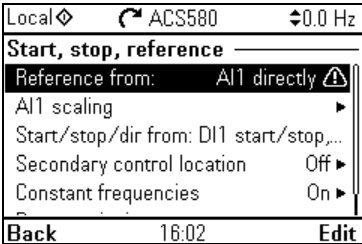

To get information on a selected macro, press . The help page shows the use of signals and I/O connections. For detailed I/O connection diagrams, see chapter *Control macros* (page 77).

Scroll the page with and .

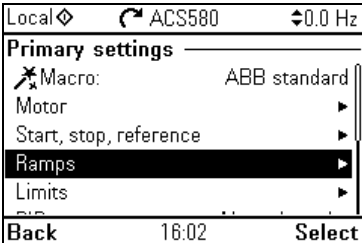
To return to the **Control macro** submenu, press (**Exit**).

- All macros, except the ABB standard (vector) macro, use scalar motor control by default. At the first start you can select to use scalar or vector motor control. If you later want to change the selection, Select **Menu - Primary settings - Motor - Control mode** and follow the instructions.

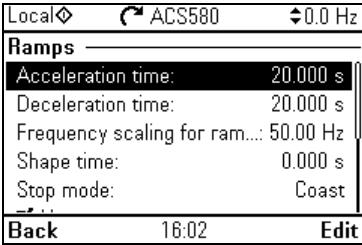

2 – Additional settings: Start, stop and reference values	
<input type="checkbox"/> If you do not wish to use a macro, define the settings for start, stop and reference: Select <b>Start, stop, reference</b> and press  ( <b>Select</b> ) (or  ).	 <p>Local  ACS580  0.0 Hz</p> <p><b>Primary settings</b></p> <ul style="list-style-type: none"> <li>Macro: ABB standard</li> <li>Motor ▶</li> <li><b>Start, stop, reference ▶</b></li> <li>Ramps ▶</li> <li>Limits ▶</li> </ul> <p>Back 16:02 Select</p>
<input type="checkbox"/> Adjust the parameters according to your needs. Select parameter and press  ( <b>Select</b> ). When you change the settings, you also change the use of the I/O signals in the drive. Make sure the actual I/O wiring and the use of I/O in the control program match each other. You can check the current I/O use in the <b>I/O</b> menu under the <b>Main</b> menu (see page 30). After making the adjustments, go back to the <b>Primary settings</b> menu by pressing  ( <b>Back</b> ).	 <p>Local  ACS580  0.0 Hz</p> <p><b>Start, stop, reference</b></p> <ul style="list-style-type: none"> <li><b>Reference from: AI1 directly </b></li> <li>AI1 scaling ▶</li> <li>Start/stop/dir from: DI1 start/stop,...</li> <li>Secondary control location Off ▶</li> <li>Constant frequencies On ▶</li> </ul> <p>Back 16:02 Edit</p>
2 – Additional settings: Ramps (acceleration and deceleration times for the motor)	
<input type="checkbox"/> Select <b>Ramps</b> and press  ( <b>Select</b> ) (or  ).	 <p>Local  ACS580  0.0 Hz</p> <p><b>Primary settings</b></p> <ul style="list-style-type: none"> <li>Macro: ABB standard</li> <li>Motor ▶</li> <li>Start, stop, reference ▶</li> <li><b>Ramps ▶</b></li> <li>Limits ▶</li> </ul> <p>Back 16:02 Select</p>
<input type="checkbox"/> Adjust the parameters according to your needs. Select a parameter and press  ( <b>Edit</b> ). After making the adjustments, go back to the <b>Primary settings</b> menu by pressing  ( <b>Back</b> ).	 <p>Local  ACS580  0.0 Hz</p> <p><b>Ramps</b></p> <ul style="list-style-type: none"> <li><b>Acceleration time: 20.000 s</b></li> <li>Deceleration time: 20.000 s</li> <li>Frequency scaling for ram... 50.00 Hz</li> <li>Shape time: 0.000 s</li> <li>Stop mode: Coast</li> </ul> <p>Back 16:02 Edit</p>











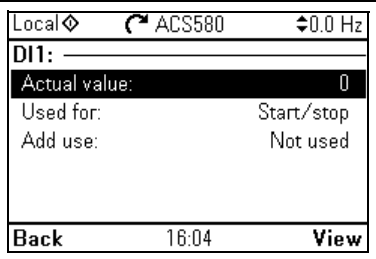









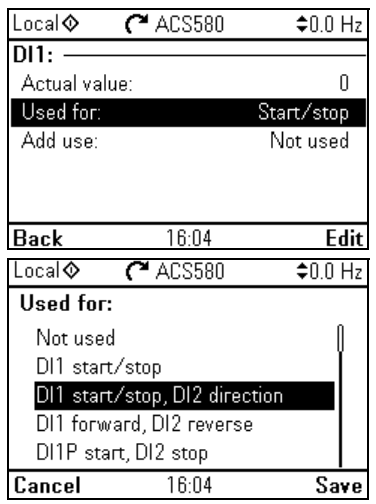





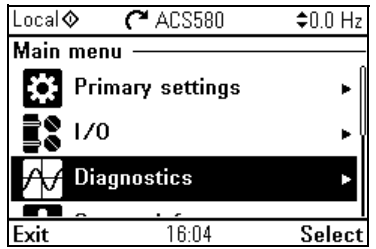

## 2 – Additional settings: Limits

<input type="checkbox"/> Select <b>Limits</b> and press  ( <b>Select</b> ) (or ).	<div style="border: 1px solid black; padding: 2px;"> <div style="display: flex; justify-content: space-between; border-bottom: 1px solid black;"> <span>Local </span> <span>ACS580</span> <span>0.0 Hz</span> </div> <div style="border-bottom: 1px solid black; padding: 2px;"> <b>Primary settings</b> <ul style="list-style-type: none"> <li>Macro: ABB standard</li> <li>Motor <span style="float: right;">▶</span></li> <li>Start, stop, reference <span style="float: right;">▶</span></li> <li>Ramps <span style="float: right;">▶</span></li> <li><b>Limits</b> <span style="float: right;">▶</span></li> </ul> </div> <div style="display: flex; justify-content: space-between; border-top: 1px solid black; border-bottom: 1px solid black;"> <span>Back</span> <span>16:02</span> <span>Select</span> </div> </div>
<input type="checkbox"/> Adjust the parameters according to your needs. Select a parameter and press  ( <b>Select</b> ). After making the adjustments, go back to the <b>Primary settings</b> menu by pressing  ( <b>Back</b> ).	<div style="border: 1px solid black; padding: 2px;"> <div style="display: flex; justify-content: space-between; border-bottom: 1px solid black;"> <span>Local </span> <span>ACS580</span> <span>0.0 Hz</span> </div> <div style="border-bottom: 1px solid black; padding: 2px;"> <b>Limits</b> <ul style="list-style-type: none"> <li><b>Minimum frequency:</b> -50.00 Hz</li> <li>Maximum frequency: 50.00 Hz</li> <li>Maximum current: 3.24 A</li> </ul> </div> <div style="display: flex; justify-content: space-between; border-top: 1px solid black; border-bottom: 1px solid black;"> <span>Back</span> <span>16:03</span> <span>Edit</span> </div> </div>



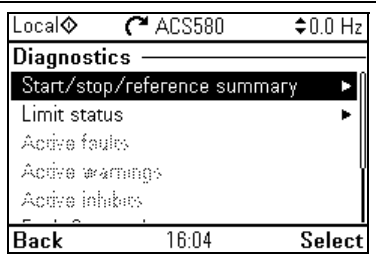







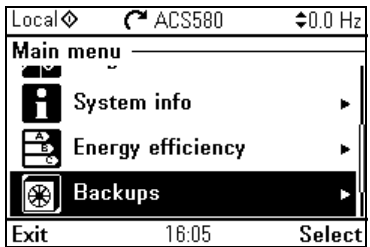

## 3 – I/O menu

<input type="checkbox"/> After the additional adjustments, make sure that the actual I/O wiring matches the I/O use in the control program. In the <b>Main</b> menu, select a <b>I/O</b> and press  ( <b>Select</b> ) to enter the <b>I/O</b> menu.	<div style="border: 1px solid black; padding: 2px;"> <div style="display: flex; justify-content: space-between; border-bottom: 1px solid black;"> <span>Local </span> <span>ACS580</span> <span>0.0 Hz</span> </div> <div style="border-bottom: 1px solid black; padding: 2px;"> <b>Main menu</b> <ul style="list-style-type: none"> <li> <b>Primary settings</b> <span style="float: right;">▶</span></li> <li> <b>I/O</b> <span style="float: right;">▶</span></li> <li> <b>Diagnostics</b> <span style="float: right;">▶</span></li> </ul> </div> <div style="display: flex; justify-content: space-between; border-top: 1px solid black; border-bottom: 1px solid black;"> <span>Exit</span> <span>16:03</span> <span>Select</span> </div> </div>
<input type="checkbox"/> Select a the connection you want to check and press  ( <b>Select</b> ) (or ).	<div style="border: 1px solid black; padding: 2px;"> <div style="display: flex; justify-content: space-between; border-bottom: 1px solid black;"> <span>Local </span> <span>ACS580</span> <span>0.0 Hz</span> </div> <div style="border-bottom: 1px solid black; padding: 2px;"> <b>I/O</b> <ul style="list-style-type: none"> <li><b>DI1: 0</b> Start/stop <span style="float: right;">▶</span></li> <li>DI2: <b>1</b> Direction <span style="float: right;">▶</span></li> <li>DI3: <b>0</b> Used in several places <span style="float: right;">▶</span></li> <li>DI4: <b>0</b> Used in several places <span style="float: right;">▶</span></li> <li>DI5: <b>0</b> Switch to ramp set 2 <span style="float: right;">▶</span></li> </ul> </div> <div style="display: flex; justify-content: space-between; border-top: 1px solid black; border-bottom: 1px solid black;"> <span>Back</span> <span>16:03</span> <span>Select</span> </div> </div>

<p><input type="checkbox"/> To view the details of a parameter that cannot be adjusted via the I/O menu, press  (<b>View</b>).</p>	 <p>Local  ACS580  0.0 Hz</p> <p>DI1: —</p> <p>Actual value: 0</p> <p>Used for: Start/stop</p> <p>Add use: Not used</p> <hr/> <p>Back 16:04 View</p>
<p><input type="checkbox"/> To adjust the value of a parameter, press  (<b>Edit</b>), adjust the value using , ,  and  keys and press  (<b>Save</b>). Note that the actual wiring must match the new value.</p> <p>Go back to the <b>Main</b> menu by pressing  (<b>Back</b>) repeatedly.</p>	 <p>Local  ACS580  0.0 Hz</p> <p>DI1: —</p> <p>Actual value: 0</p> <p>Used for: Start/stop</p> <p>Add use: Not used</p> <hr/> <p>Back 16:04 Edit</p> <p>Local  ACS580  0.0 Hz</p> <p>Used for:</p> <p>Not used</p> <p>DI1 start/stop</p> <p>DI1 start/stop, DI2 direction</p> <p>DI1 forward, DI2 reverse</p> <p>DI1P start, DI2 stop</p> <hr/> <p>Cancel 16:04 Save</p>
<h4 style="background-color: #e0f0ff; padding: 5px;">4 – Diagnostics menu</h4>	
<p><input type="checkbox"/> After making the additional adjustments and checking the I/O connections, use the <b>Diagnostics</b> menu to make sure that the setup is functioning correctly.</p> <p>In the <b>Main</b> menu, select <b>Diagnostics</b> and press  (<b>Select</b>) (or ).</p>	 <p>Local  ACS580  0.0 Hz</p> <p>Main menu —</p> <p> Primary settings ▶</p> <p> I/O ▶</p> <p> <b>Diagnostics</b> ▶</p> <hr/> <p>Exit 16:04 Select</p>
<p><input type="checkbox"/> Select the diagnostics item you want to view and press  (<b>Select</b>).</p> <p>Return to the <b>Diagnostics</b> menu by pressing  (<b>Back</b>).</p>	 <p>Local  ACS580  0.0 Hz</p> <p>Diagnostics —</p> <p>Start/stop/reference summary ▶</p> <p>Limit status ▶</p> <p>Active faults</p> <p>Active warnings</p> <p>Active inhibits</p> <hr/> <p>Back 16:04 Select</p>

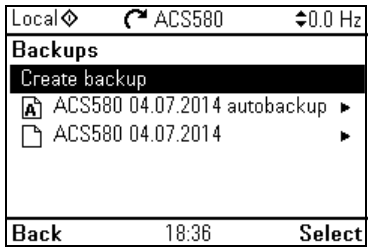

## 5 – Backup

<input type="checkbox"/> After you have finished start-up, ABB recommends that you make a backup. In the <b>Main</b> menu, select <b>Backups</b> and press  ( <b>Select</b> ) (or  ).	 <p>Local  ACS580  0.0 Hz</p> <p><b>Main menu</b></p> <ul style="list-style-type: none"> <li> System info ▶</li> <li> Energy efficiency ▶</li> <li> <b>Backups</b> ▶</li> </ul> <p>Exit 16:05 <b>Select</b></p>
<input type="checkbox"/> Press  ( <b>Select</b> ) to start backup.	 <p>Local  ACS580  0.0 Hz</p> <p><b>Backups</b></p> <ul style="list-style-type: none"> <li><b>Create backup</b></li> <li> ACS580 04.07.2014 autobackup ▶</li> <li> ACS580 04.07.2014 ▶</li> </ul> <p>Back 18:36 <b>Select</b></p>





## How to control the drive through the I/O interface

The table below describes how to operate the drive through the digital and analog inputs when:

- the motor start-up is performed, and
- the default parameter settings of the ABB standard macro are in use.

Preliminary settings																
<p>If you need to change the direction of rotation, check that limits allow reverse direction: Go to <b>Menu - Primary settings - Limits</b> and make sure that the minimum limit has a negative value and the maximum limit has a positive value.</p> <p>Make sure that the control connections are wired according to the connection diagram given for the ABB standard macro.</p> <p>Make sure that the drive is in remote control. Press key <b>Loc/Rem</b> to switch between remote and local control.</p>	<p>See section <a href="#">ABB standard macro</a> on page 78.</p> <p>In remote control, the control panel display shows text <b>Remote</b> at the top left.</p>															
Starting and controlling the speed of the motor																
<p>Start by switching digital input DI1 on.</p> <p>The arrow starts rotating. It is dotted until the setpoint is reached.</p> <p>Regulate the drive output frequency (motor speed) by adjusting voltage of analog input AI1.</p>	<table border="1" style="width: 100%; border-collapse: collapse;"> <tr> <td style="font-size: small;">Remote</td> <td style="font-size: small;">ACS580</td> <td style="font-size: small;">20.2 Hz</td> </tr> <tr> <td style="font-size: small;">Output frequency</td> <td style="font-size: x-large; text-align: center;">14.20</td> <td style="font-size: small;">Hz</td> </tr> <tr> <td style="font-size: small;">Motor current</td> <td style="font-size: x-large; text-align: center;">0.39</td> <td style="font-size: small;">A</td> </tr> <tr> <td style="font-size: small;">Motor torque %</td> <td style="font-size: x-large; text-align: center;">1.4</td> <td style="font-size: small;">%</td> </tr> <tr> <td style="font-size: small;">Options</td> <td style="font-size: small;">13:51</td> <td style="font-size: small;">Menu</td> </tr> </table>	Remote	ACS580	20.2 Hz	Output frequency	14.20	Hz	Motor current	0.39	A	Motor torque %	1.4	%	Options	13:51	Menu
Remote	ACS580	20.2 Hz														
Output frequency	14.20	Hz														
Motor current	0.39	A														
Motor torque %	1.4	%														
Options	13:51	Menu														
Changing the direction of the motor rotation																
<p>Reverse direction: Switch digital input DI2 on.</p> <p>Forward direction: Switch digital input DI2 off.</p>	<table border="1" style="width: 100%; border-collapse: collapse;"> <tr> <td style="font-size: small;">Remote</td> <td style="font-size: small;">ACS580</td> <td style="font-size: small;">-20.3 Hz</td> </tr> <tr> <td style="font-size: small;">Output frequency</td> <td style="font-size: x-large; text-align: center;">-14.90</td> <td style="font-size: small;">Hz</td> </tr> <tr> <td style="font-size: small;">Motor current</td> <td style="font-size: x-large; text-align: center;">0.39</td> <td style="font-size: small;">A</td> </tr> <tr> <td style="font-size: small;">Motor torque %</td> <td style="font-size: x-large; text-align: center;">-0.9</td> <td style="font-size: small;">%</td> </tr> <tr> <td style="font-size: small;">Options</td> <td style="font-size: small;">14:03</td> <td style="font-size: small;">Menu</td> </tr> </table>	Remote	ACS580	-20.3 Hz	Output frequency	-14.90	Hz	Motor current	0.39	A	Motor torque %	-0.9	%	Options	14:03	Menu
Remote	ACS580	-20.3 Hz														
Output frequency	-14.90	Hz														
Motor current	0.39	A														
Motor torque %	-0.9	%														
Options	14:03	Menu														



**Stopping the motor**

Switch digital input DI1 off. The arrow stops rotating.

Remote	↶ ACS580	-20.3 Hz
Output frequency		<b>0.00</b>
Hz		
Motor current		<b>0.00</b>
A		
Motor torque %		<b>0.0</b>
%		
<b>Options</b>	13:52	<b>Menu</b>



## How to perform the ID run

The drive automatically estimates motor characteristics using *Standstill* ID run when the drive is started for the first time in vector control and after any motor parameter (group [99 Motor data](#)) is changed. This is valid when

- parameter [99.13 ID run requested](#) selection is *Standstill* and
- parameter [99.04 Motor control mode](#) selection is *Vector*.

In most applications there is no need to perform a separate ID run. The ID run should be selected manually if:

- vector control mode is used (parameter [99.04 Motor control mode](#) is set to *Vector*), and
- permanent magnet motor (PM) is used (parameter [99.03 Motor type](#) is set to *Permanent magnet motor*), or
- synchronous reluctance motor (SynRM) is used (parameter [99.03 Motor type](#) is set to *SynRM*), or
- drive operates near zero speed references, or
- operation at torque range above the motor nominal torque, over a wide speed range is needed.

Do the ID run with the ID run assistant by selecting **Menu - Primary settings - Motor - ID run** (see page [36](#)) or with parameter [99.13 ID run requested](#) (see page [38](#)).

**Note:** If motor parameters (group [99 Motor data](#)) are changed after the ID run, it must be repeated.

**Note:** If you have already parameterized your application using the scalar motor control mode ([99.04 Motor control mode](#) is set to *Scalar*) and you need to change motor control mode to *Vector*,

- change the control mode to vector with the **Control mode** assistant (go to **Menu - Primary settings - Motor - Control mode**) and follow the instructions. The ID run assistant then guides you through the ID run.











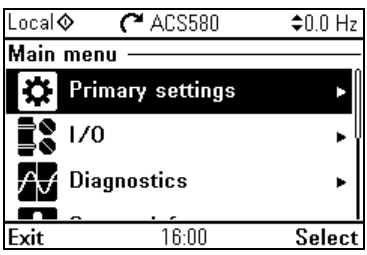

or

- set parameter [99.04 Motor control mode](#) to *Vector*, and
  - for I/O controlled drive, check parameters in groups [22 Speed reference selection](#), [23 Speed reference ramp](#), [12 Standard AI](#), [30 Limits](#) and [46 Monitoring/scaling settings](#).
  - for torque controlled drive, check also parameters in group [26 Torque reference chain](#).





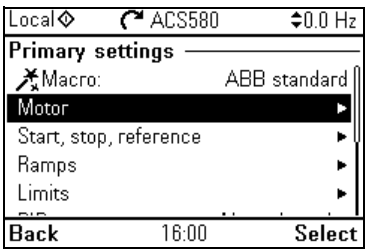







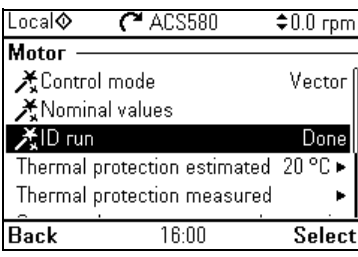







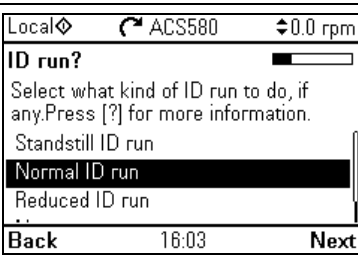

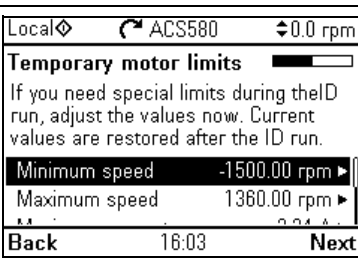

## ■ ID run procedure

### With the ID run assistant

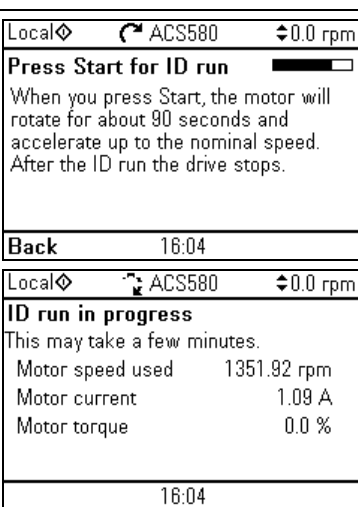

Pre-check	
	<p><b>WARNING!</b> The motor will run at up to approximately 50...80% of the nominal speed during the ID run. The motor will rotate in the forward direction. <b>Make sure that it is safe to run the motor before performing the ID run.</b></p> <p><b>Do not do ID run on a rotating motor. Make sure that the motor is stopped before starting the ID run.</b></p>
<input type="checkbox"/> De-couple the motor from the driven equipment <input type="checkbox"/> Check that the values of the motor data parameters are equivalent to those on the motor nameplate. <input type="checkbox"/> Check that the STO circuit is closed. <p>The assistant will ask if you want to use temporary motor limits. They must meet the following conditions:</p> <input type="checkbox"/> Minimum speed $\leq 0$ rpm <input type="checkbox"/> Maximum speed = motor rated speed (Normal ID run procedure needs the motor to be run at 100% speed.) <input type="checkbox"/> Maximum current $> I_{HD}$ <input type="checkbox"/> Maximum torque $> 50\%$ <input type="checkbox"/> Make sure that the control panel is in local control (text Local shown at the top left). Press key <b>Loc/Rem</b> to switch between local and remote control.	
ID run	
<input type="checkbox"/> Go to the <b>Main</b> menu by pressing  ( <b>Menu</b> ) in the Home view. Select <b>Primary settings</b> and press  ( <b>Select</b> ) (or  ).	 <p>Local  ACS580 <math>\pm 0.0</math> Hz  <b>Main menu</b>   <b>Primary settings</b> ▶   I/O ▶   Diagnostics ▶                  Exit 16:00 <b>Select</b></p>
<input type="checkbox"/> Select <b>Motor</b> and press  ( <b>Select</b> ) (or  ).	 <p>Local  ACS580 <math>\pm 0.0</math> Hz  <b>Primary settings</b>   Macro: ABB standard  <b>Motor</b>                  Start, stop, reference ▶                  Ramps ▶                  Limits ▶                  Back 16:00 <b>Select</b></p>









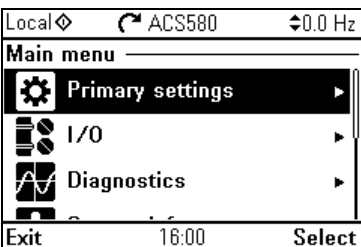



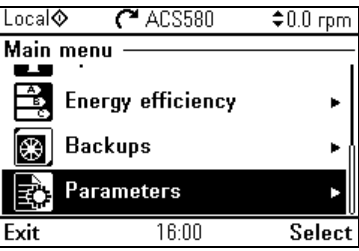







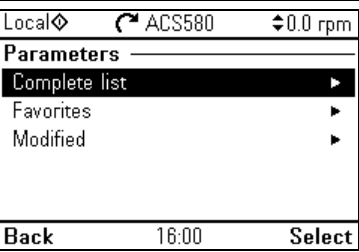





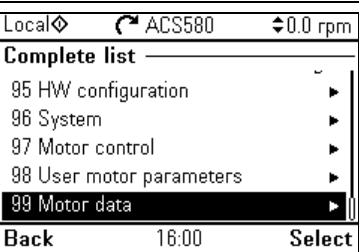



<input type="checkbox"/>	<p>Select <b>ID run</b> (shown only when the drive is in vector control mode) and press  (<b>Select</b>) (or ).</p>	 <p>Local  ACS580  0.0 rpm</p> <p><b>Motor</b></p> <ul style="list-style-type: none"> <li> Control mode Vector</li> <li> Nominal values</li> <li> ID run Done</li> <li>Thermal protection estimated 20 °C ▶</li> <li>Thermal protection measured ▶</li> </ul> <p><b>Back</b> 16:00 <b>Select</b></p>
<input type="checkbox"/>	<p>Select the type of ID run you want to do and press  (<b>Select</b>) (or ).</p>	 <p>Local  ACS580  0.0 rpm</p> <p><b>ID run?</b></p> <p>Select what kind of ID run to do, if any. Press [?] for more information.</p> <ul style="list-style-type: none"> <li>Standstill ID run</li> <li><b>Normal ID run</b></li> <li>Reduced ID run</li> </ul> <p><b>Back</b> 16:03 <b>Next</b></p>
<input type="checkbox"/>	<p>Warning message <b>Identification run</b> is shown at the top for a few seconds.</p> <p>Control panel LED starts blinking green to indicate an active warning.</p> <p>Check the motor limits shown on the control panel. If you need other limits during the ID run you can enter them here. The originals limits will be restored after the ID run.</p> <p>Press  (<b>Next</b>).</p>	 <p>Local  ACS580  0.0 rpm</p> <p><b>Temporary motor limits</b></p> <p>If you need special limits during the ID run, adjust the values now. Current values are restored after the ID run.</p> <ul style="list-style-type: none"> <li><b>Minimum speed</b> -1500.00 rpm ▶</li> <li>Maximum speed 1360.00 rpm ▶</li> </ul> <p><b>Back</b> 16:03 <b>Next</b></p>
<input type="checkbox"/>	<p>Press the start key () to start the ID run.</p> <p>In general, ABB recommends not to press any control panel keys during the ID run. However, you can stop the ID run at any time by pressing the stop key ().</p> <p>During the ID run a progress view is shown.</p> <p>After the ID run is completed, text <b>ID run done</b> is shown. The LED stops blinking.</p> <p>If the ID run fails, fault <b>FF61 ID run</b> is shown. See chapter <a href="#">Fault tracing</a> on page 479 for more information.</p>	 <p>Local  ACS580  0.0 rpm</p> <p><b>Press Start for ID run</b></p> <p>When you press Start, the motor will rotate for about 90 seconds and accelerate up to the nominal speed. After the ID run the drive stops.</p> <p><b>Back</b> 16:04</p> <hr/> <p>Local  ACS580  0.0 rpm</p> <p><b>ID run in progress</b></p> <p>This may take a few minutes.</p> <ul style="list-style-type: none"> <li>Motor speed used 1351.92 rpm</li> <li>Motor current 1.09 A</li> <li>Motor torque 0.0 %</li> </ul> <p>16:04</p>

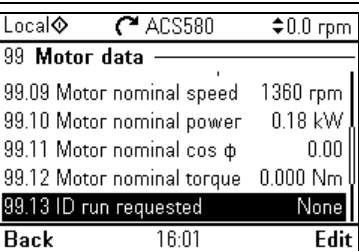

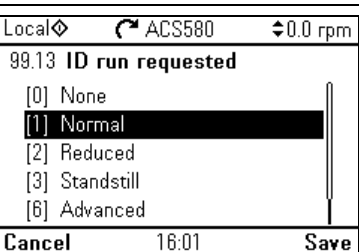

**With parameter 99.13 ID run requested**



Pre-check	
	<p><b>WARNING!</b> The motor will run at up to approximately 50...80% of the nominal speed during the ID run. The motor will rotate in the forward direction. <b>Make sure that it is safe to run the motor before performing the ID run.</b></p> <p><b>Do not do ID run on a rotating motor. Make sure that the motor is stopped before starting the ID run.</b></p>
<div style="border: 1px solid black; width: 20px; height: 20px; margin: 0 auto 20px auto; display: flex; align-items: center; justify-content: center;"> <span style="font-size: 12px; font-weight: bold;">I</span> </div> <ul style="list-style-type: none"> <li><input type="checkbox"/> De-couple the motor from the driven equipment</li> <li><input type="checkbox"/> Check that the values of the motor data parameters are equivalent to those on the motor nameplate.</li> <li><input type="checkbox"/> Check that the STO circuit is closed.</li> </ul> <p>If parameter values (from group <i>10 Standard DI, RO</i> to group <i>99 Motor data</i>) are changed before the ID run, check that the new settings meet the following conditions:</p> <ul style="list-style-type: none"> <li><input type="checkbox"/> <i>30.11 Minimum speed</i> ≤ 0 rpm</li> <li><input type="checkbox"/> <i>30.12 Maximum speed</i> = motor rated speed (Normal ID run procedure needs the motor to be run at 100% speed.)</li> <li><input type="checkbox"/> <i>30.17 Maximum current</i> &gt; <math>I_{HD}</math></li> <li><input type="checkbox"/> <i>30.20 Maximum torque 1</i> &gt; 50% or <i>30.24 Maximum torque 2</i> &gt; 50%, depending on which torque limit set is in use according to parameter <i>30.18 Torq lim sel</i>.</li> </ul> <p>Check that signals</p> <ul style="list-style-type: none"> <li><input type="checkbox"/> run enable (parameter <i>20.12 Run enable 1 source</i>) is active</li> <li><input type="checkbox"/> start enable (parameter <i>20.19 Enable start command</i>) is active</li> <li><input type="checkbox"/> enable to rotate (parameter <i>20.22 Enable to rotate</i>) is active.</li> </ul> <ul style="list-style-type: none"> <li><input type="checkbox"/> Make sure that the control panel is in local control (text Local shown at the top left). Press key <span style="border: 1px solid black; padding: 2px;">Loc/Rem</span> to switch between local and remote control.</li> </ul>	
ID run	
<ul style="list-style-type: none"> <li><input type="checkbox"/> Go to the <b>Main</b> menu by pressing  (<b>Menu</b>) in the Home view. Press .</li> </ul>	

<input type="checkbox"/>	Select <b>Parameters</b> and press  ( <b>Select</b> ) (or  ).	 <p>Local  ACS580  0.0 rpm</p> <p><b>Main menu</b></p> <ul style="list-style-type: none"> <li> Energy efficiency ▶</li> <li> Backups ▶</li> <li> <b>Parameters</b> ▶</li> </ul> <p>Exit 16:00 <b>Select</b></p>
<input type="checkbox"/>	Select <b>Complete list</b> and press  ( <b>Select</b> ) (or  ).	 <p>Local  ACS580  0.0 rpm</p> <p><b>Parameters</b></p> <ul style="list-style-type: none"> <li><b>Complete list</b> ▶</li> <li>Favorites ▶</li> <li>Modified ▶</li> </ul> <p><b>Back</b> 16:00 <b>Select</b></p>
<input type="checkbox"/>	Scroll the page with  and  , and select parameter group <b>99 Motor data</b> and press  ( <b>Select</b> ) (or  ).	 <p>Local  ACS580  0.0 rpm</p> <p><b>Complete list</b></p> <ul style="list-style-type: none"> <li>95 HW configuration ▶</li> <li>96 System ▶</li> <li>97 Motor control ▶</li> <li>98 User motor parameters ▶</li> <li><b>99 Motor data</b> ▶</li> </ul> <p><b>Back</b> 16:00 <b>Select</b></p>
<input type="checkbox"/>	Scroll the page with  and  , and select parameter <b>99.13 ID run requested</b> ( <i>99.13 ID run requested</i> ) and press  ( <b>Select</b> ) (or  ).	 <p>Local  ACS580  0.0 rpm</p> <p><b>99 Motor data</b></p> <ul style="list-style-type: none"> <li>99.09 Motor nominal speed 1360 rpm</li> <li>99.10 Motor nominal power 0.18 kW</li> <li>99.11 Motor nominal cos φ 0.00</li> <li>99.12 Motor nominal torque 0.000 Nm</li> <li><b>99.13 ID run requested</b> None</li> </ul> <p><b>Back</b> 16:01 <b>Edit</b></p>
<input type="checkbox"/>	Select the ID run type and press  ( <b>Save</b> ) (or  ).	 <p>Local  ACS580  0.0 rpm</p> <p><b>99.13 ID run requested</b></p> <ul style="list-style-type: none"> <li>[0] None</li> <li><b>[1] Normal</b></li> <li>[2] Reduced</li> <li>[3] Standstill</li> <li>[6] Advanced</li> </ul> <p><b>Cancel</b> 16:01 <b>Save</b></p>



- The control panel returns to the previous view and warning message **Identification run** is shown at the top for a few seconds. Control panel LED starts blinking green to indicate an active warning ([AFF6](#)).

The [AFF6](#) warning view is shown when no key has been pressed for one minute. Pressing  (**How to fix**) shows text informing that the ID run will be done at the next start. You can hide the warning view by pressing  (**Hide**).

Press the start key () to start the ID run. In general, ABB recommends not to press any control panel keys during the ID run. However, you can stop the ID run at any time by pressing the stop key (.
  
- During the ID run the arrow is rotating at the top. After the ID run is completed, text **ID run done** is shown. The LED stops blinking. If the ID run fails, fault [FF61 ID run](#) is shown. See chapter [Fault tracing](#) on page 479 for more information.

⚠ Identification run		
99 <b>Motor data</b>		
99.09 Motor nominal speed	1360 rpm	
99.10 Motor nominal power	0.18 kW	
99.11 Motor nominal cos φ	0.00	
99.12 Motor nominal torque	0.000 Nm	
99.13 ID run requested	Normal	
<b>Back</b>	16:02	<b>Edit</b>
Local ⬠	↻ ACS580	↕ 0.0 rpm
⚠ Warning AFF6		
Aux code: 0000 0000		
<b>Identification run</b>	16:01:53	
Motor identification run about to be performed		
<b>Hide</b>	16:02	<b>How to fix</b>
Local ⬠ ↻ ACS580 ↕ 0.0 rpm		
99 <b>Motor data</b>		
99.09 Motor nominal speed	1360 rpm	
99.10 Motor nominal power	0.18 kW	
99.11 Motor nominal cos φ	0.00	
99.12 Motor nominal torque	0.000 Nm	
99.13 ID run requested	Normal	
<b>Back</b>	16:03	<b>Edit</b>





## 3

# Control panel

---

## Contents of this chapter

This chapter contains instructions for removing and reinstalling the assistant control panel and briefly describes its display, keys and key shortcuts. For more information, see *ACx-AP-x assistant control panels user's manual* (3AUA0000085685 [English]).

## Removing and reinstalling the control panel

To remove the control panel, press the retaining clip at the top (1a) and pull it forward from the top edge (1b).

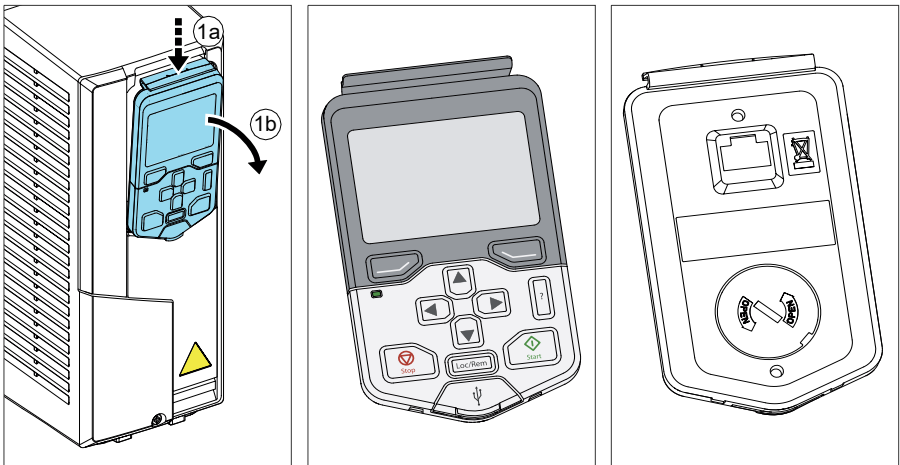

To reinstall the control panel, put the bottom of the container in position (1a), press the retaining clip at the top (1b) and push the control panel in at the top edge (1c).

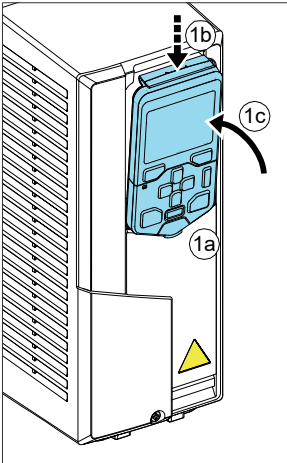

## Layout of the control panel

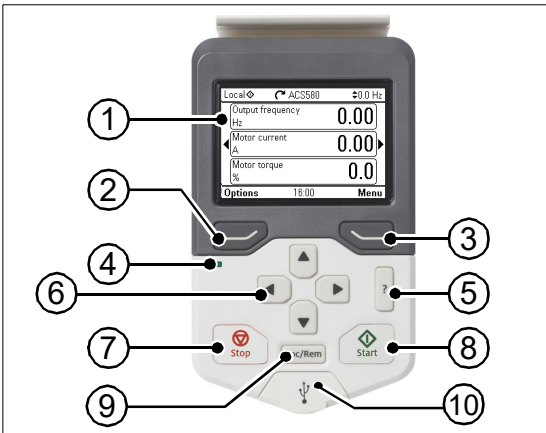

1	<a href="#">Layout of the control panel display</a>
2	<a href="#">Left softkey</a>
3	<a href="#">Right softkey</a>
4	Status LED, see chapter <i>Maintenance and hardware diagnostics</i> , section <i>LEDs in the Hardware manual of the drive</i> .
5	<a href="#">Help</a>

6	<a href="#">The arrow keys</a>
7	Stop (see <a href="#">Start and Stop</a> )
8	Start (see <a href="#">Start and Stop</a> )
9	Local/Remote (see <a href="#">Loc/Rem</a> )
10	USB connector

## Layout of the control panel display

In most views, the following elements are shown on the display:

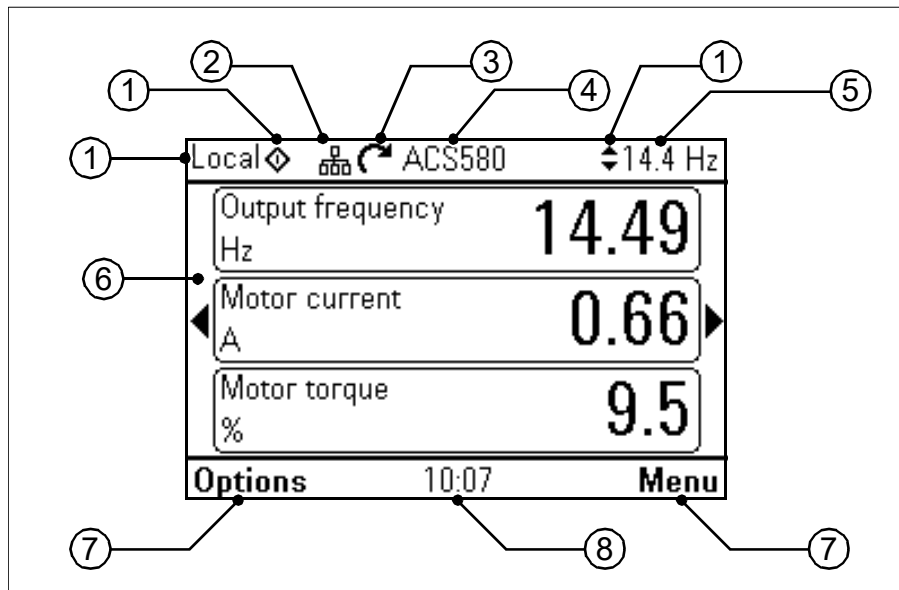



1. **Control location and related icons:** Indicates how the drive is controlled:





- **No text:** The drive is in local control, but controlled from another device. The icons in the top pane indicate which actions are allowed:

Text/icons	Starting from this control panel	Stopping from this control panel	Giving reference from this panel
	Not allowed	Not allowed	Not allowed









- **Local:** The drive is in local control, and controlled from this control panel. The icons in the top pane indicate which actions are allowed:



Text/icons	Starting from this control panel	Stopping from this control panel	Giving reference from this panel
Local  	Allowed	Allowed	Allowed

- **Remote:** The drive is in remote control, that is, controlled through I/O or fieldbus. The icons in the top pane indicate which actions are allowed with the control panel:

Text/Icons	Starting from this control panel	Stopping from this control panel	Giving reference from this panel
Remote	Not allowed	Not allowed	Not allowed
Remote 	Allowed	Allowed	Not allowed
Remote 	Not allowed	Allowed	Allowed
Remote  	Allowed	Allowed	Allowed

2. **Panel bus:** Indicates that there are more than one drive connected to this panel. To switch to another drive, go to **Options - Select drive**.
3. **Status icon:** Indicates the status of the drive and the motor. The direction of the arrow indicates forward (clockwise) or reverse (counter-clockwise) rotation.

Status icon	Animation	Drive status
	-	Stopped
	-	Stopped, start inhibited
	Blinking	Stopped, start command given but start inhibited. See <b>Menu - Diagnostics</b> on the control panel
	Blinking	Faulted
	Blinking	Running, at reference, but the reference value is 0
	Rotating	Running, not at reference
	Rotating	Running, at reference
	-	Pre-heating (motor heating) active
	-	PID sleep mode active

4. **Drive name:** If a name has been given, it is displayed in the top pane. By default, it is "ACS580". You can change the name on the control panel by selecting **Menu - Primary settings - Clock, region, display** (see page 66).
5. **Reference value:** Speed, frequency, etc. is shown with its unit. For information on changing the reference value in the **Primary settings** menu (see page 50) or in the **Options** menu (see page 75).
6. **Content area:** The actual content of the view is displayed in this area. The content varies from view to view. The example view on page 43 is the main view of the control panel which is called the Home view.
7. **Softkey selections:** Displays the functions of the softkeys ( and ) in a given context.
8. **Clock:** The clock displays the current time. You can change the time and time format on the control panel by selecting **Menu - Primary settings - Clock, region, display** (see page 66).

You can adjust the display contrast and back light functionality on the control panel by selecting **Menu - Primary settings - Clock, region, display** (see page 66).

## Home view displays

There are four different preconfigured basic configurable Home view displays for assistant panel. Home view 1 is the default Home view. You can browse them with the arrow keys (◀) and (▶). At first the bottom row shows the number of the Home view display, and after a while this is replaced by the time.

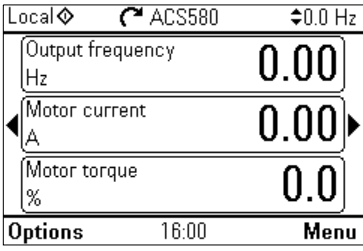
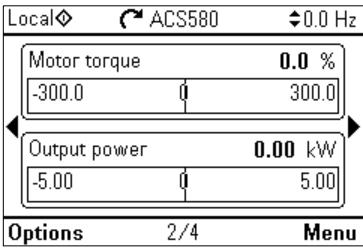
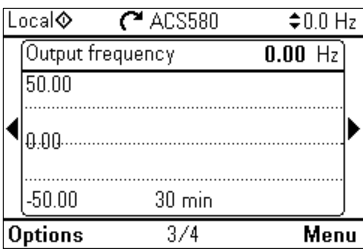
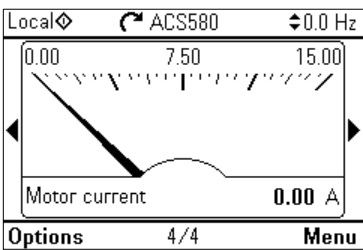
<p>Home view 1 (default Home view):</p> <ul style="list-style-type: none"> <li>• Output frequency (Hz): Parameter <a href="#">01.06 Output frequency</a></li> <li>• Motor current (A): Parameter <a href="#">01.07 Motor current</a></li> <li>• AI1 actual value (V or mA): Parameter <a href="#">12.11 AI1 actual value</a></li> </ul>	
<p>Home view 2:</p> <ul style="list-style-type: none"> <li>• Motor current (A): Parameter <a href="#">01.07 Motor current</a></li> <li>• Output power (kW): Parameter <a href="#">01.14 Output power</a></li> </ul>	
<p>Home view 3:</p> <ul style="list-style-type: none"> <li>• Output frequency shown as a graphical representation during the last 60 minutes: Parameter <a href="#">01.06 Output frequency</a></li> </ul>	
<p>Home view 4:</p> <ul style="list-style-type: none"> <li>• Motor current shown as a graphical representation during the last 60 minutes: Parameter <a href="#">01.07 Motor current</a></li> </ul>	

You can replace parameters in the Home view displays with other parameters or create new Home view displays showing selected parameters.

- Go to the Home view you want to edit and press the **Options** softkey (☰) and select **Edit Home view** (see page 75), or
- Go to the **Main** menu and select **Parameters**. Open the parameter and press the **Add to view** softkey and select a Home view display, or create a new one.

## Keys

The keys of the control panel are described below.



### Left softkey

The left softkey (☰) is usually used for exiting and canceling. Its function in a given situation is shown by the softkey selection in the bottom left corner of the display.

Holding ☰ down exits each view in turn until you are back in the Home view. This function does not work in special screens.

### Right softkey

The right softkey (☷) is usually used for selecting, accepting and confirming. The function of the right softkey in a given situation is shown by the softkey selection in the bottom right corner of the display.

### The arrow keys

The up and down arrow keys (⬆ and ⬇) are used to highlight selections in menus and selection lists, to scroll up and down on text pages, and to adjust values when, for example, setting the time, entering a passcode or changing a parameter value.

The left and right arrow keys (⬅ and ➡) are used to move the cursor left and right in parameter editing and to move forward and backward in assistants. In menus, ⬅ and ➡ function the same way as ☰ and ☷, respectively.

### Help

The help key (?) opens a help page. The help page is context-sensitive, in other words, the content of the page is relevant to the menu or view in question.

### Start and Stop



















In local control, the start key (⬆) and the stop key (⬇) starts and stops the drive, respectively.

**Loc/Rem**

The location key () is used for switching the control between the control panel (Local) and remote connections (Remote). When switching from Remote to Local while the drive is running, the drive keeps running at the same speed. When switching from Local to Remote, the status of the remote location is adopted.

**Key shortcuts**

The table below lists key shortcuts and combinations. Simultaneous key presses are indicated by the plus sign (+).

Shortcut	Available in	Effect
 +  + 	any view	Save a screenshot. Up to fifteen images may be stored in the control panel memory. To transfer images to PC, connect the assistant control panel to PC with a USB cable and the panel will mount itself as an MTP (media transfer protocol) device. Pictures are stored in the screen shots folder. For more instructions, see <i>ACx-AP-x assistant control panels user's manual</i> (3AUA0000085685 [English]).
 +  ,  + 	any view	Adjust backlight brightness.
 +  ,  + 	any view	Adjust display contrast.
 or 	Home view	Adjust reference.
 + 	parameter edit views	Revert an editable parameter to its default value.
 + 	view showing a list of selections for a parameter	Show/hide selection index numbers.
 (keep down)	any view	Return to the Home view by pressing down the key until the Home view is shown.





## 4

# Settings, I/O and diagnostics on the control panel

---

## Contents of this chapter

This chapter provides detailed information about the **Primary settings**, **I/O**, **Diagnostics**, **Systems info**, **Energy efficiency** and **Backups** menus on the control panel.

To get to the **Primary settings**, **I/O**, **Diagnostics**, **Systems info**, **Energy efficiency** or **Backups** menu from the Home view (see section [Home view displays](#) on page 45), first select **Menu** to go the **Main** menu, and in the **Main** menu, select the menu you want.

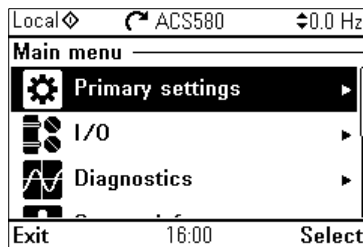
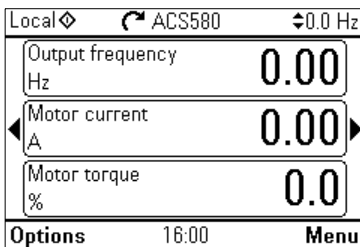

To read about the **Options** menu opening from the **Options** softkey () , see page [75](#).

---

## Primary settings menu

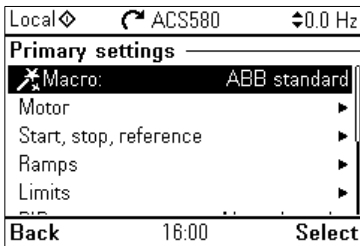

To go the **Primary settings** menu from the Home view, select **Menu - Primary settings**.



The **Primary settings** menu enables you to adjust and define additional settings used in the drive.

After making the guided settings using the first start assistant, ABB recommends that you make at least these additional settings:

- Select a **Macro** or set **Start, stop, reference** values
- **Ramps**
- **Limits**

With the **Primary settings** menu, you can also adjust settings related to the motor, PID, fieldbus, advanced functions and clock, region and display. In addition, you can reset the fault and event logs, control panel Home view, parameters not related to hardware, fieldbus settings, motor data and ID run results, all parameters, end user texts as well as reset everything to factory defaults.

Note that the **Primary settings** menu only enables you to modify some of the settings: more advanced configuration is done via the parameters: Select **Menu - Parameters**. For more information on the different parameters, see chapter [Parameters](#) on page 195.

In the **Setting** menu, the  symbol indicates multiple connected signals/parameters. The  symbol indicates that the setting provides an assistant when modifying the parameters.

To get more information on **Primary settings** menu items, press the  key to open the help page.

The figure below shows how to navigate in the **Primary settings** menu.

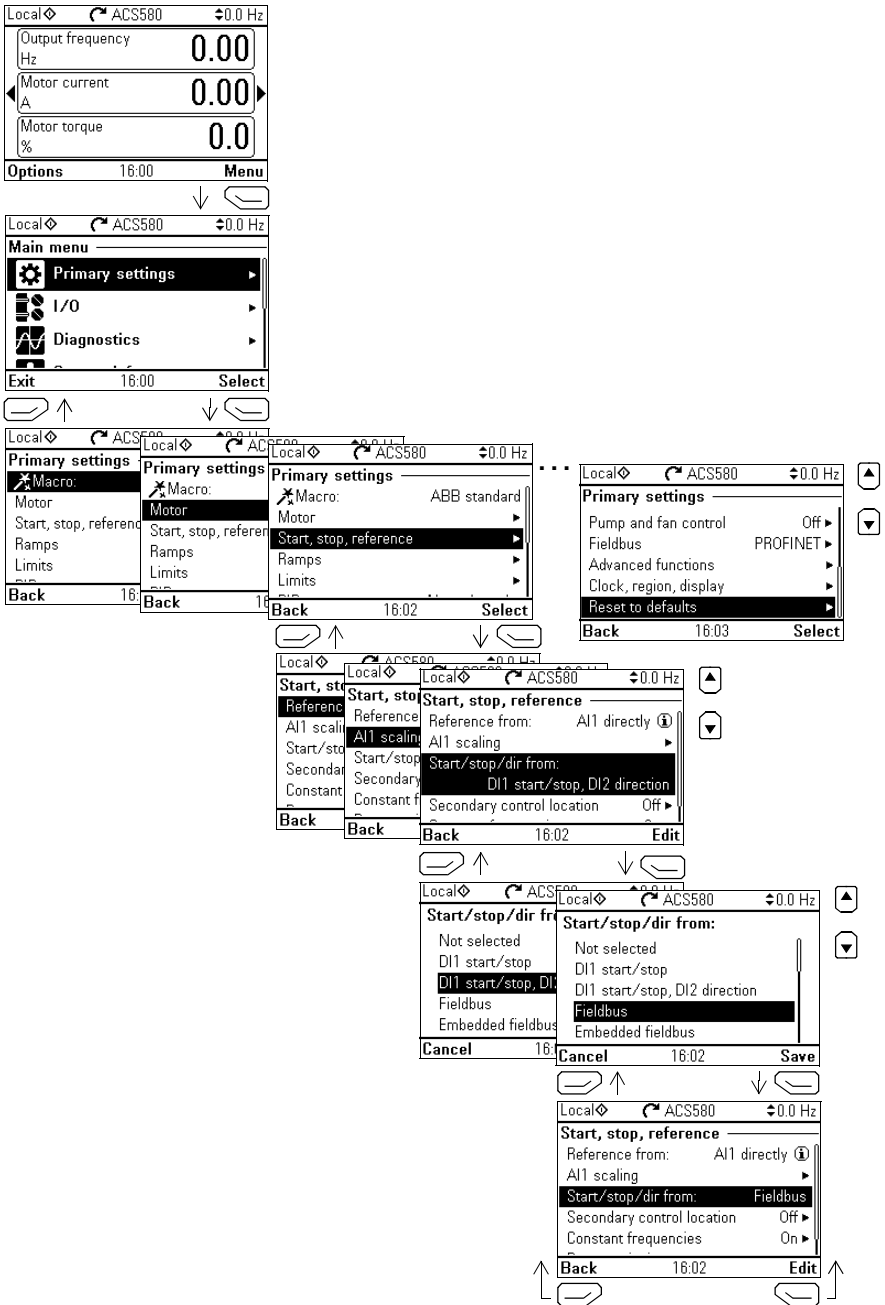

The sections below provide detailed information about the contents of the different submenus available in the **Primary settings** menu.

## ■ Macro

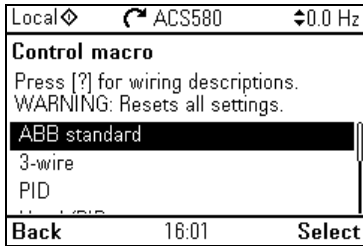

Use the **Macro** submenu to quickly set up drive control and reference source by selecting from a set of predefined wiring configurations.

**Note:** For detailed information about the available macros, see [Control macros](#) (page 77).

If you do not wish to use a macro, manually define the settings for **Start**, **stop**, **reference**. Note that even if you select to use a macro, you can also modify the other settings to suit your needs.

## ■ Motor

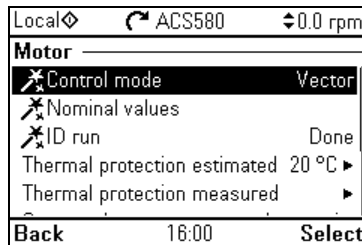
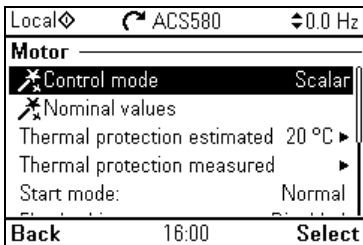

Use the **Motor** submenu to adjust motor-related settings, such as nominal values, control mode or thermal protection.

Note that settings that are visible depend on other selections, for example vector or scalar control mode, used motor type or selected start mode.

Three assistants are available: Control mode, Nominal value and ID run (for vector control mode only).

The table below provides detailed information about the available setting items in the **Motor** menu.

Menu item	Description	Corresponding parameter
Control mode	Selects whether to use scalar or vector control mode. For information on scalar control mode, see <a href="#">Scalar motor control</a> on page 156. For information on vector control mode, see <a href="#">Vector motor control</a> on page 157.	<a href="#">99.04 Motor control mode</a>
Nominal values	Enter the motor's nominal values from the motor's nameplate.	<a href="#">99.06 Motor nominal current ...</a> <a href="#">99.12 Motor nominal torque</a>
Thermal protection estimated	The settings in this submenu are meant to protect the motor from overheating by automatically triggering a fault or warning above a certain temperature. By default, motor thermal estimate protection is on. ABB recommends checking the values for the protection to function properly. For more information, see <a href="#">Motor thermal protection</a> on page 177.	<a href="#">35 Motor thermal protection</a>
Thermal protection measured	The settings in this submenu are meant to protect the motor with a thermal measurement from overheating by automatically triggering a fault or warning above a certain temperature. For more information, see <a href="#">Motor thermal protection</a> on page 177.	<a href="#">35 Motor thermal protection</a>
Start mode:	Sets how the drive starts the motor (for example pre-magnetize or not).	<a href="#">21 Start/stop mode</a>
Flux braking:	Sets how much current to use for braking, that is, how the motor is magnetized before starting. For more information, see <a href="#">Flux braking</a> on page 160.	<a href="#">97.05 Flux braking</a>
U/f ratio:	The form of voltage to frequency ratio below field weakening point.	<a href="#">97.20 U/F ratio</a>
IR compensation:	Sets how much to boost voltage at zero speed. Increase this for higher break-away torque. For more information, see <a href="#">IR compensation for scalar motor control</a> on page 157.	<a href="#">97.13 IR compensation</a>
Pre-heating	Turns pre-heating on or off. The drive can prevent condensation in a stopped motor by feeding it a fixed current (% of motor nominal current). Use in humid or cold conditions to prevent condensation.	<a href="#">21.14 Pre-heating input source</a> <a href="#">21.16 Pre-heating current</a>
Phase order:	If the motor turns in the wrong direction, change this setting to fix the direction instead of changing the phase order on the motor cable.	<a href="#">99.16 Motor phase order</a>

## Start, stop, reference

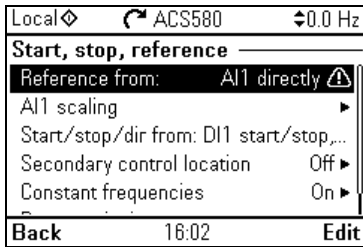

Use the **Start, stop, reference** submenu to set up start/stop commands, reference, and related features, such as constant speeds or run permissions.

The table below provides detailed information about the available setting items in the **Start, stop, reference** menu.

Menu item	Description	Corresponding parameter
Reference from	Sets where the drive gets its reference when remote control (EXT1) is active.	<a href="#">28.11 Ext1 frequency ref1</a> or <a href="#">22.11 Ext1 speed ref1</a> <a href="#">12.19 AI1 scaled at AI1 min</a>
Reference-related settings (e.g. AI scaling, AI2 scaling, Motor potentiometer settings) depending on the selected reference	The voltage or current fed to the input is converted into a value the drive can use (for example reference).	<a href="#">12.20 AI1 scaled at AI1 max</a>
Start/stop/dir from:	Sets where the drive gets start, stop, and (optionally) direction commands when remote control (EXT1) is active.	<a href="#">20.01 Ext1 commands</a>
Secondary control location	Settings for the secondary remote control location, EXT2. These settings include reference source, start, stop, direction and command sources for EXT2. By default, EXT2 is set to <b>Off</b> .	<a href="#">19.11 Ext1/Ext2 selection</a> <a href="#">28.15 Ext2 frequency ref1</a> or <a href="#">22.18 Ext2 speed ref1</a> <a href="#">12.17 AI1 min</a> <a href="#">12.18 AI1 max</a> <a href="#">12.27 AI2 min</a> <a href="#">12.28 AI2 max</a> <a href="#">20.06 Ext2 commands</a> <a href="#">20.08 Ext2 in1 source</a> <a href="#">20.09 Ext2 in2 source</a> <a href="#">20.10 Ext2 in3 source</a>

Menu item	Description	Corresponding parameter
Constant speeds / Constant frequencies	These settings are for using a constant value as the reference. By default, this is set to <b>On</b> . For more information, see <a href="#">Constant speeds/frequencies</a> on page 124.	<a href="#">28.21 Constant frequency function</a> or <a href="#">22.21 Constant speed function</a> <a href="#">28.26 Constant frequency 1</a> <a href="#">28.27 Constant frequency 2</a> <a href="#">28.28 Constant frequency 3</a> <a href="#">22.26 Constant speed 1</a> <a href="#">22.27 Constant speed 2</a> <a href="#">22.28 Constant speed 3</a>
Jogging	These settings allow you to use a digital input to briefly run the motor using predefined speed and acceleration/deceleration ramps. By default, jogging is disabled and it can only be used in the Vector control mode. For more information, see <a href="#">Jogging</a> on page 165.	<a href="#">20.25 Jogging enable</a> <a href="#">22.42 Jogging 1 ref</a> <a href="#">22.43 Jogging 2 ref</a> <a href="#">23.20 Acc time jogging</a> <a href="#">23.21 Dec time jogging</a>
Run permissions	Settings to prevent the drive from running or starting when a specific digital input is low.	<a href="#">20.12 Run enable 1 source</a> <a href="#">20.11 Run enable stop mode</a> <a href="#">20.19 Enable start command</a> <a href="#">20.22 Enable to rotate</a> <a href="#">21.05 Emergency stop source</a> <a href="#">21.04 Emergency stop mode</a> <a href="#">23.23 Emergency stop time</a>

## Ramps

Local	ACS580	0.0 Hz
<b>Ramps</b>		
Acceleration time:	20.000 s	
Deceleration time:	20.000 s	
Frequency scaling for ram...:	50.00 Hz	
Shape time:	0.000 s	
Stop mode:	Coast	
<b>Back</b>	16:02	<b>Edit</b>

Use the **Ramps** submenu to set up acceleration and deceleration settings.

**Note:** To set ramps, you also have to specify parameter [46.01 Speed scaling](#) (in speed control mode) or [46.02 Frequency scaling](#) (in frequency control mode).

The table below provides detailed information about the available setting items in the **Ramps** menu.

Menu item	Description	Corresponding parameter
Acceleration time:	This is the time between standstill and “scaling speed” when using the default ramps (set 1).	<a href="#">23.12 Acceleration time 1</a> <a href="#">28.72 Freq acceleration time 1</a>
Deceleration time:	This is the time between standstill and “scaling speed” when using the default ramps (set 1).	<a href="#">23.13 Deceleration time 1</a> <a href="#">28.73 Freq deceleration time 1</a>
Frequency scaling for ramps:	This is the maximum speed/frequency value for acceleration ramp rate and the initial value for deceleration ramp rate. Applies to both ramp sets.	<a href="#">46.02 Frequency scaling</a>
Shape time:	Sets the shape of the default ramps (set 1).	<a href="#">23.32 Shape time 1</a> <a href="#">28.82 Shape time 1</a>
Stop mode:	Sets how the drive stops the motor.	<a href="#">21.03 Stop mode</a>
Use two ramp sets	Sets the use of a second acceleration/deceleration ramp set. If unselected, only one ramp set is used. Note that if this selection is not enabled, the selections below are not available.	
Activate ramp set 2:	To switch ramp sets, you can either: <ul style="list-style-type: none"> <li>• use a digital input (low = set 1; high = set 2), or</li> <li>• automatically switch to set 2 above a certain frequency/speed.</li> </ul>	<a href="#">23.11 Ramp set selection</a> <a href="#">28.71 Freq ramp set selection</a>
Acceleration time 2:	Sets the time between standstill and “scaling speed” when using ramp set 2.	<a href="#">23.14 Acceleration time 2</a> <a href="#">28.74 Freq acceleration time 2</a>
Deceleration time 2:	Sets the time between standstill and “scaling speed” when using ramp set 2.	<a href="#">23.15 Deceleration time 2</a> <a href="#">28.75 Freq deceleration time 2</a>



Menu item	Description	Corresponding parameter
Shape time 2:	Sets the shape of ramps in set 2.	<a href="#">23.33 Shape time 2</a> <a href="#">28.83 Shape time 2</a>

## ■ Limits

Local ◊	ACS580	↕0.0 Hz
<b>Limits</b>		
Minimum frequency:	-50.00 Hz	
Maximum frequency:	50.00 Hz	
Maximum current:	3.24 A	
<b>Back</b>	16:03	<b>Edit</b>

Use the **Limits** submenu to set the allowed operating range. This function is intended to protect the motor, connected hardware and mechanics. The drive stays within these limits, no matter what reference value it gets.

**Note:** To set ramps, you also have to specify parameter [46.01 Speed scaling](#) (in speed control mode) or [46.02 Frequency scaling](#) (in frequency control mode); these limit parameters have no effect on ramps.

The table below provides detailed information about the available setting items in the **Limits** menu.

Menu item	Description	Corresponding parameter
Minimum frequency	Sets the minimum operating frequency. Affects scalar control only.	<a href="#">30.13 Minimum frequency</a>
Maximum frequency	Sets the maximum operating frequency. Affects scalar control only.	<a href="#">30.14 Maximum frequency</a>
Minimum speed	Sets the minimum operating speed. Affects vector control only.	<a href="#">30.11 Minimum speed</a>
Maximum speed	Sets the maximum operating speed. Affects vector control only.	<a href="#">30.12 Maximum speed</a>
Minimum torque	Sets the minimum operating torque. Affects vector control only.	<a href="#">30.19 Minimum torque 1</a>
Maximum torque	Sets the maximum operating torque. Affects vector control only.	<a href="#">30.20 Maximum torque 1</a>
Maximum current	Sets the maximum output current.	<a href="#">30.17 Maximum current</a>

## PID

Local	ACS580	0.0 Hz
<b>PID</b>		
PID is controlling:	Not selected	
PID output:	0.00	▶
Unit:	°C	
Deviation:	0.00 °C	▶
Setpoint:	0.00 °C	▶
<b>Back</b>	16:02	<b>Edit</b>

The **PID** submenu contains settings and actual values for the process PID controller for controlling multiple pumps or fans through the drive's relay outputs.

The table below provides detailed information about the available setting items in the **PID** menu.

Menu item	Description	Corresponding parameter
PID is controlling:	Sets what to use PID output for: <ul style="list-style-type: none"> <li>• <b>Not selected:</b> PID not used.</li> <li>• <b>Frequency reference (or Speed reference,</b> depending on the motor control mode): Uses PID output as a frequency (speed) reference when remote control (EXT1) is active.</li> </ul>	<a href="#">40.07 Process PID operation mode</a>
PID output:	View the process PID output or set its range.	<a href="#">40.01 Process PID output actual</a> <a href="#">40.36 Set 1 output min</a> <a href="#">40.37 Set 1 output max</a>
Unit:	PID customer unit. Sets the text shown as the unit for setpoint, feedback and deviation.	
Deviation:	View or invert process PID deviation.	<a href="#">40.04 Process PID deviation actual</a> <a href="#">40.31 Set 1 deviation inversion</a>
Setpoint:	View or configure the process PID setpoint, that is, the target process value.  You can also use a constant setpoint value instead of (or in addition to) an external setpoint source. When a constant setpoint is active, it overrides the normal setpoint.	<a href="#">40.03 Process PID setpoint actual</a> <a href="#">40.16 Set 1 setpoint 1 source</a>
Feedback:	View or configure process PID feedback, that is, the measured value.	<a href="#">40.02 Process PID feedback actual</a> <a href="#">40.08 Set 1 feedback 1 source</a> <a href="#">40.11 Set 1 feedback filter time</a>

Menu item	Description	Corresponding parameter
Tuning	<p>The <b>Tuning</b> submenu contains settings for gain, integration time and derivation time.</p> <ol style="list-style-type: none"> <li>1. Make sure it is safe to start the motor and run the actual process.</li> <li>2. Start the motor in remote control.</li> <li>3. Change setpoint by a small amount.</li> <li>4. Watch how feedback reacts.</li> <li>5. Adjust gain/integration/derivation.</li> <li>6. Repeat steps 3-5 until feedback reacts as desired.</li> </ol>	<p><a href="#">40.32 Set 1 gain</a>  <a href="#">40.33 Set 1 integration time</a>  <a href="#">40.34 Set 1 derivation time</a>  <a href="#">40.35 Set 1 derivation filter time</a></p>
Sleep function	<p>The sleep function can be used to save energy by stopping the motor during low demand. By default, sleep function is disabled. If enabled, the motor automatically stops when demand is low, and starts again when deviation grows too large. This saves energy when rotating the motor at low speeds would be useless.</p> <p>See section <a href="#">Sleep and boost functions for process PID control</a> on page 132.</p>	<p><a href="#">40.43 Set 1 sleep level</a>  <a href="#">40.44 Set 1 sleep delay</a>  <a href="#">40.45 Set 1 sleep boost time</a>  <a href="#">40.46 Set 1 sleep boost step</a>  <a href="#">40.47 Set 1 wake-up deviation</a>  <a href="#">40.48 Set 1 wake-up delay</a></p>

## ■ Pump and fan control

Local	ACS580	0.0 Hz
<b>Pump and fan control</b>		
PFC mode:	PFC	
Configure PFC I/O	▶	
Configure PFC control	▶	
Configure Autochange	Not selected ▶	
<b>Back</b>	16:02	<b>Edit</b>

The **Pump and fan control** submenu contains settings for the Pump and fan control logic. The Pump and fan control is supported in external control location EXT2 only.

The table below provides detailed information about the available setting items in the **Pump and fan control** menu.

Menu item	Description	Corresponding parameter
PFC mode:	See section <a href="#">Pump and fan control (PFC)</a> on page 142. Selects the PFC or SPFC control.	<a href="#">76.21 Multipump configuration</a>
Configure PFC I/O	Configures PFC/SPFC I/O. <ul style="list-style-type: none"> <li>Number of motors</li> <li>ROs</li> <li>Interlocks</li> <li>Check I/O configuration (See <a href="#">I/O menu</a> on page 69.)</li> </ul>	<a href="#">76.25 Number of motors</a> <a href="#">76.27 Max number of motors allowed</a> <a href="#">76.59 PFC contactor delay</a> <a href="#">10.24 RO1 source</a> <a href="#">10.27 RO2 source</a> <a href="#">10.30 RO3 source</a> <a href="#">76.81 PFC 1 interlock</a> <a href="#">76.82 PFC 2 interlock</a> <a href="#">76.83 PFC 3 interlock</a> <a href="#">76.84 PFC 4 interlock</a> <a href="#">76.85 PFC 5 interlock</a> <a href="#">76.86 PFC 6 interlock</a>
Configure PFC control	Configures PFC/SPFC control	<a href="#">76.30 Start point 1</a> <a href="#">76.31 Start point 2</a> <a href="#">76.32 Start point 3</a> <a href="#">76.33 Start point 4</a> <a href="#">76.34 Start point 5</a> <a href="#">76.41 Stop point 1</a> <a href="#">76.42 Stop point 2</a> <a href="#">76.43 Stop point 3</a> <a href="#">76.44 Stop point 4</a> <a href="#">76.45 Stop point 5</a> <a href="#">76.55 Start delay</a> <a href="#">76.56 Stop delay</a>
Configure Autochange	Configures Autochange	<a href="#">76.70 PFC autochange interval</a> <a href="#">76.71 PFC autochange interval</a> <a href="#">76.72 Maximum wear imbalance</a> <a href="#">76.73 Autochange level</a>

## Fieldbus

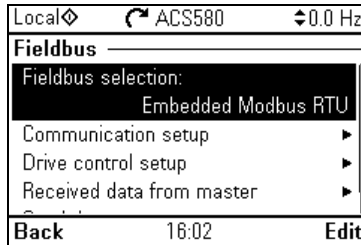
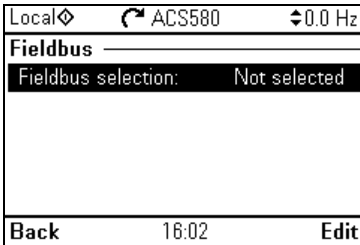

Use the settings in the **Fieldbus** submenu to use the drive with a fieldbus:

- CANopen
- ControlNet
- DeviceNet™
- Ethernet POWERLINK
- EtherCAT
- Ethernet/IP™
- RS-485
- Modbus (RTU or TCP)
- PROFIBUS DP
- PROFINET IO

You can also configure all the fieldbus related settings via the parameters (parameter groups [50 Fieldbus adapter \(FBA\)](#), [51 FBA A settings](#), [52 FBA A data in](#), [53 FBA A data out](#), [58 Embedded fieldbus](#)), but the purpose of the **Fieldbus** menu is to make the protocol configurations easier.

Note that only Modbus RTU is embedded and the other fieldbus modules are optional adapters. For the optional modules, the following adapters are required to the needed protocols:

- CANopen: FCAN-01
- ControlNet: FCNA-01
- DeviceNet™: FDNA-01
- Ethernet POWERLINK: FEPL-02
- EtherCAT: FECA-01
- Ethernet/IP™: FENA-21
- Modbus/TCP: FMBT-21, FENA-21
- RS-485: FSCA-01
- PROFIBUS DP: FPBA-01
- PROFINET IO: FENA-21

The table below provides detailed information about the available setting items in the **Fieldbus** menu. Note that some of the items only become active once you have enabled fieldbus.

Menu item	Description	Corresponding parameter
Fieldbus selection	Select this if you want to use the drive with a fieldbus.	<a href="#">51.01 FBA A type</a> <a href="#">58.01 Protocol enable</a>
Communication setup	To set up communication between the drive and the fieldbus master, define these settings and then select <b>Apply settings to fieldbus module</b> .	<a href="#">51 FBA A settings</a> <a href="#">51.01 FBA A type</a> <a href="#">51.02 FBA A Par2</a> <a href="#">51.27 FBA A par refresh</a> <a href="#">51.31 D2FBA A comm status</a> <a href="#">50.13 FBA A control word</a> <a href="#">50.16 FBA A status word</a> <a href="#">58 Embedded fieldbus</a> <a href="#">58.01 Protocol enable</a> <a href="#">58.03 Node address</a> <a href="#">58.04 Baud rate</a> <a href="#">58.05 Parity</a> <a href="#">58.25 Control profile</a>
Drive control setup	Sets how a fieldbus master can control this drive, and how the drive reacts if the fieldbus communication fails.	<a href="#">20.01 Ext1 commands</a> <a href="#">19.11 Ext1/Ext2 selection</a> <a href="#">22.11 Ext1 speed ref1</a> <a href="#">28.11 Ext1 frequency ref1</a> <a href="#">22.41 Speed ref safe</a> <a href="#">28.41 Frequency ref safe</a> <a href="#">50.03 FBA A comm loss t out</a> <a href="#">46.01 Speed scaling</a> <a href="#">46.02 Frequency scaling</a> <a href="#">23.12 Acceleration time 1</a> <a href="#">23.13 Deceleration time 1</a> <a href="#">28.72 Freq acceleration time 1</a> <a href="#">28.73 Freq deceleration time 1</a> <a href="#">51.27 FBA A par refresh</a> <a href="#">58.14 Communication loss action</a> <a href="#">58.15 Communication loss mode</a> <a href="#">58.16 Communication loss time</a>
Received data from master	Sets what the drive's fieldbus module expects to receive from the fieldbus master (PLC). After changing these settings, select <b>Apply settings to fieldbus module</b> .	<a href="#">50.13 FBA A control word</a> <a href="#">53 FBA A data out</a> <a href="#">51.27 FBA A par refresh</a> <a href="#">58.18 EFB control word</a> <a href="#">03.09 EFB reference 1</a>

Menu item	Description	Corresponding parameter
Send data to master	Sets what the drive's fieldbus module sends to the fieldbus master (PLC). After changing these settings, select <b>Apply settings to fieldbus module</b> .	<a href="#">50.16 FBA A status word</a> <a href="#">52 FBA A data in</a> <a href="#">51.27 FBA A par refresh</a> <a href="#">58.19 EFB status word</a>
Apply settings to fieldbus module	Applies modified settings to the fieldbus module.	<a href="#">51.27 FBA A par refresh</a> <a href="#">58.06 Communication control</a>

## ■ Advanced functions

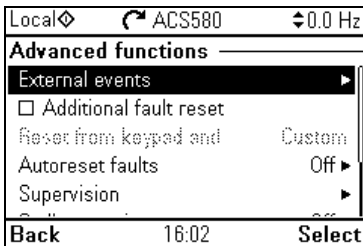

The **Advanced functions** submenu contains settings for advanced functions, such as triggering or resetting faults via I/O, signal supervision, using the drive with timed functions, or switching between several entire sets of settings.

The table below provides detailed information about the available setting items in the **Advanced functions** menu.

Menu item	Description	Corresponding parameter
External events	Enables you to define custom faults or warnings you can trigger via digital input. The texts of these messages are customizable.	<a href="#">31.01 External event 1 source</a> <a href="#">31.02 External event 1 type</a> <a href="#">31.03 External event 2 source</a> <a href="#">31.04 External event 2 type</a> <a href="#">31.05 External event 3 source</a> <a href="#">31.06 External event 3 type</a>
Additional fault reset	You can reset an active fault via I/O: a rising pulse in the selected input means reset. A fault can be reset from the fieldbus even if <b>Reset faults manually</b> is unselected.	<a href="#">31.11 Fault reset selection</a>
Reset from keypad and...	Define from where you want to reset faults manually. Note that this submenu is active only if you have selected to reset faults manually.	<a href="#">31.11 Fault reset selection</a>

Menu item	Description	Corresponding parameter
Autoreset faults	Reset faults automatically. For more information, see <a href="#">Automatic fault resets</a> on page 185.	<a href="#">31.12 Autoreset selection</a> <a href="#">31.14 Number of trials</a> <a href="#">31.15 Total trials time</a> <a href="#">31.16 Delay time</a>
Supervision	You can select three signals to be supervised. If a signal is outside predefined limits a fault or warning is generated. For complete settings, see group <a href="#">32 Supervision</a> on page 319.	<a href="#">32.01 Supervision status</a> <a href="#">32.05 Supervision 1 function</a> <a href="#">32.06 Supervision 1 action</a> <a href="#">32.07 Supervision 1 signal</a> <a href="#">32.09 Supervision 1 low</a> <a href="#">32.10 Supervision 1 high</a> <a href="#">32.11 Supervision 1 hysteresis</a> ... <a href="#">32.25 Supervision 3 function</a> <a href="#">32.26 Supervision 3 action</a> <a href="#">32.27 Supervision 3 signal</a> <a href="#">32.29 Supervision 3 low</a> <a href="#">32.30 Supervision 3 high</a> <a href="#">32.31 Supervision 3 hysteresis</a>
Stall protection	The drive can detect a motor stall and automatically fault or show a warning message. Stall condition is detected when: <ul style="list-style-type: none"> <li>• current is high (above certain % of motor nominal current), and</li> <li>• output frequency (scalar control) or motor speed (vector control) is below a certain limit, and</li> <li>• the conditions above have been true for a certain minimum duration.</li> </ul>	<a href="#">31.24 Stall function</a> <a href="#">31.25 Stall current limit</a> <a href="#">31.26 Stall speed limit</a> <a href="#">31.27 Stall frequency limit</a> <a href="#">31.28 Stall time</a>



Menu item	Description	Corresponding parameter
Timed functions	Enables using the drive with timed functions. For complete settings, see group <a href="#">34 Timed functions</a> on page <a href="#">327</a> .	<a href="#">34.100 Timed function 1</a> <a href="#">34.101 Timed function 2</a> <a href="#">34.102 Timed function 3</a> <a href="#">34.11 Timer 1 configuration</a> <a href="#">34.12 Timer 1 start time</a> <a href="#">34.13 Timer 1 duration</a> ... <a href="#">34.44 Timer 12 configuration</a> <a href="#">34.45 Timer 12 start time</a> <a href="#">34.46 Timer 12 duration</a> <a href="#">34.111 Boost time activation source</a> <a href="#">34.112 Boost time duration</a>
User sets	This submenu enables you to save multiple sets of settings for easy switching. For more information about user sets, see <a href="#">User parameter sets</a> on page <a href="#">190</a> .	<a href="#">96.11 User set save/load</a> <a href="#">96.10 User set status</a> <a href="#">96.12 User set I/O mode in1</a> <a href="#">96.13 User set I/O mode in2</a>

## ■ Clock, region, display

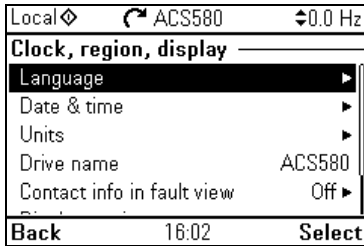

The **Clock, region, display** submenu contains settings for language, date and time, display (such as brightness) and settings for changing how information is displayed on screen.

The table below provides detailed information about the available setting items in the **Clock, region, display** menu.

Menu item	Description	Corresponding parameter
Language	Change the language used on the control panel screen. Note that the language is loaded from the drive so this takes some time.	<a href="#">96.01 Language</a>
Date & time	Set the time and date, and their formats.	
Units	Select the units used for power, temperature and torque.	
Drive name:	The drive name defined in this setting is shown in the status bar at the top of the screen while using the drive. If more than one drives are connected to the control panel, the drive names make it easy to identify each drive. It also identifies any backups you create for this drive.	
Contact info in fault view	Define a fixed text that is shown during any fault (for example, who to contact in case of a fault). If a fault occurs, this information appears on the control panel screen (in addition to the fault-specific information).	
Display settings	Adjust the brightness, contrast and display power save delay of the control panel screen or to invert white and black.	
Show in lists	Show or hide the numeric IDs of: <ul style="list-style-type: none"> <li>• parameters and groups</li> <li>• option list items</li> <li>• bits</li> <li>• devices in <b>Options &gt; Select drive</b></li> </ul>	
Show inhibit pop-up	Enables or disables pop-up views showing information on inhibits, for example when you try to start the drive but it is prevented.	

## Reset to defaults

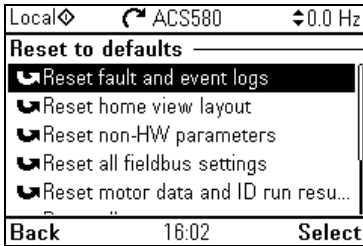

The **Reset to defaults** submenu enables you to reset parameters and other settings.

Menu item	Description	Corresponding parameter
Reset fault and event logs	Clears all events from the drive's fault and event logs.	<a href="#">96.51 Clear fault and event logger</a>
Reset home view layout	Restores the Home view layout back to show the values of the default parameters defined by the control macro in use.	<a href="#">96.06 Parameter restore</a> , selection <a href="#">Reset home view</a>
Reset non-HW parameters	Restores all editable parameter values to default values, except <ul style="list-style-type: none"> <li>motor data and ID run results</li> <li>I/O extension module settings</li> <li>end user texts, such as customized warnings and faults, and the drive name</li> <li>control panel/PC communication settings</li> <li>fieldbus adapter settings</li> <li>control macro selection and the parameter defaults</li> <li>parameter <a href="#">95.01 Supply voltage</a></li> <li>differentiated defaults implemented by parameters <a href="#">95.20 HW options word 1</a> and <a href="#">95.21 HW options word 2</a></li> <li>user lock configuration parameters <a href="#">96.100...96.102</a>.</li> </ul>	<a href="#">96.06 Parameter restore</a> , selection <a href="#">Restore defaults</a>
Reset all fieldbus settings	Restores all fieldbus and communication related settings to default values. <b>Note:</b> Fieldbus, control panel and PC tool communication are interrupted during the restore.	<a href="#">96.06 Parameter restore</a> , selection <a href="#">Reset all fieldbus settings</a>
Reset motor data and IR run results	Restores all motor nominal values and motor ID run results to default values.	<a href="#">96.06 Parameter restore</a> , selection <a href="#">Reset motor data</a>

Menu item	Description	Corresponding parameter
Reset all parameters	Restores all editable parameter values to default values, except <ul style="list-style-type: none"> <li>• end user texts, such as customized warnings and faults, and the drive name</li> <li>• control panel/PC communication</li> <li>• settings control macro selection and the parameter defaults</li> <li>• <a href="#">parameter 95.01 Supply voltage</a></li> <li>• differentiated defaults implemented by parameters <a href="#">95.20 HW options word 1</a> and <a href="#">95.21 HW options word 2</a></li> <li>• user lock configuration parameters <a href="#">96.100...96.102</a></li> <li>• group <a href="#">49 Panel port communication</a> parameters.</li> </ul>	<a href="#">96.06 Parameter restore</a> , selection <a href="#">Clear all</a>
Reset end user texts	Restores all end user texts to default values, including the drive name, contact info, customized fault and warning texts, PID unit and currency unit.	<a href="#">96.06 Parameter restore</a> , selection <a href="#">Reset end user texts</a>
Reset all to factory defaults	Restores settings and all editable parameters back to initial factory values, except <ul style="list-style-type: none"> <li>• differentiated defaults implemented by parameters <a href="#">95.20 HW options word 1</a> and <a href="#">95.21 HW options word 2</a>.</li> </ul>	<a href="#">96.06 Parameter restore</a> , selection <a href="#">All to factory defaults</a>

## I/O menu

Local ◊	ACS580	↕ 0.0 Hz
<b>I/O</b>		
DI1: 0		Start/stop ▶
DI2: 1		Direction ▶
DI3: 0	Used in several places ▶	
DI4: 0	Used in several places ▶	
DI5: 0	Switch to ramp set 2 ▶	
Back	16:03	Select

To go the **I/O** menu from the Home view, select **Menu - I/O**.

Use the **I/O** menu to make sure that the actual I/O wiring matches the I/O use in the control program. It answers the questions:

- What is each input being used for?
- What is the meaning of each output?

In the **I/O** menu, each row provides the following information:

- Terminal name and number
- Electrical status
- Logical meaning of the drive

Each row also provides a submenu that provides further information on the menu item and lets you make changes to the I/O connections.

The table below provides detailed information about the contents of the different submenus available in the **I/O** menu.

Menu item	Description
DI1	This submenu lists the functions that use DI1 as input.
DI2	This submenu lists the functions that use DI2 as input.
DI3	This submenu lists the functions that use DI3 as input.
DI4	This submenu lists the functions that use DI4 as input.
DI5	This submenu lists the functions that use DI5 or FI as input. The connector can be used as either digital input or frequency input.
DI6	This submenu lists the functions that use DI6 as input. The connector can be used as either digital input or thermistor input.
AI1	This submenu lists the functions that use AI1 as input.
AI2	This submenu lists the functions that use AI2 as input.
RO1	This submenu lists what information goes into relay output 1.
RO2	This submenu lists what information goes into relay output 2.
RO3	This submenu lists what information goes into relay output 3.
AO1	This submenu lists what information goes into AO1.
AO2	This submenu lists what information goes into AO2.

## Diagnostics menu

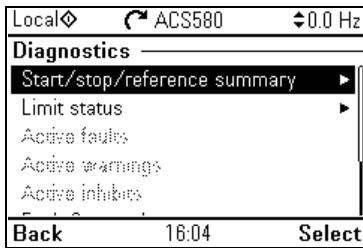

To go the **Diagnostics** menu from the Home view, select **Menu - Diagnostics**.

The **Diagnostics** menu provides you with diagnostic information, such as faults and warnings, and helps you to resolve potential problems. Use the menu to make sure that the drive setup is functioning correctly.

The table below provides detailed information about the contents of the different views available in the **Diagnostics** menu.

Menu item	Description
Start, stop, reference summary	This view shows where the drive is currently taking its start and stop commands and reference. The view is updated in real time. If the drive is not starting or stopping as expected, or runs at an undesired speed, use this view to find out where the control comes from.
Limit status	This view describes any limits currently affecting operation. If the drive is running at undesired speed, use this view to find out if any limitations are active.
Active faults	This view shows the currently active faults and provides instructions on how to fix and reset them.
Active warnings	This view shows the currently active warnings and provides instructions on how to fix them.
Active inhibits	This view shows up to five simultaneous active start inhibits and how to fix them.
Fault & event log	This view lists the faults, warnings and other events that have occurred in the drive. Press <b>Details</b> to see, for each stored fault, the fault code, time and values of parameters (actual signals and status words) <a href="#">05.80</a> ... stored at the time of the fault.
Fieldbus	This view provides status information and sent and received data from fieldbus for troubleshooting.
Load profile	This view provides status information regarding load distribution (that is, how much of the drive's running time was spent on each load level) and peak load levels.

## System info menu

Local	ACS580	0.0 Hz
<b>System info</b>		
Drive	▶	
Control panel	▶	
QR code	▶	
Option slot 1 name	FENA-21	▶
<b>Back</b>	16:05	<b>Select</b>

To go the **System info** menu from the Home view, select **Menu - System info**.

The **System info** menu shows information about the drive and the control panel. In problem situations you can also request the drive to generate a QR code for ABB service, so they can better assist you.

The table below shows the different views in the **System info** menu.

Menu item	Description	Corresponding parameter																											
Drive	Shows the following information about the drive: <table border="1" data-bbox="344 730 706 975"> <tr> <td>Local</td> <td>ACS580</td> <td>0.0 Hz</td> </tr> <tr> <td colspan="3"><b>Drive</b></td> </tr> <tr> <td>Panel bus id:</td> <td colspan="2">1</td> </tr> <tr> <td>Product name:</td> <td colspan="2">ACS580</td> </tr> <tr> <td>Product type:</td> <td colspan="2">ACS580</td> </tr> <tr> <td>FW version:</td> <td colspan="2">ASCK2 v2.04.0.0</td> </tr> <tr> <td>LP version:</td> <td colspan="2">ASCD2 v2.04.0.0</td> </tr> <tr> <td>Backup version:</td> <td colspan="2">00.01.00.00</td> </tr> <tr> <td><b>Back</b></td> <td colspan="2">16:05</td> </tr> </table>	Local	ACS580	0.0 Hz	<b>Drive</b>			Panel bus id:	1		Product name:	ACS580		Product type:	ACS580		FW version:	ASCK2 v2.04.0.0		LP version:	ASCD2 v2.04.0.0		Backup version:	00.01.00.00		<b>Back</b>	16:05		<a href="#">07.05 Firmware version</a> <a href="#">07.07 Loading package version</a>
Local	ACS580	0.0 Hz																											
<b>Drive</b>																													
Panel bus id:	1																												
Product name:	ACS580																												
Product type:	ACS580																												
FW version:	ASCK2 v2.04.0.0																												
LP version:	ASCD2 v2.04.0.0																												
Backup version:	00.01.00.00																												
<b>Back</b>	16:05																												
Control panel	Shows the following information about the control panel: <table border="1" data-bbox="344 1050 706 1294"> <tr> <td>Local</td> <td>ACS580</td> <td>0.0 Hz</td> </tr> <tr> <td colspan="3"><b>Control panel</b></td> </tr> <tr> <td>Product type:</td> <td colspan="2">ACS-AP-S</td> </tr> <tr> <td>HW version:</td> <td colspan="2">D</td> </tr> <tr> <td></td> <td colspan="2">Flash AT32</td> </tr> <tr> <td>FW version:</td> <td colspan="2">GPAPS v5.80</td> </tr> <tr> <td>Serial number:</td> <td colspan="2">D3381633SB</td> </tr> <tr> <td>Manufacturing date:</td> <td colspan="2">11.10.2013</td> </tr> <tr> <td><b>Back</b></td> <td colspan="2">16:05</td> </tr> </table>	Local	ACS580	0.0 Hz	<b>Control panel</b>			Product type:	ACS-AP-S		HW version:	D			Flash AT32		FW version:	GPAPS v5.80		Serial number:	D3381633SB		Manufacturing date:	11.10.2013		<b>Back</b>	16:05		
Local	ACS580	0.0 Hz																											
<b>Control panel</b>																													
Product type:	ACS-AP-S																												
HW version:	D																												
	Flash AT32																												
FW version:	GPAPS v5.80																												
Serial number:	D3381633SB																												
Manufacturing date:	11.10.2013																												
<b>Back</b>	16:05																												

Menu item	Description	Corresponding parameter																		
QR code	<p>The drive generates a QR code (or a series of QR codes), which contains drive identification data, information on the latest events, and values of status and counter parameters. You can read the QR code with a mobile device containing the ABB service application, which then sends the QR code to ABB for analysis.</p> 																			
Option slot x name	<p>Shows the following information about the option in the slot:</p> <table border="1" data-bbox="292 695 654 943"> <tr> <td>Local</td> <td>ACS580</td> <td>0.0 Hz</td> </tr> <tr> <td>Serial number:</td> <td colspan="2">41746A0053</td> </tr> <tr> <td>Option slot 1 name:</td> <td colspan="2">FENA-21</td> </tr> <tr> <td>Option slot 1 SW ver:</td> <td colspan="2">FFPNS00</td> </tr> <tr> <td>Option slot 1 MRP:</td> <td colspan="2">3AJA0000089108</td> </tr> <tr> <td><b>Back</b></td> <td colspan="2">16:06</td> </tr> </table>	Local	ACS580	0.0 Hz	Serial number:	41746A0053		Option slot 1 name:	FENA-21		Option slot 1 SW ver:	FFPNS00		Option slot 1 MRP:	3AJA0000089108		<b>Back</b>	16:06		
Local	ACS580	0.0 Hz																		
Serial number:	41746A0053																			
Option slot 1 name:	FENA-21																			
Option slot 1 SW ver:	FFPNS00																			
Option slot 1 MRP:	3AJA0000089108																			
<b>Back</b>	16:06																			



## Energy efficiency menu

Local	ACS580	0.0 Hz
<b>Energy efficiency</b>		
Saved energy	0.0 kWh	
Saved amount	0.00 €	
Total saved CO2	0.0 metric ton	
Current hour kWh	0.00 kWh	
Previous hour kWh	0.00 kWh	
<b>Back</b>	16:06	<b>View</b>

To go the **Energy efficiency** menu from the Home view, select **Menu - Energy efficiency**.

The **Energy efficiency** menu provides you with information about energy efficiency, such as saved energy and energy consumption. You can also configure energy calculation settings.

The table below lists the energy efficiency values shown in the **Energy efficiency** menu, as well as configurable energy calculation settings.

Menu item	Description	Corresponding parameter
Saved energy	Energy saved in kWh compared to direct-on-line motor connection.	<a href="#">45.04 Saved energy</a>
Saved amount	Corresponding money saved compared to direct-on-line motor connection. You can define the currency unit you want to use in submenu <b>Configuration</b> .	<a href="#">45.07 Saved amount</a>
Total saved CO2	Reduction in CO2 emissions in metric tons compared to direct-on-line motor connection.	<a href="#">45.10 Total saved CO2</a>
Current hour kWh	Current hour energy consumption. This is the energy of the last 60 minutes (not necessarily continuous) the drive has been running, not the energy of a calendar hour.	<a href="#">01.50 Current hour kWh</a>
Previous hour kWh	Previous hour energy consumption. The value of <a href="#">01.51 Previous hour kWh</a> is stored here when its values has been cumulated for 60 minutes.	<a href="#">01.51 Previous hour kWh</a>
Current day kWh	Current day energy consumption. This is the energy of the last 24 hours (not necessarily continuous) the drive has been running, not the energy of a calendar day.	<a href="#">01.52 Current day kWh</a>
Previous day kWh	Previous day energy consumption. The value of <a href="#">01.53 Previous day kWh</a> is stored here when its value has been cumulated for 24 hours.	<a href="#">01.53 Previous day kWh</a>
<b>Configuration</b>	In this submenu, you can configure energy calculation settings.	

Menu item	Description	Corresponding parameter
Energy optimizer	Enables/disables the energy optimization function. The function optimizes the motor flux so that total energy consumption and motor noise level are reduced when the drive operates below the nominal load. The total efficiency (motor and drive) can be improved by 1...20% depending on load torque and speed	<a href="#">45.11 Energy optimizer</a>
Energy tariff 1	Defines energy tariff 1 (price of energy per kWh). Depending on the setting of parameter <a href="#">45.14 Tariff selection</a> , either this value or <a href="#">45.13 Energy tariff 2</a> is used for reference when monetary savings are calculated.	<a href="#">45.12 Energy tariff 1</a>
Energy tariff 1	Defines energy tariff 2 (price of energy per kWh).	<a href="#">45.13 Energy tariff 2</a>
Tariff selection	Selects (or defines a source that selects) which pre-defined energy tariff is used.	<a href="#">45.14 Tariff selection</a>
CO2 conversion factor	Defines a factor for conversion of saved energy into CO2 emissions (kg/kWh or tn/MWh).	<a href="#">45.18 CO2 conversion factor</a>
Comparison power	Actual power that the motor absorbs when connected direct-on-line and operating the application. The value is used for reference when energy savings are calculated.	<a href="#">45.19 Comparison power</a>
Energy calculations reset	Resets the savings counter parameters, eg. <a href="#">45.04 Saved energy...</a> <a href="#">45.10 Total saved CO2</a> .	<a href="#">45.21 Energy calculations reset</a>
Currency	Defines the currency unit you want to use in energy calculations.	

## Backups menu

Local	ACS580	0.0 Hz
<b>Backups</b>		
Create backup ▶		
ACS580 18.02.2020 autobackup		▶
ACS580 27.11.2019		▶
ACS580 28.11.2019		▶
<b>Back</b>	16:09	<b>Select</b>

Local	ACS580	0.0 Hz
<b>ACS580 18.02.2020 autobackup</b> —		
View backup contents ▶		
Restore all		
Select par restore group ▶		
Select user sets ▶		
Select prod. data items ▶		
<b>Back</b>	16:09	<b>Select</b>

To go the **Backups** menu from the Home view, select **Menu - Backups**.

For backups and restores, see section [Backup and restore](#) on page 189.

## Options menu

Local	ACS580	0.0 Hz
Output frequency		0.00
Hz		
Motor current		0.00
A		
Motor torque		0.0
%		
<b>Options</b>	16:00	<b>Menu</b>

Local	ACS580	0.0 Hz
<b>Options</b> —		
Reference ▶		
Direction change		
Select drive ▶		
Edit Home view ▶		
Active faults		
<b>Exit</b>	16:00	<b>Select</b>

To go to the **Options** menu, press the **Options** softkey () in any of the Home view displays. The table below provides information about the different options available in the **Options** menu.

Menu item	Description
Reference	You can change the reference, which is visible on the top right corner of the panel displays.
Direction change	Alters the sign of active reference between positive and negative. Absolute value of reference is not changed.
Select drive	You can select a drive that you want to monitor or control from the list of drives showing the drives connected on the panel bus. You can also clear the list of drives.

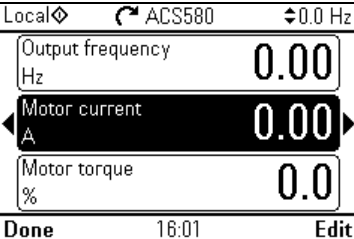
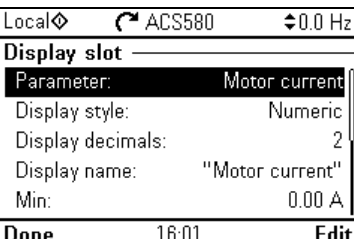
Menu item	Description
Edit Home view	<p>You can edit the Home view displays. Scroll with the arrow keys (◀) and (▶) to the Home view you want to edit. Select the display slot, that is, which of the current parameter(s) you want to edit (Home views show one to three parameters). Edit the parameter and how you want to display it.</p>  <p>Local ◊ ↻ ACS580 ⚡ 0.0 Hz</p> <p>Output frequency 0.00 Hz</p> <p>Motor current 0.00 A</p> <p>Motor torque 0.0 %</p> <p><b>Done</b> 16:01 <b>Edit</b></p>  <p>Local ◊ ↻ ACS580 ⚡ 0.0 Hz</p> <p><b>Display slot</b></p> <p>Parameter: Motor current</p> <p>Display style: Numeric</p> <p>Display decimals: 2</p> <p>Display name: "Motor current"</p> <p>Min: 0.00 A</p> <p><b>Done</b> 16:01 <b>Edit</b></p>
Active faults	Shows the active faults.
Active warnings	Shows the active warnings.
Active inhibits	Shows the active inhibits.



# Control macros

---

## Contents of this chapter

This chapter describes the intended use, operation and default control connections of the application. At the end of chapter there are tables showing those parameter default values that are not the same for all macros.

## General

Control macros are sets of default parameter values suitable for a certain control configuration. When starting up the drive, the user typically selects the best-suited control macro as a starting point, then makes any necessary changes to tailor the settings to their purpose. This usually results in a much lower number of user edits compared to the traditional way of programming a drive.

Control macros can be selected in the Primary settings menu: **Menu - Primary settings - Macro** or with parameter [96.04 Macro select](#) (page 417).

**Note:** All macros are made for scalar control except ABB standard which exists in two versions. If you want to use vector control, do as follows:

- Select the ABB standard (vector) macro.
- Check nominal values of the motor: **Menu - Primary settings - Motor - Nominal values**.
- Change motor control mode to vector: **Menu - Primary settings - Motor - Control mode**, and follow the instructions (see the figure on the right).

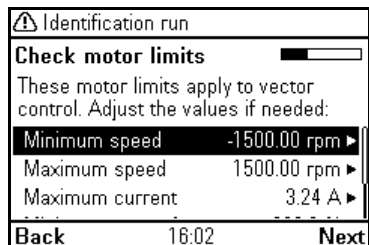

## ABB standard macro

This is the default macro. It provides a general purpose, 2-wire I/O configuration with three constant speeds. One signal is used to start or stop the motor and another to select the direction. The ABB standard macro uses scalar control; for vector control, use the ABB standard (vector) macro (page 80).

### Default control connections for the ABB standard macro

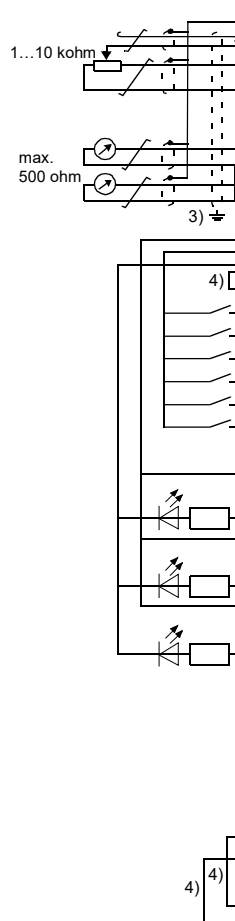

XI		Reference voltage and analog inputs and outputs	
1	SCR	Signal cable shield (screen)	
2	AI1	<b>Ext. frequency reference 1:</b> 0...10 V <sup>6)</sup>	
3	AGND	Analog input circuit common	
4	+10V	Reference voltage 10 V DC	
5	AI2	Not configured <sup>6)</sup>	
6	AGND	Analog input circuit common	
7	AO1	<b>Output frequency:</b> 0...20 mA <sup>6)</sup>	
8	AO2	<b>Motor current:</b> 0...20 mA	
9	AGND	Analog output circuit common	
X2 & X3		Aux. voltage output and programmable digital inputs	
10	+24V	Auxiliary voltage output +24 V DC, max. 250 mA	
11	DGND	Auxiliary voltage output common	
12	DCOM	Digital input common for all	
13	DI1	<b>Stop (0) / Start (1)</b>	
14	DI2	<b>Forward (0) / Reverse (1)</b>	
15	DI3	<b>Constant frequency selection<sup>1)</sup></b>	
16	DI4	<b>Constant frequency selection<sup>1)</sup></b>	
17	DI5	<b>Ramp set 1 (0) / Ramp set 2 (1)<sup>2)</sup></b>	
18	DI6	Not configured	
X6, X7, X8		Relay outputs	
19	RO1C	<b>Ready run</b>	250 V AC / 30 V DC
20	RO1A	2 A	
21	RO1B	<b>Running</b>	250 V AC / 30 V DC
22	RO2C	2 A	
23	RO2A	<b>Fault (-1)</b>	250 V AC / 30 V DC
24	RO2B	2 A	
25	RO3C		
26	RO3A		
27	RO3B		
X5		Embedded fieldbus	
29	B+	Embedded Modbus RTU (EIA-485). See chapter <a href="#">Fieldbus control through the embedded fieldbus interface (EFB)</a> on page 505.	
30	A-		
31	DGND		
S4	TERM	Serial data link termination switch	
S5	BIAS	Serial data link bias resistors switch	
X4		Safe torque off	
34	OUT1	Safe torque off. Factory connection. Both circuits must be closed for the drive to start. See chapter <a href="#">The Safe torque off function</a> in the <i>Hardware manual</i> of the drive.	
35	OUT2		
36	SGND		
37	IN1		
38	IN2		
X10		24 V AC/DC	
40	24 V AC/DC+ in	R6...R11 only: Ext. 24V AC/DC input to power up the control unit when the main supply is disconnected.	
41	24 V AC/DC- in		

See the notes on the next page.

Terminal sizes:

R1...R5: 0.2...2.5 mm<sup>2</sup> (terminals +24V, DGND, DCOM, B+, A-)

0.14...1.5 mm<sup>2</sup> (terminals DI, AI, AO, AGND, RO, STO)

R6...R11: 0.14...2.5 mm<sup>2</sup> (all terminals)

Tightening torques: 0.5...0.6 N·m (0.4 lbf·ft)

#### Notes:

- 1) See **Menu - Primary settings - Start, stop, reference - Constant frequencies** or parameter group [28 Frequency reference chain](#).

DI3	DI4	Operation/Parameter
0	0	Set frequency through AI1
1	0	<a href="#">28.26 Constant frequency 1</a>
0	1	<a href="#">28.27 Constant frequency 2</a>
1	1	<a href="#">28.28 Constant frequency 3</a>

- 2) See **Menu - Primary settings - Ramps** or parameter group [28 Frequency reference chain](#).

DI5	Ramp set	Parameters
0	1	<a href="#">28.72 Freq acceleration time 1</a> <a href="#">28.73 Freq deceleration time 1</a>
1	2	<a href="#">28.74 Freq acceleration time 2</a> <a href="#">28.75 Freq deceleration time 2</a>

- 3) Ground the outer shield of the cable 360 degrees under the grounding clamp on the grounding shelf for the control cables.
- 4) Connected with jumpers at the factory.
- 5) Only frames R6...R11 have terminals 40 and 41 for external 24 V AC/DC input.
- 6) Select voltage or current for inputs AI1 and AI2 and output AO1 with parameters [12.15](#), [12.25](#) and [13.15](#), respectively.

#### Input signals

- Analog frequency reference (AI1)
- Start/stop selection (DI1)
- Direction selection (DI2)
- Constant frequency selection (DI3, DI4)
- Ramp set (1 of 2) selection (DI5)

#### Output signals

- Analog output AO1: Output frequency
  - Analog output AO2: Motor current
  - Relay output 1: Ready run
  - Relay output 2: Running
  - Relay output 3: Fault (-1)
-

## ABB standard (vector) macro

The ABB standard (vector) uses vector control; otherwise it is similar to the ABB standard macro, providing a general purpose, 2-wire I/O configuration with three constant speeds. One signal is used to start or stop the motor and another to select the direction. To enable the macro, select it in the **Primary settings** menu or set parameter [96.04 Macro select to ABB standard \(vector\)](#).

### ■ Default control connections for the ABB standard (vector) macro

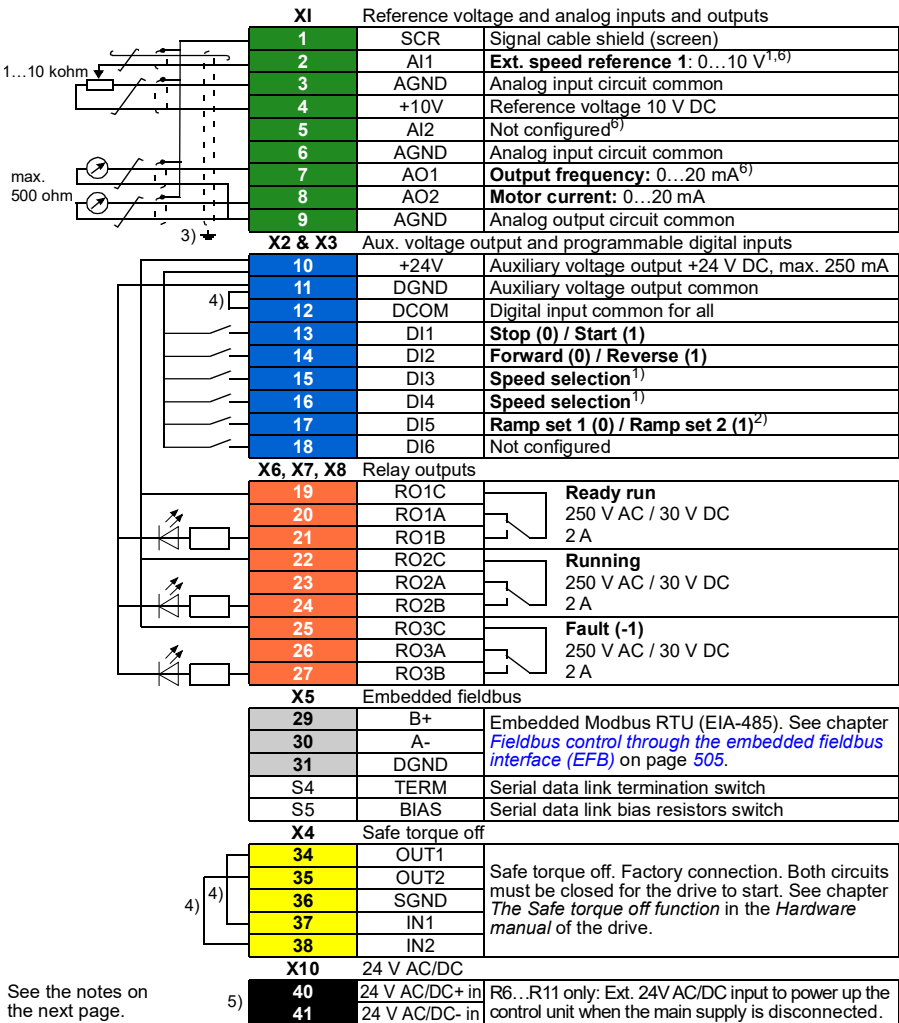



Terminal sizes:

- R1...R5: 0.2...2.5 mm<sup>2</sup> (terminals +24V, DGND, DCOM, B+, A-)  
 0.14...1.5 mm<sup>2</sup> (terminals DI, AI, AO, AGND, RO, STO)  
 R6...R11: 0.14...2.5 mm<sup>2</sup> (all terminals)

Tightening torques: 0.5...0.6 N·m (0.4 lbf·ft)

#### Notes:

- 1) See **Menu - Primary settings - Start, stop, reference - Constant speeds** or parameter group [22 Speed reference selection](#).

DI3	DI4	Operation/Parameter
0	0	Set speed through AI1
1	0	<a href="#">22.26 Constant speed 1</a>
0	1	<a href="#">22.27 Constant speed 2</a>
1	1	<a href="#">22.28 Constant speed 3</a>

- 2) See **Menu - Primary settings - Ramps** or parameter group [23 Speed reference ramp](#).

DI5	Ramp set	Parameters
0	1	<a href="#">23.12 Acceleration time 1</a> <a href="#">23.13 Deceleration time 1</a>
1	2	<a href="#">23.14 Acceleration time 2</a> <a href="#">23.15 Deceleration time 2</a>

- 3) Ground the outer shield of the cable 360 degrees under the grounding clamp on the grounding shelf for the control cables.
- 4) Connected with jumpers at the factory
- 5) Only frames R6...R11 have terminals 40 and 41 for external 24 V AC/DC input.
- 6) Select voltage or current for inputs AI1 and AI2 and output AO1 with parameters [12.15](#), [12.25](#) and [13.15](#), respectively.

#### Input signals

- Analog speed reference (AI1)
- Start/stop selection (DI1)
- Direction selection (DI2)
- Constant speed selection (DI3, DI4)
- Ramp set (1 of 2) selection (DI5)

#### Output signals

- Analog output AO1: Output frequency
  - Analog output AO2: Motor current
  - Relay output 1: Ready run
  - Relay output 2: Running
  - Relay output 3: Fault (-1)
-

## 3-wire macro

This macro is used when the drive is controlled using momentary push-buttons. It provides three constant speeds. To enable the macro, select it in the **Primary settings** menu or set parameter [96.04 Macro select](#) to **3-wire**.

### Default control connections for the 3-wire macro

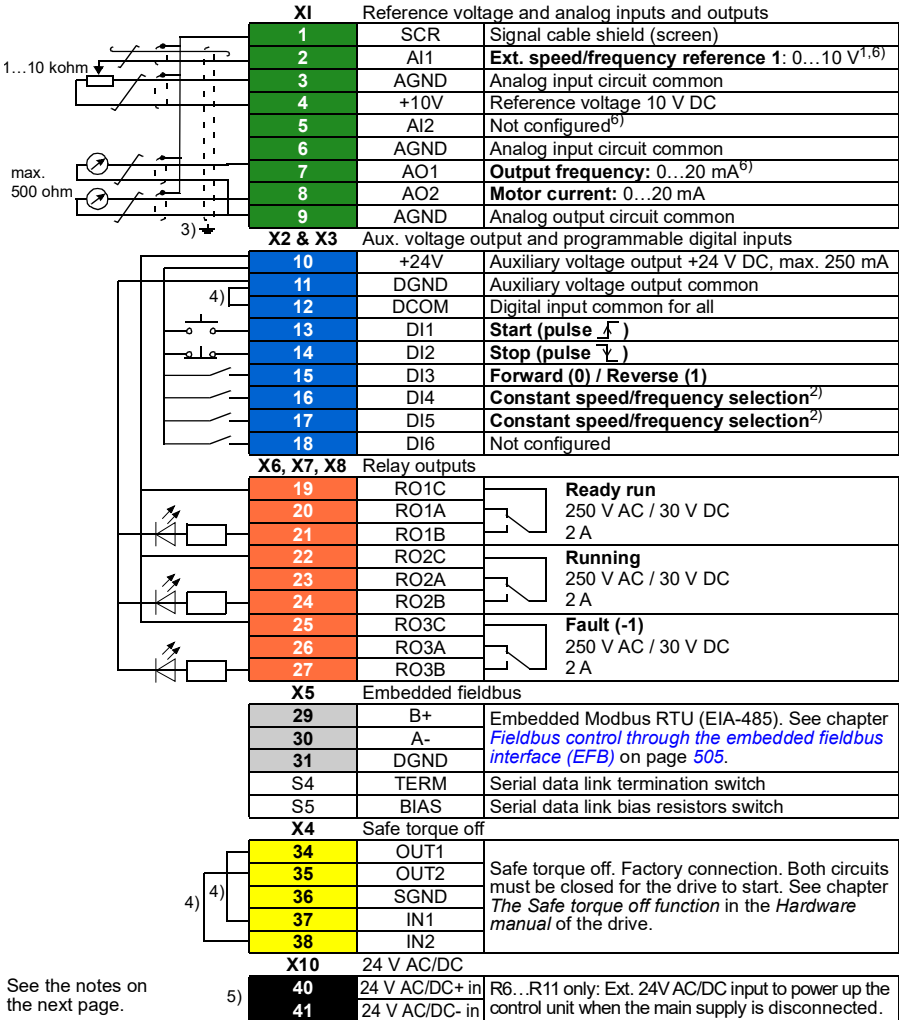

Terminal sizes:

- R1...R5: 0.2...2.5 mm<sup>2</sup> (terminals +24V, DGND, DCOM, B+, A-)  
 0.14...1.5 mm<sup>2</sup> (terminals DI, AI, AO, AGND, RO, STO)  
 R6...R11: 0.14...2.5 mm<sup>2</sup> (all terminals)

Tightening torques: 0.5...0.6 N·m (0.4 lbf·ft)

#### Notes:

- 1) AI1 is used as a speed reference if vector control is selected.
- 2) In scalar control (default): See **Menu - Primary settings - Start, stop, reference - Constant frequencies** or parameter group [28 Frequency reference chain](#).  
In vector control: See **Menu - Primary settings - Start, stop, reference - Constant speeds** or parameter group [22 Speed reference selection](#).

DI4	DI5	Operation/Parameter	
		Scalar control (default)	Vector control
0	0	Set frequency through AI1	Set speed through AI1
1	0	<a href="#">28.26 Constant frequency 1</a>	<a href="#">22.26 Constant speed 1</a>
0	1	<a href="#">28.27 Constant frequency 2</a>	<a href="#">22.27 Constant speed 2</a>
1	1	<a href="#">28.28 Constant frequency 3</a>	<a href="#">22.28 Constant speed 3</a>

- 3) Ground the outer shield of the cable 360 degrees under the grounding clamp on the grounding shelf for the control cables.
- 4) Connected with jumpers at the factory.
- 5) Only frames R6...R11 have terminals 40 and 41 for external 24 V AC/DC input.
- 6) Select voltage or current for inputs AI1 and AI2 and output AO1 with parameters [12.15](#), [12.25](#) and [13.15](#), respectively.

#### Input signals

- Analog speed/frequency reference (AI1)
- Start, pulse (DI1)
- Stop, pulse (DI2)
- Direction selection (DI3)
- Constant speed/frequency selection (DI4, DI5)

#### Output signals

- Analog output AO1: Output frequency
- Analog output AO2: Motor current
- Relay output 1: Ready run
- Relay output 2: Running
- Relay output 3: Fault (-1)

## Alternate macro

This macro provides an I/O configuration where one signal starts the motor in the forward direction and another signal to start the motor in the reverse direction. To enable the macro, select it in the **Primary settings** menu or set parameter **96.04 Macro select** to *Alternate*.

### Default control connections for the Alternate macro

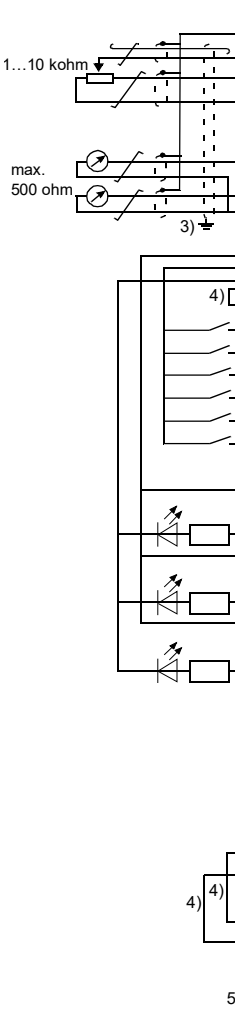

XI		Reference voltage and analog inputs and outputs	
1	SCR		Signal cable shield (screen)
2	AI1		<b>Ext. speed/frequency reference 1: 0...10 V<sup>6)</sup></b>
3	AGND		Analog input circuit common
4	+10V		Reference voltage 10 V DC
5	AI2		Not configured <sup>6)</sup>
6	AGND		Analog input circuit common
7	AO1		<b>Output frequency: 0...20 mA<sup>6)</sup></b>
8	AO2		<b>Motor current: 0...20 mA</b>
9	AGND		Analog output circuit common
X2 & X3		Aux. voltage output and programmable digital inputs	
10	+24V		Auxiliary voltage output +24 V DC, max. 250 mA
11	DGND		Auxiliary voltage output common
12	DCOM		Digital input common for all
13	DI1		<b>Start forward; if DI1 = DI2: Stop</b>
14	DI2		<b>Start reverse</b>
15	DI3		<b>Constant speed/frequency selection<sup>1)</sup></b>
16	DI4		<b>Constant speed/frequency selection<sup>1)</sup></b>
17	DI5		<b>Ramp set 1 (0) / Ramp set 2 (1)<sup>2)</sup></b>
18	DI6		<b>Run enable; if 0, drive stops</b>
X6, X7, X8		Relay outputs	
19	RO1C		<b>Ready run</b>
20	RO1A		250 V AC / 30 V DC
21	RO1B		<b>Running</b>
22	RO2C		250 V AC / 30 V DC
23	RO2A		<b>Fault (-1)</b>
24	RO2B		250 V AC / 30 V DC
25	RO3C		
26	RO3A		250 V AC / 30 V DC
27	RO3B		250 V AC / 30 V DC
X5		Embedded fieldbus	
29	B+		Embedded Modbus RTU (EIA-485). See chapter <a href="#">Fieldbus control through the embedded fieldbus interface (EFB)</a> on page 505.
30	A-		
31	DGND		
S4	TERM		Serial data link termination switch
S5	BIAS		Serial data link bias resistors switch
X4		Safe torque off	
34	OUT1		Safe torque off. Factory connection. Both circuits must be closed for the drive to start. See chapter <a href="#">The Safe torque off function</a> in the <i>Hardware manual</i> of the drive.
35	OUT2		
36	SGND		
37	IN1		
38	IN2		
X10		24 V AC/DC	
40	24 V AC/DC+ in		R6...R11 only: Ext. 24V AC/DC input to power up the control unit when the main supply is disconnected.
41	24 V AC/DC- in		

See the notes on the next page.

Terminal sizes:

- R1...R5: 0.2...2.5 mm<sup>2</sup> (terminals +24V, DGND, DCOM, B+, A-)  
 0.14...1.5 mm<sup>2</sup> (terminals DI, AI, AO, AGND, RO, STO)  
 R6...R11: 0.14...2.5 mm<sup>2</sup> (all terminals)

Tightening torques: 0.5...0.6 N·m (0.4 lbf·ft)

#### Notes:

- 1) In scalar control (default): See **Menu - Primary settings - Start, stop, reference - Constant frequencies** or parameter group [28 Frequency reference chain](#).

In vector control: See **Menu - Primary settings - Start, stop, reference - Constant speeds** or parameter group [22 Speed reference selection](#).

DI3	DI4	Operation/Parameter	
		Scalar control (default)	Vector control
0	0	Set frequency through AI1	Set speed through AI1
1	0	<a href="#">28.26 Constant frequency 1</a>	<a href="#">22.26 Constant speed 1</a>
0	1	<a href="#">28.27 Constant frequency 2</a>	<a href="#">22.27 Constant speed 2</a>
1	1	<a href="#">28.28 Constant frequency 3</a>	<a href="#">22.28 Constant speed 3</a>

- 2) In scalar control (default): See **Menu - Primary settings - Ramps** or parameter group [28 Frequency reference chain](#).

In vector control: See **Menu - Primary settings - Ramps** or parameter group [23 Speed reference ramp](#).

DI5	Ramp set	Parameters	
		Scalar control (default)	Vector control
0	1	<a href="#">28.72 Freq acceleration time 1</a>	<a href="#">23.12 Acceleration time 1</a>
		<a href="#">28.73 Freq deceleration time 1</a>	<a href="#">23.13 Deceleration time 1</a>
1	2	<a href="#">28.74 Freq acceleration time 2</a>	<a href="#">23.14 Acceleration time 2</a>
		<a href="#">28.75 Freq deceleration time 2</a>	<a href="#">23.15 Deceleration time 2</a>

- 3) Ground the outer shield of the cable 360 degrees under the grounding clamp on the grounding shelf for the control cables.
- 4) Connected with jumpers at the factory.
- 5) Only frames R6...R11 have terminals 40 and 41 for external 24 V AC/DC input.
- 6) Select voltage or current for inputs AI1 and AI2 and output AO1 with parameters [12.15](#), [12.25](#) and [13.15](#), respectively.

#### Input signals

- Analog speed/frequency reference (AI1)
- Start motor forward (DI1)
- Start motor in reverse (DI2)
- Constant speed/frequency selection (DI3, DI4)
- Ramp set (1 of 2) selection (DI5)
- Run enable (DI6)

#### Output signals

- Analog output AO1: Output frequency
- Analog output AO2: Motor current
- Relay output 1: Ready run
- Relay output 2: Running
- Relay output 3: Fault (-1)

## Motor potentiometer macro

This macro provides a way to adjust the speed with the help of two-push buttons, or a cost-effective interface for PLCs that vary the speed of the motor using only digital signals. To enable the macro, select it in the **Primary settings** menu or set parameter [96.04 Macro select](#) to *Motor potentiometer*.

### Default control connections for the Motor potentiometer macro

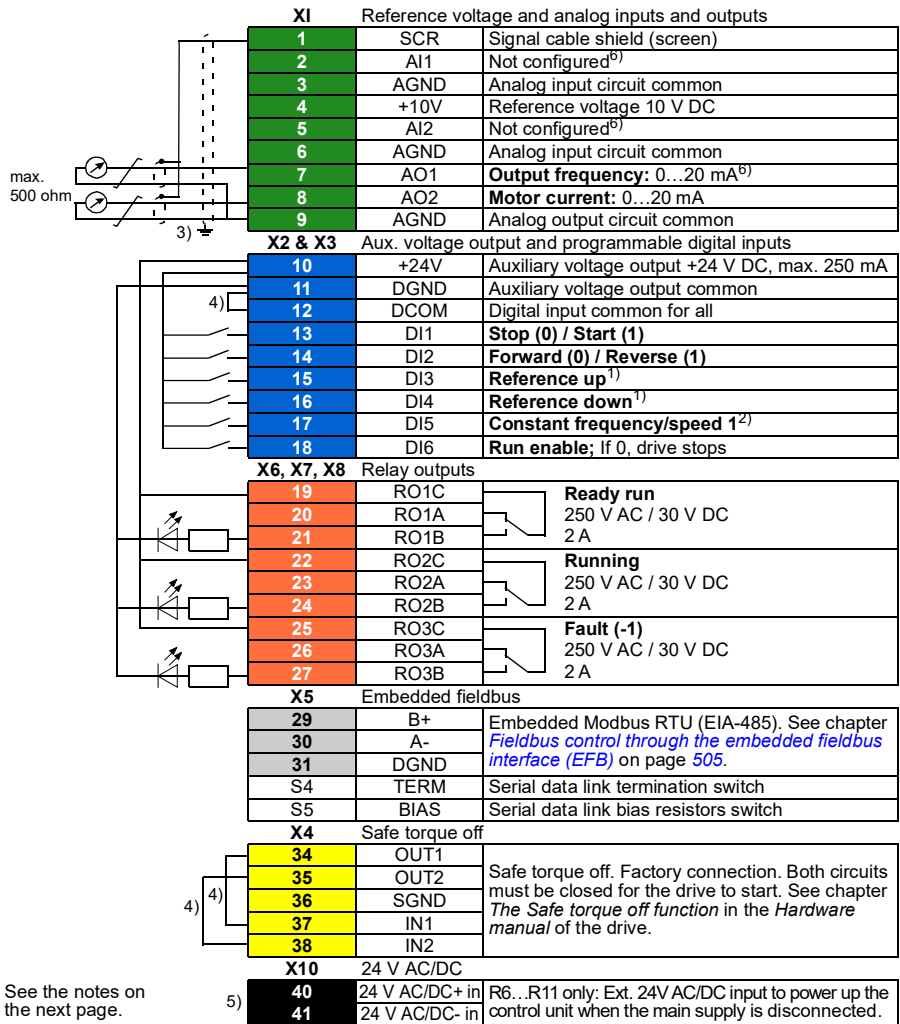

See the notes on the next page.

Terminal sizes:

R1...R5: 0.2...2.5 mm<sup>2</sup> (terminals +24V, DGND, DCOM, B+, A-)

0.14...1.5 mm<sup>2</sup> (terminals DI, AI, AO, AGND, RO, STO)

R6...R11: 0.14...2.5 mm<sup>2</sup> (all terminals)

Tightening torques: 0.5...0.6 N·m (0.4 lbf·ft)

#### Notes:

- 1) If DI3 and DI4 are both active or inactive, the frequency/speed reference is unchanged. The existing frequency/speed reference is stored during stop and power down.
- 2) In scalar control (default): See **Menu - Primary settings - Start, stop, reference - Constant frequencies** or parameter [28.26 Constant frequency 1](#).  
In vector control: See **Menu - Primary settings - Start, stop, reference - Constant speeds** or parameter [22.26 Constant speed 1](#).
- 3) Ground the outer shield of the cable 360 degrees under the grounding clamp on the grounding shelf for the control cables.
- 4) Connected with jumpers at the factory.
- 5) Only frames R6...R11 have terminals 40 and 41 for external 24 V AC/DC input.
- 6) Select voltage or current for inputs AI1 and AI2 and output AO1 with parameters [12.15](#), [12.25](#) and [13.15](#), respectively.

#### Input signals

- Start/Stop selection (DI1)
- Direction selection (DI2)
- Reference up (DI3)
- Reference down (DI4)
- Constant frequency/speed 1 (DI5)
- Run enable (DI6)

#### Output signals

- Analog output AO1: Output frequency
  - Analog output AO2: Motor current
  - Relay output 1: Ready run
  - Relay output 2: Running
  - Relay output 3: Fault (-1)
-

## Hand/Auto macro

This macro can be used when switching between two external control devices is needed. Both have their own control and reference signals. One signal is used to switch between these two. To enable the macro, select it in the **Primary settings** menu or set parameter [96.04 Macro select](#) to *Hand/Auto*.

### ■ Default control connections for the Hand/Auto macro

X1 Reference voltage and analog inputs and outputs		
1	SCR	Signal cable shield (screen)
2	AI1	<b>Ext. speed/freq. reference (Hand):</b> 0...10 V <sup>3)</sup>
3	AGND	Analog input circuit common
4	+10V	Reference voltage 10 V DC
5	AI2	<b>Ext. speed/freq. ref. (Auto):</b> 4...20 mA <sup>1,5)</sup>
6	AGND	Analog input circuit common
7	AO1	<b>Output frequency:</b> 0...20 mA <sup>5)</sup>
8	AO2	<b>Motor current:</b> 0...20 mA
9	AGND	Analog output circuit common

X2 & X3 Aux. voltage output and programmable digital inputs		
10	+24V	Auxiliary voltage output +24 V DC, max. 250 mA
11	DGND	Auxiliary voltage output common
12	DCOM	Digital input common for all
13	DI1	<b>Stop (0) / Start (1) (Hand)</b>
14	DI2	<b>Forward (0) / Reverse (1) (Hand)</b>
15	DI3	<b>Hand control (0) / Auto control (1)</b>
16	DI4	<b>Run enable;</b> if 0, drive stops
17	DI5	<b>Forward (0) / Reverse (1) (Auto)</b>
18	DI6	<b>Stop (0) / Start (1) (Auto)</b>

X6, X7, X8 Relay outputs		
19	RO1C	<b>Ready run</b> 250 V AC / 30 V DC 2 A
20	RO1A	
21	RO1B	
22	RO2C	<b>Running</b> 250 V AC / 30 V DC 2 A
23	RO2A	
24	RO2B	
25	RO3C	<b>Fault (-1)</b> 250 V AC / 30 V DC 2 A
26	RO3A	
27	RO3B	

X5 Embedded fieldbus		
29	B+	Embedded Modbus RTU (EIA-485). See chapter <a href="#">Fieldbus control through the embedded fieldbus interface (EFB)</a> on page 505.
30	A-	
31	DGND	
S4	TERM	Serial data link termination switch
S5	BIAS	Serial data link bias resistors switch

X4 Safe torque off		
34	OUT1	Safe torque off. Factory connection. Both circuits must be closed for the drive to start. See chapter <a href="#">The Safe torque off function</a> in the <i>Hardware manual</i> of the drive.
35	OUT2	
36	SGND	
37	IN1	
38	IN2	

X10 24 V AC/DC		
40	24 V AC/DC+ in	R6...R11 only: Ext. 24V AC/DC input to power up the control unit when the main supply is disconnected.
41	24 V AC/DC- in	

See the notes on the next page.



Terminal sizes:

R1...R5: 0.2...2.5 mm<sup>2</sup> (terminals +24V, DGND, DCOM, B+, A-)

0.14...1.5 mm<sup>2</sup> (terminals DI, AI, AO, AGND, RO, STO)

R6...R11: 0.14...2.5 mm<sup>2</sup> (all terminals)

Tightening torques: 0.5...0.6 N·m (0.4 lbf·ft)

#### Notes:

- 1) The signal source is powered externally. See the manufacturer's instructions. To use sensors supplied by the drive aux. voltage output, see chapter *Electrical installation*, section *Connection examples of two-wire and three-wire sensors* in the *Hardware manual* of the drive.
- 2) Ground the outer shield of the cable 360 degrees under the grounding clamp on the grounding shelf for the control cables.
- 3) Connected with jumpers at the factory.
- 4) Only frames R6...R11 have terminals 40 and 41 for external 24 V AC/DC input.
- 5) Select voltage or current for inputs AI1 and AI2 and output AO1 with parameters [12.15](#), [12.25](#) and [13.15](#), respectively.

#### Input signals

- Two speed/frequency analog references (AI1, AI2)
- Control location (Hand or Auto) selection (DI3)
- Start/stop selection, Hand (DI1)
- Direction selection, Hand (DI2)
- Start/stop selection, Auto (DI6)
- Direction selection, Auto (DI5)
- Run enable (DI4)

#### Output signals

- Analog output AO1: Output frequency
  - Analog output AO2: Motor current
  - Relay output 1: Ready run
  - Relay output 2: Running
  - Relay output 3: Fault (-1)
-

## Hand/PID macro

This macro controls the drive with the built-in process PID controller. In addition this macro has a second control location for the direct speed/frequency control mode. To enable the macro, select it in the **Primary settings** menu or set parameter [96.04 Macro select](#) to *Hand/PID*.

### ■ Default control connections for the Hand/PID macro

XI Reference voltage and analog inputs and outputs			
1	SCR	Signal cable shield (screen)	
2	AI1	<b>Ext. Hand reference or Ext. PID ref.:</b> 0...10 V <sup>1,7)</sup>	
3	AGND	Analog input circuit common	
4	+10V	Reference voltage 10 V DC	
5	AI2	<b>Actual PID feedback:</b> 4...20 mA <sup>2,7)</sup>	
6	AGND	Analog input circuit common	
7	AO1	<b>Output frequency:</b> 0...20 mA <sup>7)</sup>	
8	AO2	<b>Motor current:</b> 0...20 mA	
9	AGND	Analog output circuit common	
X2 & X3 Aux. voltage output and programmable digital inputs			
10	+24V	Auxiliary voltage output +24 V DC, max. 250 mA	
11	DGND	Auxiliary voltage output common	
12	DCOM	Digital input common for all	
13	DI1	<b>Stop (0) / Start (1) Hand</b>	
14	DI2	<b>Hand (0) / PID (1) selection</b>	
15	DI3	<b>Constant frequency selection<sup>3)</sup></b>	
16	DI4	<b>Constant frequency selection<sup>3)</sup></b>	
17	DI5	<b>Run enable;</b> if 0, drive stops	
18	DI6	<b>Stop (0) / Start (1) PID</b>	
X6, X7, X8 Relay outputs			
19	RO1C	<b>Ready run</b> 250 V AC / 30 V DC 2 A	
20	RO1A		
21	RO1B		
22	RO2C	<b>Running</b> 250 V AC / 30 V DC 2 A	
23	RO2A		
24	RO2B		
25	RO3C	<b>Fault (-1)</b> 250 V AC / 30 V DC 2 A	
26	RO3A		
27	RO3B		
X5 Embedded fieldbus			
29	B+	Embedded Modbus RTU (EIA-485). See chapter <a href="#">Fieldbus control through the embedded fieldbus interface (EFB)</a> on page 505.	
30	A-		
31	DGND		
S4	TERM	Serial data link termination switch	
S5	BIAS	Serial data link bias resistors switch	
X4 Safe torque off			
34	OUT1	Safe torque off. Factory connection. Both circuits must be closed for the drive to start. See chapter <a href="#">The Safe torque off function</a> in the <i>Hardware manual</i> of the drive.	
35	OUT2		
36	SGND		
37	IN1		
38	IN2		
X10 24 V AC/DC			
40	24 V AC/DC+ in	R6...R11 only: Ext. 24V AC/DC input to power up the control unit when the main supply is disconnected.	
41	24 V AC/DC- in		

See the notes on the next page.

Terminal sizes:

- R1...R5: 0.2...2.5 mm<sup>2</sup> (terminals +24V, DGND, DCOM, B+, A-)  
 0.14...1.5 mm<sup>2</sup> (terminals DI, AI, AO, AGND, RO, STO)  
 R6...R11: 0.14...2.5 mm<sup>2</sup> (all terminals)

Tightening torques: 0.5...0.6 N·m (0.4 lbf·ft)

#### Notes:

- 1) Hand: 0...10 V -> frequency reference.  
 PID: 0...10 V -> 0...100% PID setpoint.
- 2) The signal source is powered externally. See the manufacturer's instructions. To use sensors supplied by the drive aux. voltage output, see chapter *Electrical installation*, section *Connection examples of two-wire and three-wire sensors* in the *Hardware manual* of the drive.
- 3) In scalar control (default): See **Menu - Primary settings - Start, stop, reference - Constant frequencies** or parameter group [28 Frequency reference chain](#).

DI3	DI4	Operation (parameter)
		Scalar control (default)
0	0	Set frequency through AI1
1	0	<a href="#">28.26 Constant frequency 1</a>
0	1	<a href="#">28.27 Constant frequency 2</a>
1	1	<a href="#">28.28 Constant frequency 3</a>

- 4) Ground the outer shield of the cable 360 degrees under the grounding clamp on the grounding shelf for the control cables.
- 5) Connected with jumpers at the factory.
- 6) Only frames R6...R11 have terminals 40 and 41 for external 24 V AC/DC input.
- 7) Select voltage or current for inputs AI1 and AI2 and output AO1 with parameters [12.15](#), [12.25](#) and [13.15](#), respectively.

#### Input signals

- Analog reference (AI1)
- Actual feedback from PID (AI2)
- Control location (Hand or PID) selection (DI2)
- Start/stop selection, Hand (DI1)
- Start/stop selection, PID (DI6)
- Constant frequency selection (DI3, DI4)
- Run enable (DI5)

#### Output signals

- Analog output AO1: Output frequency
  - Analog output AO2: Motor current
  - Relay output 1: Ready run
  - Relay output 2: Running
  - Relay output 3: Fault (-1)
-

## PID macro

This macro is suitable for applications where the drive is always controlled by PID and the reference comes from analog input AI1. To enable the macro, select it in the **Primary settings** menu or set parameter [96.04 Macro select](#) to *PID*.

### ■ Default control connections for the PID macro

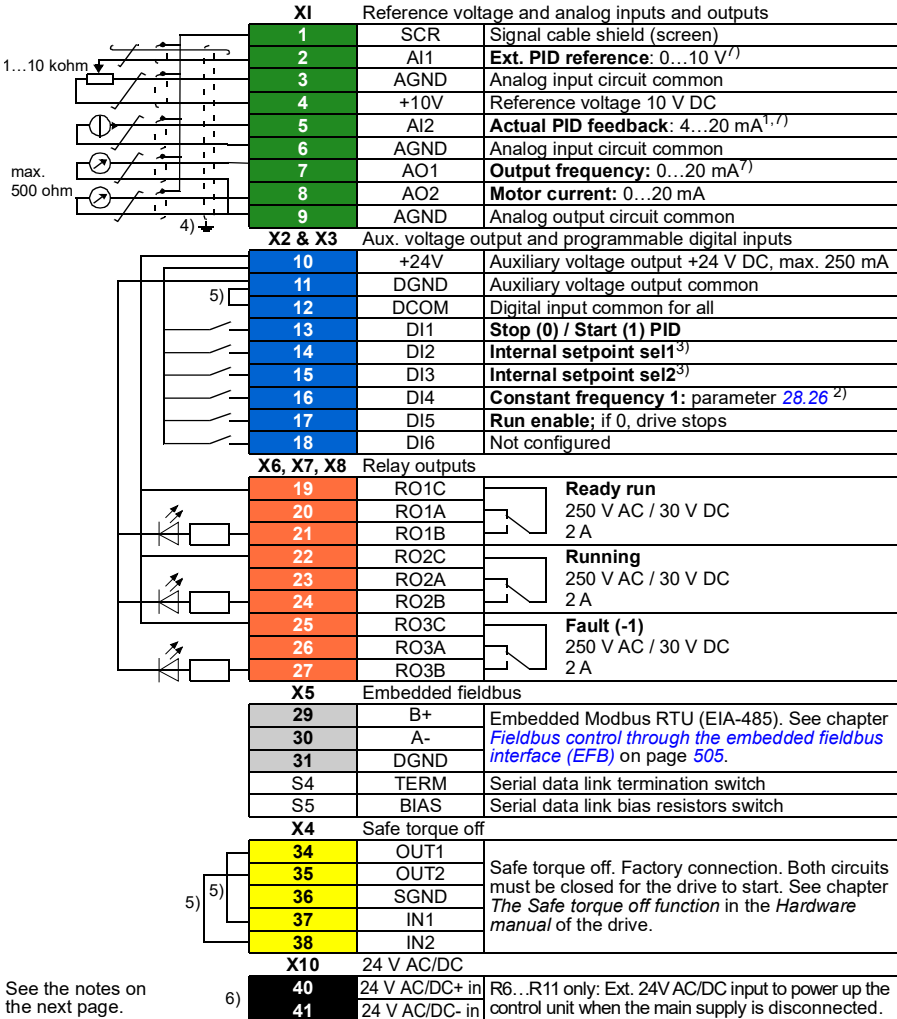

See the notes on the next page.

Terminal sizes:

R1...R5: 0.2...2.5 mm<sup>2</sup> (terminals +24V, DGND, DCOM, B+, A-)

0.14...1.5 mm<sup>2</sup> (terminals DI, AI, AO, AGND, RO, STO)

R6...R11: 0.14...2.5 mm<sup>2</sup> (all terminals)

Tightening torques: 0.5...0.6 N·m (0.4 lbf·ft)

### Notes:

- 1) The signal source is powered externally. See the manufacturer's instructions. To use sensors supplied by the drive aux. voltage output, see chapter *Electrical installation*, section *Connection examples of two-wire and three-wire sensors* in the *Hardware manual* of the drive.
- 2) If Constant frequency is activated it overrides the reference from the PID controller output.
- 3) See parameters [40.19 Set 1 internal setpoint sel1](#) and [40.20 Set 1 internal setpoint sel2](#) source table.

Source defined by par. <a href="#">40.19</a> <b>DI2</b>	Source defined by par. <a href="#">40.20</a> <b>DI3</b>	Internal setpoint active
0	0	Setpoint source: AI1 (par. <a href="#">40.16</a> )
1	0	1 (parameter <a href="#">40.21</a> )
0	1	2 (parameter <a href="#">40.22</a> )
1	1	3 (parameter <a href="#">40.23</a> )

- 4) Ground the outer shield of the cable 360 degrees under the grounding clamp on the grounding shelf for the control cables.
- 5) Connected with jumpers at the factory.
- 6) Only frames R6...R11 have terminals 40 and 41 for external 24 V AC/DC input.
- 7) Select voltage or current for inputs AI1 and AI2 and output AO1 with parameters [12.15](#), [12.25](#) and [13.15](#), respectively.

### Input signals

- Analog reference (AI1)
- Actual feedback from PID (AI2)
- Start/Stop selection, PID (DI1)
- Constant setpoint 1 (DI2)
- Constant setpoint 1 (DI3)
- Constant frequency 1 (DI4)
- Run enable (DI5)

### Output signals

- Analog output AO1: Output frequency
  - Analog output AO2: Motor current
  - Relay output 1: Ready run
  - Relay output 2: Running
  - Relay output 3: Fault (-1)
-

## Panel PID macro

This macro is suitable for applications where the drive is always controlled by PID and the setpoint is defined with the control panel. To enable the macro, select it in the **Primary settings** menu or set parameter *96.04 Macro select* to *Panel PID*.

### ■ Default control connections for the Panel PID macro

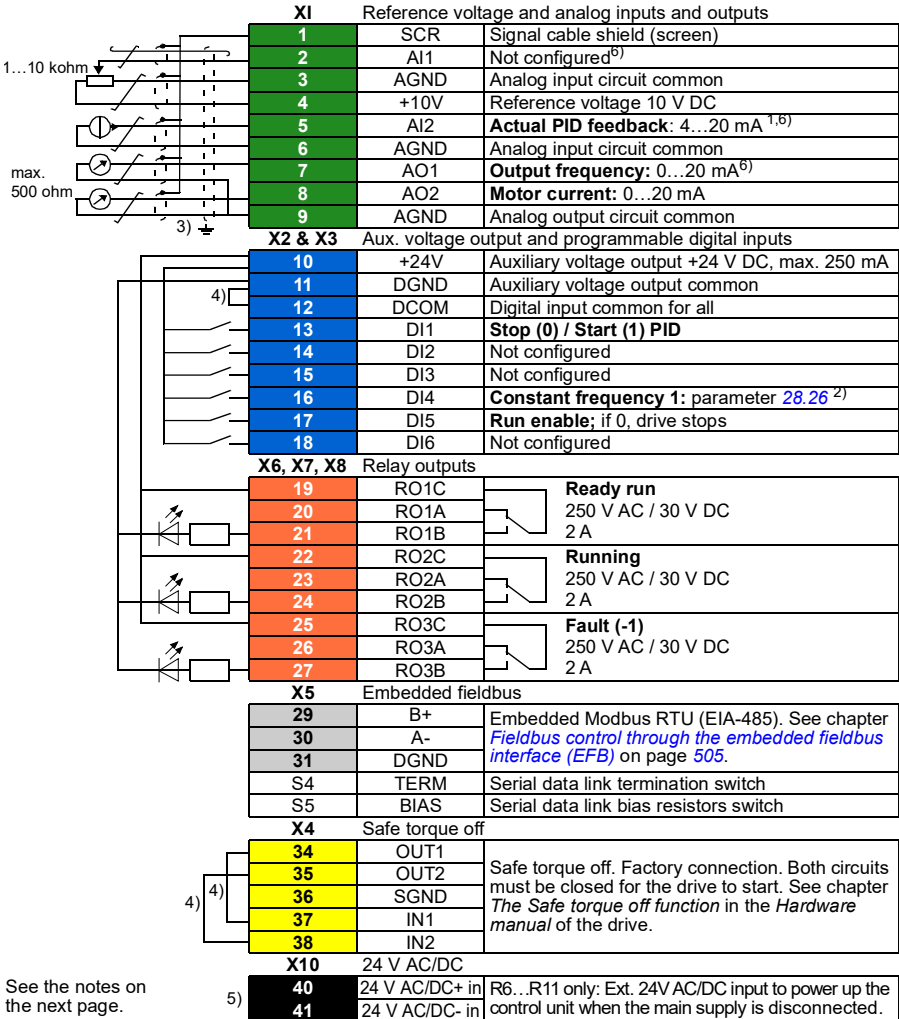

See the notes on the next page.

Terminal sizes:

R1...R5: 0.2...2.5 mm<sup>2</sup> (terminals +24V, DGND, DCOM, B+, A-)

0.14...1.5 mm<sup>2</sup> (terminals DI, AI, AO, AGND, RO, STO)

R6...R11: 0.14...2.5 mm<sup>2</sup> (all terminals)

Tightening torques: 0.5...0.6 N·m (0.4 lbf·ft)

#### Notes:

- 1) The signal source is powered externally. See the manufacturer's instructions. To use sensors supplied by the drive aux. voltage output, see chapter *Electrical installation*, section *Connection examples of two-wire and three-wire sensors* in the *Hardware manual* of the drive.
- 2) If Constant frequency is activated it overrides the reference from the PID controller output.
- 3) Ground the outer shield of the cable 360 degrees under the grounding clamp on the grounding shelf for the control cables.
- 4) Connected with jumpers at the factory.
- 5) Only frames R6...R11 have terminals 40 and 41 for external 24 V AC/DC input.
- 6) Select voltage or current for inputs AI1 and AI2 and output AO1 with parameters [12.15](#), [12.25](#) and [13.15](#), respectively.

#### Input signals

- PID setpoint given from the control panel
- Ext1 speed reference
- Torque reference (AI2)
- Start/Stop selection, PID (DI1)
- Constant frequency 1 (DI4)
- Run enable (DI5)

#### Output signals

- Analog output AO1: Motor speed
  - Analog output AO2: Motor current
  - Relay output 1: Ready run
  - Relay output 2: Running
  - Relay output 3: Fault (-1)
-

## PFC macro

Pump and fan control logic for controlling multiple pumps or fans through the drive's relay outputs. To enable the macro, select it in the **Primary settings** menu or set parameter [96.04 Macro select](#) to *PFC*.

### Default control connections for the PFC macro

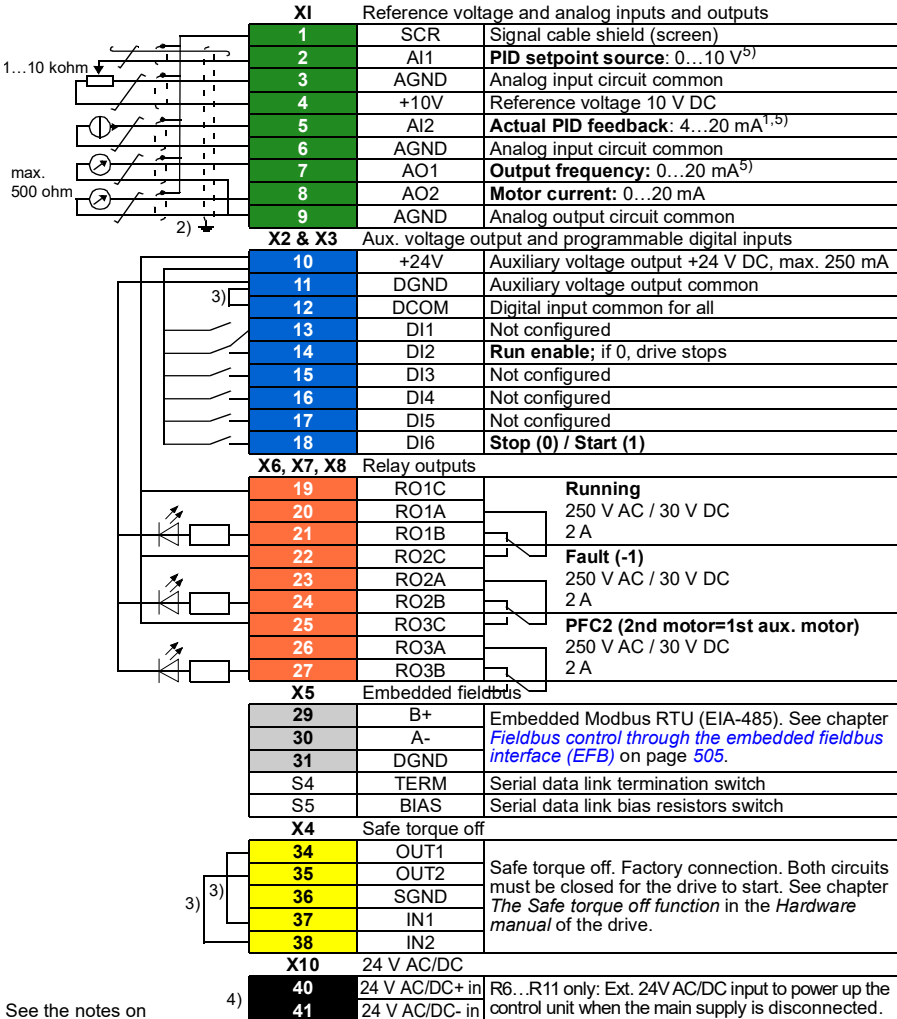

See the notes on the next page.



Terminal sizes:

R1...R5: 0.2...2.5 mm<sup>2</sup> (terminals +24V, DGND, DCOM, B+, A-)

0.14...1.5 mm<sup>2</sup> (terminals DI, AI, AO, AGND, RO, STO)

R6...R11: 0.14...2.5 mm<sup>2</sup> (all terminals)

Tightening torques: 0.5...0.6 N·m (0.4 lbf·ft)

#### Notes:

- 1) The signal source is powered externally. See the manufacturer's instructions. To use sensors supplied by the drive aux. voltage output, see chapter *Electrical installation*, section *Connection examples of two-wire and three-wire sensors* in the *Hardware manual* of the drive.
- 2) Ground the outer shield of the cable 360 degrees under the grounding clamp on the grounding shelf for the control cables.
- 3) Connected with jumpers at the factory.
- 4) Only frames R6...R11 have terminals 40 and 41 for external 24 V AC/DC input.
- 5) Select voltage or current for inputs AI1 and AI2 and output AO1 with parameters [12.15](#), [12.25](#) and [13.15](#), respectively.

#### Input signals

- Setpoint for PID (AI1)
- Actual feedback from PID (AI2)
- Run enable (DI2)
- Start/Stop selection (DI6)

#### Output signals

- Analog output AO1: Output frequency
  - Analog output AO2: Motor current
  - Relay output 1: Running
  - Relay output 2: Fault (-1)
  - Relay output 3: PFC2 (first PFC auxiliary motor)
-

## Torque control macro

This macro is used in applications in which torque control of the motor is required. These are typically tension applications, where a particular tension needs to be maintained in the mechanical system. To enable the macro, select it in the **Primary settings** menu (not yet there) or set parameter **96.04 Macro select** to *Torque control*.

### Default control connections for the Torque control macro

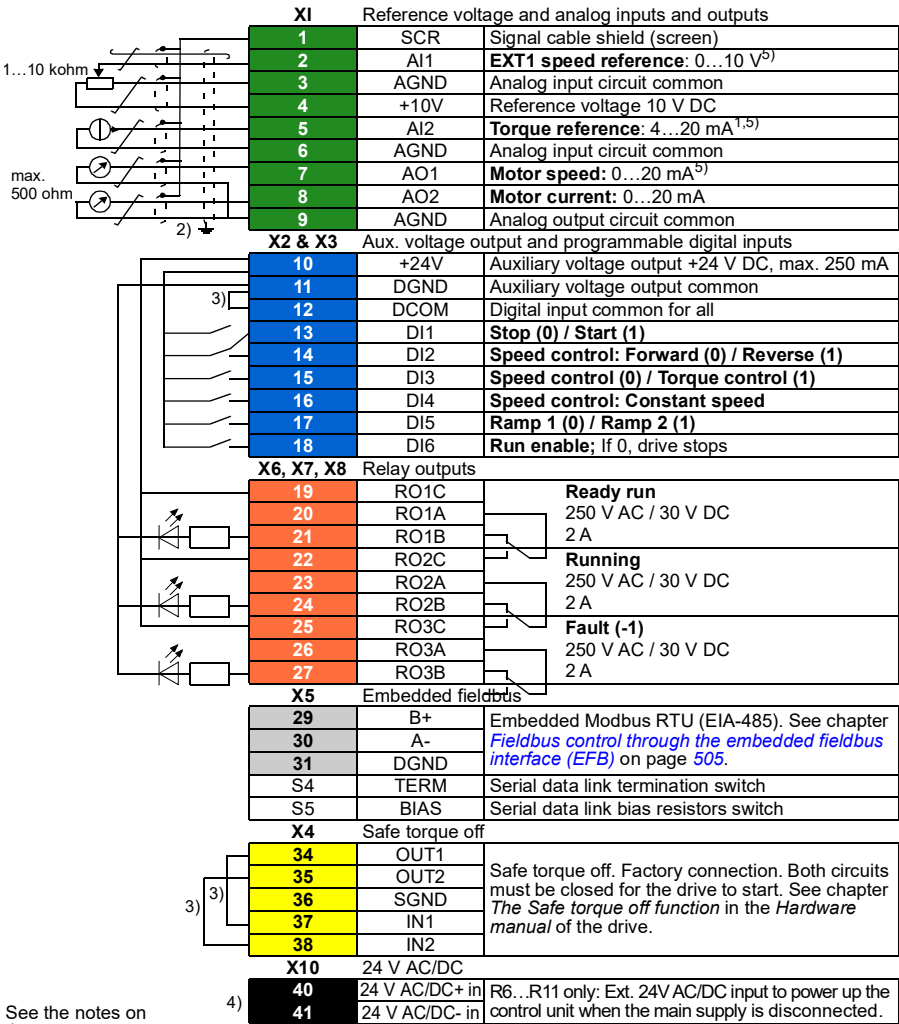

Terminal sizes:

R1...R5: 0.2...2.5 mm<sup>2</sup> (terminals +24V, DGND, DCOM, B+, A-)

0.14...1.5 mm<sup>2</sup> (terminals DI, AI, AO, AGND, RO, STO)

R6...R11: 0.14...2.5 mm<sup>2</sup> (all terminals)

Tightening torques: 0.5...0.6 N·m (0.4 lbf·ft)

#### Notes:

- 1) The signal source is powered externally. See the manufacturer's instructions. To use sensors supplied by the drive aux. voltage output, see chapter *Electrical installation*, section *Connection examples of two-wire and three-wire sensors* in the *Hardware manual* of the drive.
- 2) Ground the outer shield of the cable 360 degrees under the grounding clamp on the grounding shelf for the control cables.
- 3) Connected with jumpers at the factory.
- 4) Only frames R6...R11 have terminals 40 and 41 for external 24 V AC/DC input.
- 5) Select voltage or current for inputs AI1 and AI2 and output AO1 with parameters [12.15](#), [12.25](#) and [13.15](#), respectively.

#### Input signals

- Ext1 speed reference (AI1)
- Torque reference (AI2)
- Start/Stop selection (DI1)
- In speed control: Forward/ Reverse selection (DI2)
- Speed control / Torque control selection (DI3)
- In speed control: Constant speed (DI4)
- Ramp 1 / Ramp 2 selection (DI5)
- Run enable (DI6)

#### Output signals

- Analog output AO1: Motor speed
  - Analog output AO2: Motor current
  - Relay output 1: Ready run
  - Relay output 2: Running
  - Relay output 3: Fault (-1)
-

## Parameter default values for different macros

Chapter [Parameters](#) on page 195 shows the default values of all parameters for the ABB standard macro (factory macro). Some parameters have different default values for other macros. The tables below lists the default values for those parameter for each macro.

96.04 Macro select	1 = ABB standard	17 = ABB standard (vector)	11 = 3-wire	12 = Alternate	13 = Motor potentiometer
10.24 RO1 source	2 = Ready run	2 = Ready run	2 = Ready run	2 = Ready run	2 = Ready run
10.27 RO2 source	7 = Running	7 = Running	7 = Running	7 = Running	7 = Running
10.30 RO3 source	15 = Fault (-1)	15 = Fault (-1)	15 = Fault (-1)	15 = Fault (-1)	15 = Fault (-1)
12.20 AI1 scaled at AI1 max	50.000	1500.000	50.000	50.000	50.000
13.12 AO1 source	2 = Output frequency	1 = Motor speed used	2 = Output frequency	2 = Output frequency	2 = Output frequency
13.18 AO1 source max	50.0	1500.0	50.0	50.0	50.0
19.11 Ext1/Ext2 selection	0 = EXT1	0 = EXT1	0 = EXT1	0 = EXT1	0 = EXT1
20.01 Ext1 commands	2 = In1 Start; In2 Dir	2 = In1 Start; In2 Dir	5 = In1P Start; In2 Stop; In3 Dir	3 = In1 Startfwd; In2 Start rev	2 = In1 Start; In2 Dir
20.03 Ext1 in1 source	2 = DI1	2 = DI1	2 = DI1	2 = DI1	2 = DI1
20.04 Ext1 in2 source	3 = DI2	3 = DI2	3 = DI2	3 = DI2	3 = DI2
20.05 Ext1 in3 source	0 = Always off	0 = Always off	4 = DI3	0 = Always off	0 = Always off
20.06 Ext2 commands	0 = Not selected	0 = Not selected	0 = Not selected	0 = Not selected	0 = Not selected
20.08 Ext2 in1 source	0 = Always off	0 = Always off	0 = Always off	0 = Always off	0 = Always off
20.09 Ext2 in2 source	0 = Always off	0 = Always off	0 = Always off	0 = Always off	0 = Always off
20.12 Run enable 1 source	1 = Selected	1 = Selected	1 = Selected	7 = DI6	7 = DI6
22.11 Ext1 speed ref1	1 = AI1 scaled	1 = AI1 scaled	1 = AI1 scaled	1 = AI1 scaled	15 = Motor potentiometer
22.18 Ext2 speed ref1	0 = Zero	0 = Zero	0 = Zero	0 = Zero	0 = Zero
22.22 Constant speed sel1	4 = DI3	4 = DI3	5 = DI4	4 = DI3	6 = DI5
22.23 Constant speed sel2	5 = DI4	5 = DI4	6 = DI5	5 = DI4	0 = Always off

<b>96.04 Macro select</b>	<b>2 = Hand/Auto</b>	<b>3 = Hand/PID</b>	<b>14 = PID</b>	<b>15 = Panel PID</b>	<b>16 = PFC</b>
10.24 RO1 source	2 = Ready run	2 = Ready run	2 = Ready run	2 = Ready run	7 = Running
10.27 RO2 source	7 = Running	7 = Running	7 = Running	7 = Running	15 = Fault (-1)
10.30 RO3 source	15 = Fault (-1)	15 = Fault (-1)	15 = Fault (-1)	15 = Fault (-1)	46 = PFC2
12.20 AI1 scaled at AI1 max	50.000	50.000	50.000	50.000	50.000
13.12 AO1 source	2 = Output frequency	2 = Output frequency	2 = Output frequency	2 = Output frequency	2 = Output frequency
13.18 AO1 source max	50.0	50.0	50.0	50.0	50.0
19.11 Ext1/Ext2 selection	5 = DI3	4 = DI2	0 = EXT1	0 = EXT1	5 = DI3
20.01 Ext1 commands	2 = In1 Start; In2 Dir	1 = In1 Start	1 = In1 Start	1 = In1 Start	1 = In1 Start
20.03 Ext1 in1 source	2 = DI1	2 = DI1	2 = DI1	2 = DI1	2 = DI1
20.04 Ext1 in2 source	3 = DI2	0 = Always off	0 = Always off	0 = Always off	0 = Always off
20.05 Ext1 in3 source	0 = Always off	0 = Always off	0 = Always off	0 = Always off	0 = Always off
20.06 Ext2 commands	2 = In1 Start; In2 Dir	1 = In1 Start	0 = Not selected	0 = Not selected	1 = In1 Start
20.08 Ext2 in1 source	7 = DI6	7 = DI6	0 = Always off	0 = Always off	7 = DI6
20.09 Ext2 in2 source	6 = DI5	0 = Always off	0 = Always off	0 = Always off	0 = Always off
20.12 Run enable 1 source	5 = DI4	6 = DI5	6 = DI5	6 = DI5	3 = DI2
22.11 Ext1 speed ref1	1 = AI1 scaled	1 = AI1 scaled	16 = PID	16 = PID	1 = AI1 scaled
22.18 Ext2 speed ref1	2 = AI2 scaled	16 = PID	0 = Zero	0 = Zero	16 = PID
22.22 Constant speed sel1	0 = Always off	4 = DI3	5 = DI4	5 = DI4	0 = Always off
22.23 Constant speed sel2	0 = Always off	5 = DI4	0 = Always off	0 = Always off	0 = Always off

<b>96.04 Macro select</b>	<b>28 = Torque control</b>
10.24 RO1 source	7 = Ready run
10.27 RO2 source	15 = Running
10.30 RO3 source	46 = Fault (-1)
12.20 AI1 scaled at AI1 max	50.000
13.12 AO1 source	1 = Motor speed used
13.18 AO1 source max	50.0
19.11 Ext1/Ext2 selection	5 = DI3
19.14 Ext2 control mode	3 = Torque
20.01 Ext1 commands	2 = In1 Start; In2 Dir
20.03 Ext1 in1 source	2 = DI1
20.04 Ext1 in2 source	3 = DI2
20.05 Ext1 in3 source	0 = Always off
20.06 Ext2 commands	1 = In1 Start
20.08 Ext2 in1 source	2 = DI1
20.09 Ext2 in2 source	3 = DI2
20.12 Run enable 1 source	7 = DI6
22.11 Ext1 speed ref1	1 = AI1 scaled
22.18 Ext2 speed ref1	2 = AI2 scaled
22.21 Constant speed function	Bit 0 Constant speed = Separate, Bit 1 Direction enable = Accord
22.22 Constant speed sel1	5 = DI4
22.23 Constant speed sel2	0 = Always off

<b>96.04 Macro select</b>	<b>1 = ABB standard</b>	<b>17 = ABB stan- dard (vector)</b>	<b>11 = 3-wire</b>	<b>12 = Alternate</b>	<b>13 = Motor potenti- ometer</b>
22.71 Motor potentiometer function	0 = Disabled	0 = Disabled	0 = Disabled	0 = Disabled	1 = Enabled (init at stop /power-up)
22.73 Motor potentiometer up source	0 = Not used	0 = Not used	0 = Not used	0 = Not used	4 = DI3
22.74 Motor potentiometer down source	0 = Not used	0 = Not used	0 = Not used	0 = Not used	5 = DI4
23.11 Ramp set selection	6 = DI5	6 = DI5	0 = Acc/Dec time 1	6 = DI5	0 = Acc/Dec time 1
28.11 Ext1 frequency ref1	1 = AI1 scaled	1 = AI1 scaled	1 = AI1 scaled	1 = AI1 scaled	15 = Motor potentiometer
28.15 Ext1 frequency ref2	0 = Zero	0 = Zero	0 = Zero	0 = Zero	0 = Zero
28.22 Constant frequency sel1	4 = DI3	4 = DI3	5 = DI4	4 = DI3	6 = DI5
28.23 Constant frequency sel2	5 = DI4	5 = DI4	6 = DI5	5 = DI4	0 = Always off
28.71 Freq ramp set selection	6 = DI5	6 = DI5	0 = Acc/Dec time 1	6 = DI5	0 = Acc/Dec time 1
40.07 Process PID operation mode	0 = Off	0 = Off	0 = Off	0 = Off	0 = Off
40.16 Set 1 setpoint 1 source	11 = AI1 percent	11 = AI1 percent	11 = AI1 percent	11 = AI1 percent	11 = AI1 percent
40.17 Set 1 setpoint 2 source	0 = Not selected	0 = Not selected	0 = Not selected	0 = Not selected	0 = Not selected
40.19 Set 1 internal setpoint sel1	0 = Not selected	0 = Not selected	0 = Not selected	0 = Not selected	0 = Not selected
40.20 Set 1 internal setpoint sel2	0 = Not selected	0 = Not selected	0 = Not selected	0 = Not selected	0 = Not selected
40.32 Set 1 gain	1.00	1.00	1.00	1.00	1.00
40.33 Set 1 integration time	60.0	60.0	60.0	60.0	60.0
76.21 Multipump configuration	0 = Off	0 = Off	0 = Off	0 = Off	0 = Off
76.25 Number of motors	1	1	1	1	1
76.27 Max number of motors allowed	1	1	1	1	1
99.04 Motor control mode	1 = Scalar	0 = Vector	1 = Scalar	1 = Scalar	1 = Scalar

<b>96.04 Macro select</b>	<b>2 = Hand/Auto</b>	<b>3 = Hand/PID</b>	<b>14 = PID</b>	<b>15 = Panel PID</b>	<b>16 = PFC</b>
22.71 Motor potentiometer function	0 = Disabled	0 = Disabled	0 = Disabled	0 = Disabled	0 = Disabled
22.73 Motor potentiometer up source	0 = Not used	0 = Not used	0 = Not used	0 = Not used	0 = Not used
22.74 Motor potentiometer down source	0 = Not used	0 = Not used	0 = Not used	0 = Not used	0 = Not used
23.11 Ramp set selection	0 = Acc/Dec time 1	0 = Acc/Dec time 1	0 = Acc/Dec time 1	0 = Acc/Dec time 1	0 = Acc/Dec time 1
28.11 Ext1 frequency ref1	1 = AI1 scaled	1 = AI1 scaled	16 = PID	16 = PID	1 = AI1 scaled
28.15 Ext1 frequency ref2	2 = AI2 scaled	16 = PID	0 = Zero	0 = Zero	16 = PID
28.22 Constant frequency sel1	0 = Always off	4 = DI3	5 = DI4	5 = DI4	0 = Always off
28.23 Constant frequency sel2	0 = Always off	5 = DI4	0 = Always off	0 = Always off	0 = Always off
28.71 Freq ramp set selection	0 = Acc/Dec time 1	0 = Acc/Dec time 1	0 = Acc/Dec time 1	0 = Acc/Dec time 1	0 = Acc/Dec time 1
40.07 Process PID operation mode	0 = Off	2 = On when drive running	2 = On when drive running	2 = On when drive running	2 = On when drive running
40.16 Set 1 setpoint 1 source	11 = AI1 percent	11 = AI1 percent	11 = AI1 percent	13 = Control panel (ref)	11 = AI1 percent
40.17 Set 1 setpoint 2 source	0 = Not selected	0 = Not selected	2 = Internal setpoint	0 = Not selected	0 = Not selected
40.19 Set 1 internal setpoint sel1	0 = Not selected	0 = Not selected	3 = DI2	0 = Not selected	0 = Not selected
40.20 Set 1 internal setpoint sel2	0 = Not selected	0 = Not selected	4 = DI3	0 = Not selected	0 = Not selected
40.32 Set 1 gain	1.00	1.00	1.00	1.00	2.50
40.33 Set 1 integration time	60.0	60.0	60.0	60.0	3.0
76.21 Multipump configuration	0 = Off	0 = Off	0 = Off	0 = Off	2 = PFC
76.25 Number of motors	1	1	1	1	2
76.27 Max number of motors allowed	1	1	1	1	2
99.04 Motor control mode	1 = Scalar	1 = Scalar	1 = Scalar	1 = Scalar	1 = Scalar



<b>96.04 Macro select</b>	<b>28 = Torque control</b>
22.71 Motor potentiometer function	0 = Disabled
22.73 Motor potentiometer up source	0 = Not used
22.74 Motor potentiometer down source	0 = Not used
23.11 Ramp set selection	6 = DI5
26.11 Torque ref1 source	2 = AI2 scaled
28.11 Ext1 frequency ref1	1 = AI1 scaled
28.15 Ext1 frequency ref2	2 = AI2 scaled
28.22 Constant frequency sel1	5 = DI4
28.23 Constant frequency sel2	0 = Always off
28.71 Freq ramp set selection	6 = DI5
40.07 Process PID operation mode	0 = Off
40.16 Set 1 setpoint 1 source	11 = AI1 percent
40.17 Set 1 setpoint 2 source	0 = Not selected
40.19 Set 1 internal setpoint sel1	0 = Not selected
40.20 Set 1 internal setpoint sel2	0 = Not selected
40.32 Set 1 gain	1.00
40.33 Set 1 integration time	60.0
76.21 Multipump configuration	0 = Off
76.25 Number of motors	1
76.27 Max number of motors allowed	1
99.04 Motor control mode	0 = Vector

---





# Program features

---

## What this chapter contains

This chapter describes some of the more important functions within the control program, how to use them and how to program them to operate. It also explains the control locations and operating modes.

## Local control vs. external control

The ACS580 has two main control locations: external and local. The control location is selected with the Loc/Rem key on the control panel or in the PC tool.

---

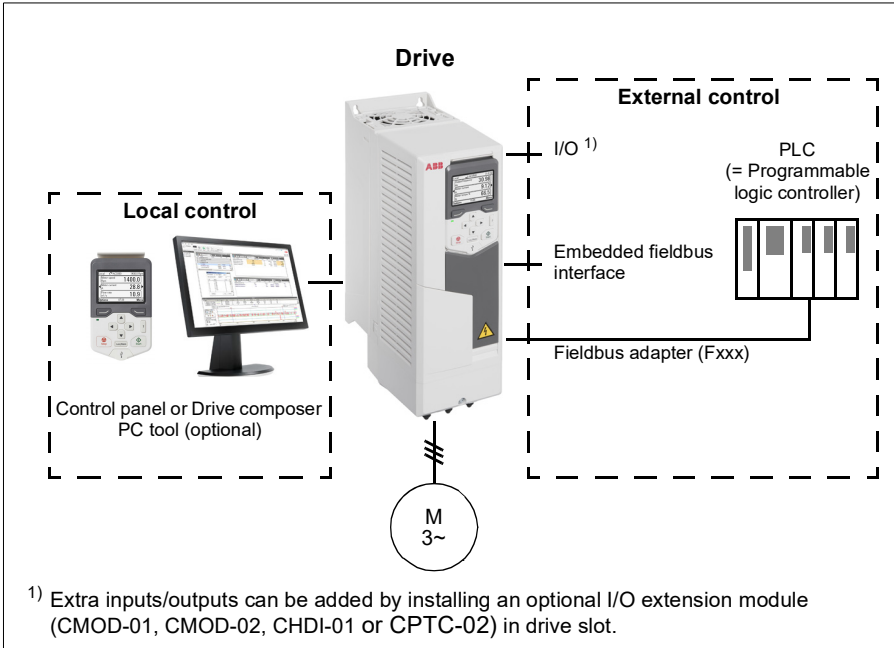

## Local control

The control commands are given from the control panel keypad or from a PC equipped with Drive composer when the drive is in local control. Speed and torque control modes are available in vector motor control mode; frequency mode is available when scalar motor control mode is used (see parameter [19.16](#)).

Local control is mainly used during commissioning and maintenance. The control panel always overrides the external control signal sources when used in local control. Changing the control location to local can be prevented by parameter [19.17](#).

The user can select by a parameter ([49.05](#)) how the drive reacts to a control panel or PC tool communication break. (The parameter has no effect in external control.)

### Settings and diagnostics

Parameters: [19.16 Local control mode](#)...[19.17 Local control disable](#) (page [246](#)) and [49.05 Communication loss action](#) (page [384](#)).

Events: -

## ■ External control

When the drive is in external (remote) control, control commands are given through

- the I/O terminals (digital and analog inputs), or optional I/O extension modules
- the fieldbus interface (via the embedded fieldbus interface or an optional fieldbus adapter module).

Two external control locations, EXT1 and EXT2, are available. The user can select the sources of the start and stop commands separately for each location in the Primary settings menu (**Menu - Primary settings - Start, stop, reference**) or by setting parameters [20.01](#)...[20.10](#). The operating mode can be selected separately for each location, which enables quick switching between different operating modes, for example speed and torque control. Selection between EXT1 and EXT2 is done via any binary source such as a digital input or fieldbus control word (**Menu - Primary settings - Start, stop, reference - Secondary control location** or parameter [19.11](#)). The source of reference is selectable for each operating mode separately.

### Settings and diagnostics

Parameters: [20.01 Ext1 commands](#)...[20.10 Ext2 in3 source](#) (page [247](#)), and [19.11 Ext1/Ext2 selection](#) (page [245](#)).

Events: -

### **Communication fail functionality**

The communication fail functionality ensures continuous process without interruptions. If there is a communication loss, the drive automatically changes the control location from EXT1 to EXT2. This enables process to be controlled, for example, with the drive PID controller. When the original control location recovers, the drive automatically switches control back to the communication network (EXT1).

---

**Block diagram: EXT1/EXT2 selection for speed control**

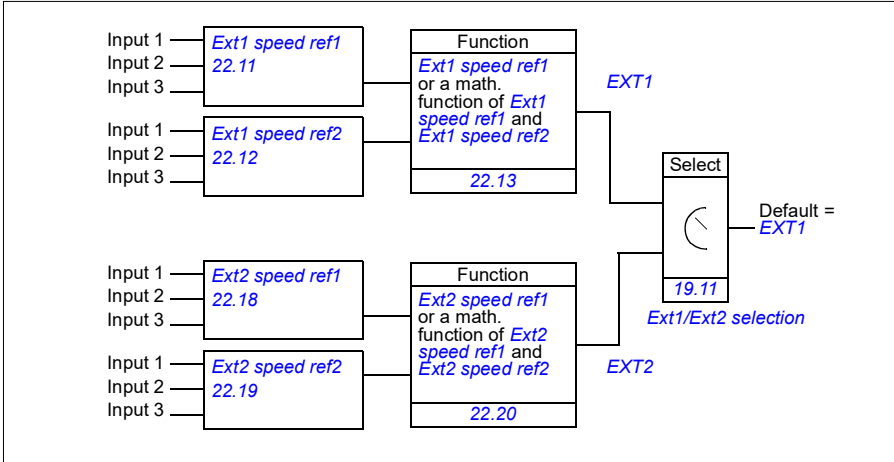

**Block diagram: EXT1/EXT2 selection for frequency control**

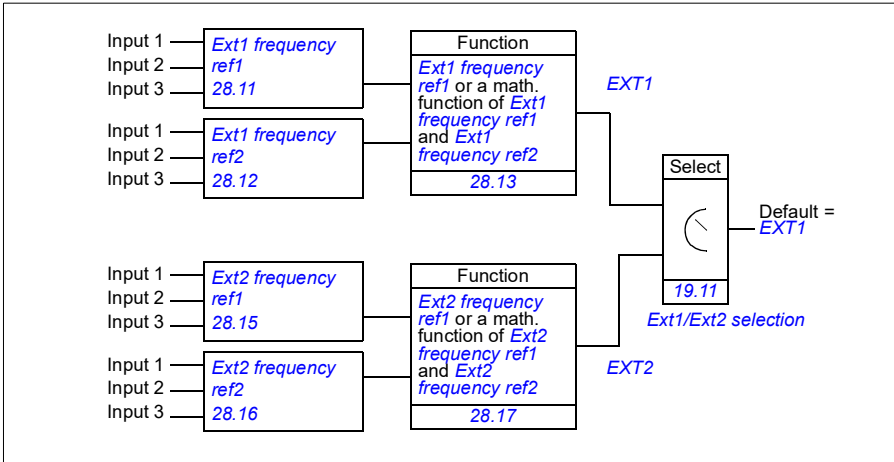

**Block diagram: Run enable source for EXT1**

The figure below shows the parameters that select the interface for run enable for external control location *EXT1*.

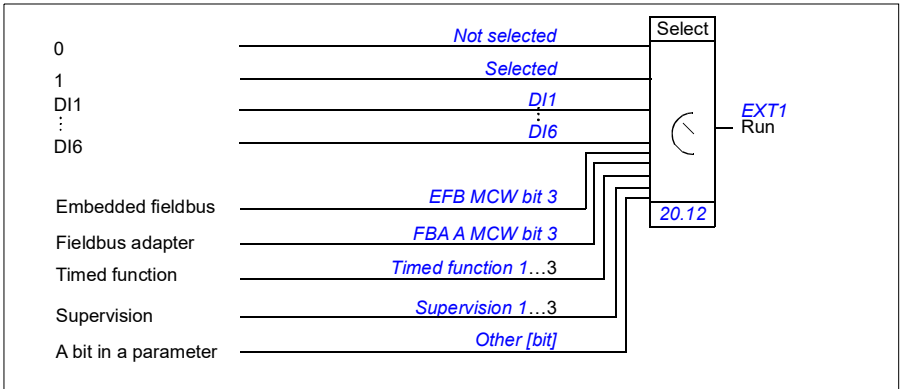

Settings and diagnostics

**Menu - Primary settings - Start, stop, reference - Secondary control location;**  
**Menu - Primary settings - Start, stop, reference**

Parameters: [19.11 Ext1/Ext2 selection](#) (page 245) and [20.01 Ext1 commands...20.10 Ext2 in3 source](#) (page 247).

Events: -

## Operating modes of the drive

The drive can operate in several operating modes with different types of reference. The mode is selectable for each control location (Local, EXT1 and EXT2) in parameter group [19 Operation mode](#). An overview of the different reference types and control chains is shown below.

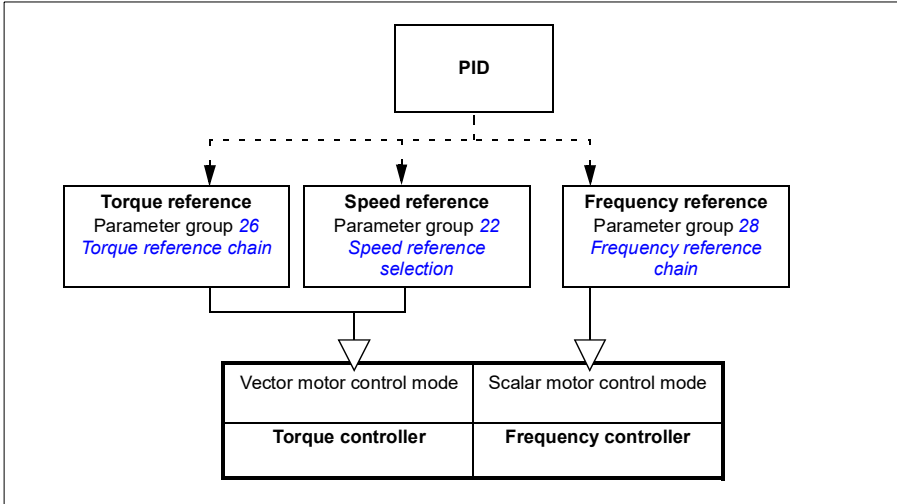

The following is a more detailed representation of the reference types and control chains. The page numbers refer to detailed diagrams in chapter [Control chain diagrams](#).



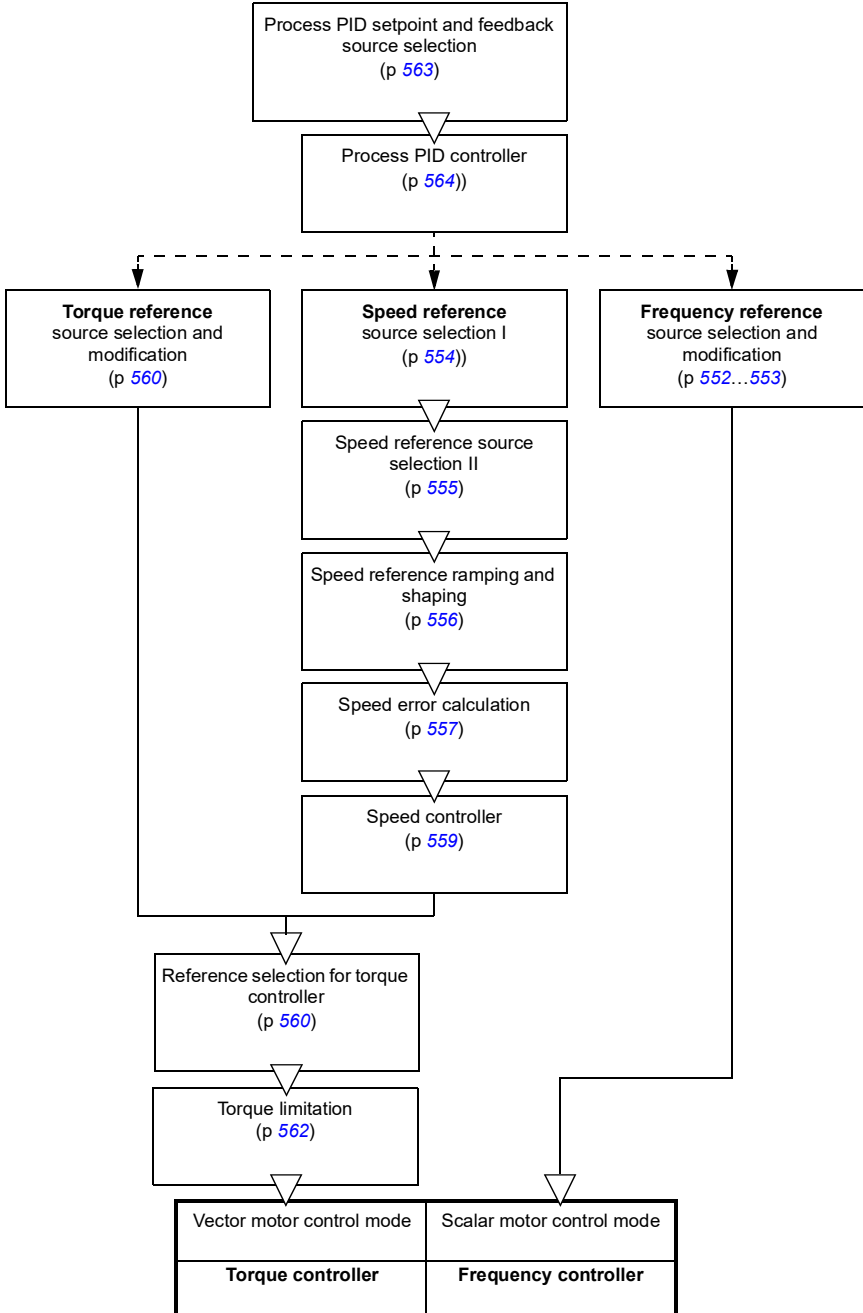

## ■ Speed control mode

The motor follows a speed reference given to the drive. This mode can be used either with estimated speed used as feedback.

Speed control mode is available in both local and external control. It is supported in vector motor control only.

Speed control uses speed reference chain. Select speed reference with parameters in group [22 Speed reference selection](#) on page [266](#).

### Settings and diagnostics

Parameter group: [22 Speed reference selection](#) (page [266](#)).

Events: -

## ■ Torque control mode

Motor torque follows a torque reference given to the drive. Torque control mode is available in both local and external control. It is supported in vector motor control only.

Torque control uses torque reference chain. Select torque reference with parameters in group [26 Torque reference chain](#) on page [286](#).

### Settings and diagnostics

Parameter group: [26 Torque reference chain](#) (page [286](#)).

Events: -

## ■ Frequency control mode

The motor follows a frequency reference given to the drive. Frequency control is available in both local and external control. It is supported in scalar motor control only.

Frequency control uses frequency reference chain. Select frequency reference with parameters in group [28 Frequency reference chain](#) on page [290](#).

### Settings and diagnostics

Parameter group: [28 Frequency reference chain](#) (page [290](#)).

Events: -

---

## ■ Special control modes

In addition to the above-mentioned control modes, the following special control modes are available:

- Process PID control. For more information, see section [Process PID control](#) (page 131).
- Emergency stop modes OFF1 and OFF3: Drive stops along the defined deceleration ramp and drive modulation stops, see section [Emergency stop](#) (page 176).
- Jogging mode: Drive starts and accelerates to the defined speed when the jogging signal is activated. For more information, see section [Jogging](#) (page 165).
- Pre-magnetization: DC magnetization of the motor before start. For more information, see section [Pre-magnetization](#) (page 161).
- DC hold: Locking the rotor at (near) zero speed in the middle of normal operation. For more information, see section [DC hold](#) (page 162).
- Pre-heating (motor heating): Keeping the motor warm when the drive is stopped. For more information, see section [Pre-heating \(Motor heating\)](#) (page 163).

### Settings and diagnostics

Parameter groups: [06 Control and status words](#) (page 208), [20 Start/stop/direction](#) (page 247), [22 Speed reference selection](#) (page 266), [23 Speed reference ramp](#) (page 276 and [40 Process PID set 1](#) (page 353).

Events: -

---

## Drive configuration and programming

The drive control program performs the main control functions, including speed, torque and frequency control, drive logic (start/stop), I/O, feedback, communication and protection functions. Control program functions are configured and programmed with parameters.

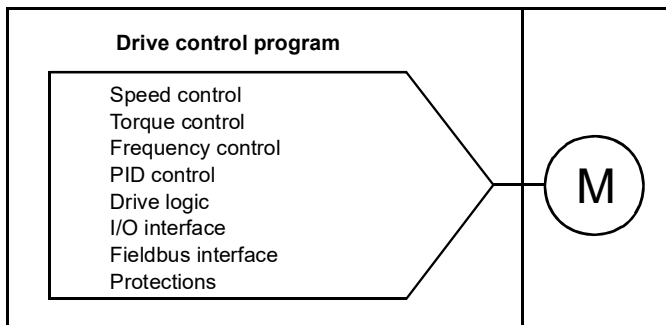

### ■ Configuring via parameters

Parameters configure all of the standard drive operations and can be set via

- the control panel, as described in chapter [Control panel](#)
- the Drive composer PC tool, as described in *Drive composer user's manual* (3AUA0000094606 [English]), or
- the fieldbus interface, as described in chapters [Fieldbus control through the embedded fieldbus interface \(EFB\)](#) and [Fieldbus control through a fieldbus adapter](#).

All parameter settings are stored automatically to the permanent memory of the drive. However, if an external +24 V DC power supply is used for the drive control unit, ABB highly recommends to force a save by using parameter [96.07 Parameter save manually](#) before powering down the control unit after any parameter changes have been made.

If necessary, the default parameter values can be restored by parameter [96.06 Parameter restore](#).

### Settings and diagnostics

Parameters: [96.06 Parameter restore](#)...[96.07 Parameter save manually](#) (page 418).

Events: -

## ■ Adaptive programming

Conventionally, the user can control the operation of the drive by parameters. However, the standard parameters have a fixed set of choices or a setting range. To further customize the operation of the drive, an adaptive program can be constructed out of a set of function blocks.

The Drive composer pro PC tool (version 1.10 or later, available separately) has an Adaptive programming feature with a graphical user interface for building the custom program. The function blocks include the usual arithmetic and logical functions, as well as for example, selection, comparison and timer blocks. The adaptive program is executed on a 10 ms time level.

The physical inputs, drive status information, actual values, constants and parameters can be used as the input for the program. The output of the program can be used for example, as a start signal, external event or reference, or connected to the drive outputs. See the table below for a listing of the available inputs and outputs.

If you connect the output of the adaptive program to a selection parameter that is a pointer parameter, the selection parameter will be write-protected.

### Example

If parameter [31.01 External event 1 source](#) is connected to an adaptive programming block output, the parameter value is shown as Adaptive program on a control panel or PC tool. The parameter is write-protected (= the selection cannot be changed).

The status of the adaptive program is shown by parameter [07.30 Adaptive program status](#). The adaptive program can be disabled by [96.70 Disable adaptive program](#).

For more information, see the [Adaptive programming application guide](#) (3AXD50000028574 [English]).

Inputs available to the adaptive program	
Input	Source
I/O	
DI1	<a href="#">10.02 DI delayed status</a> , bit 0
DI2	<a href="#">10.02 DI delayed status</a> , bit 1
DI3	<a href="#">10.02 DI delayed status</a> , bit 2
DI4	<a href="#">10.02 DI delayed status</a> , bit 3
DI5	<a href="#">10.02 DI delayed status</a> , bit 4
DI6	<a href="#">10.02 DI delayed status</a> , bit 5
AI1	<a href="#">12.11 AI1 actual value</a>
AI2	<a href="#">12.21 AI2 actual value</a>
Actual signals	
Motor speed	<a href="#">01.01 Motor speed used</a>
Output frequency	<a href="#">01.06 Output frequency</a>
Motor current	<a href="#">01.07 Motor current</a>
Motor torque	<a href="#">01.10 Motor torque</a>
Motor shaft power	<a href="#">01.17 Motor shaft power</a>
Status	
Enabled	<a href="#">06.16 Drive status word 1</a> , bit 0

<b>Inputs available to the adaptive program</b>	
<i>Input</i>	<i>Source</i>
Inhibited	<a href="#">06.16 Drive status word 1, bit 1</a>
Ready to start	<a href="#">06.16 Drive status word 1, bit 3</a>
Tripped	<a href="#">06.11 Main status word, bit 3</a>
At setpoint	<a href="#">06.11 Main status word, bit 8</a>
Limiting	<a href="#">06.16 Drive status word 1, bit 7</a>
Ext1 active	<a href="#">06.16 Drive status word 1, bit 10</a>
Ext2 active	<a href="#">06.16 Drive status word 1, bit 11</a>
<i>Data storage</i>	
Data storage 1 real32	<a href="#">47.01 Data storage 1 real32</a>
Data storage 2 real32	<a href="#">47.02 Data storage 2 real32</a>
Data storage 3 real32	<a href="#">47.03 Data storage 3 real32</a>
Data storage 4 real32	<a href="#">47.04 Data storage 4 real32</a>

<b>Outputs available to the adaptive program</b>	
<i>Output</i>	<i>Target</i>
<i>I/O</i>	
RO1	<a href="#">10.24 RO1 source</a>
RO2	<a href="#">10.27 RO2 source</a>
RO3	<a href="#">10.30 RO3 source</a>
AO1	<a href="#">13.12 AO1 source</a>
AO2	<a href="#">13.22 AO2 source</a>
<i>Start control</i>	
Ext1/Ext2 selection	<a href="#">19.11 Ext1/Ext2 selection</a>
Run enable 1	<a href="#">20.12 Run enable 1 source</a>
Ext1 in1 cmd	<a href="#">20.03 Ext1 in1 source</a>
Ext1 in2 cmd	<a href="#">20.04 Ext2 in2 source</a>
Ext1 in3 cmd	<a href="#">20.05 Ext1 in3 source</a>
Ext2 in1 cmd	<a href="#">20.08 Ext2 in1 source</a>
Ext2 in2 cmd	<a href="#">20.09 Ext2 in2 source</a>
Ext2 in3 cmd	<a href="#">20.10 Ext2 in3 source</a>
Fault reset	<a href="#">31.11 Fault reset selection</a>
<i>Speed control</i>	
Ext1 speed reference	<a href="#">22.11 Ext1 speed ref1</a>
Speed proportional gain	<a href="#">25.02 Speed proportional gain</a>
Speed integration time	<a href="#">25.03 Speed integration time</a>
Acceleration time 1	<a href="#">23.12 Acceleration time 1</a>
Deceleration time 1	<a href="#">23.13 Deceleration time 1</a>
<i>Frequency control</i>	
Ext1 frequency reference	<a href="#">28.11 Ext1 frequency ref1</a>
<i>Torque control</i>	
Ext1 torque reference	<a href="#">26.11 Torque ref1 source</a>
Ext2 torque reference	<a href="#">26.12 Torque ref2 source</a>
<i>Limit function</i>	
Minimum torque 2	<a href="#">30.21 Min torque 2 source</a>
Maximum torque 2	<a href="#">30.22 Max torque 2 source</a>
<i>Events</i>	
External event 1	<a href="#">31.01 External event 1 source</a>
External event 2	<a href="#">31.03 External event 2 source</a>

<b>Outputs available to the adaptive program</b>	
<i>Output</i>	<i>Target</i>
External event 3	<a href="#">31.05 External event 3 source</a>
External event 4	<a href="#">31.07 External event 4 source</a>
External event 5	<a href="#">31.09 External event 5 source</a>
<i>Data Storage</i>	
Data storage 1 real32	<a href="#">47.01 Data storage 1 real32</a>
Data storage 2 real32	<a href="#">47.02 Data storage 2 real32</a>
Data storage 3 real32	<a href="#">47.03 Data storage 3 real32</a>
Data storage 4 real32	<a href="#">47.04 Data storage 4 real32</a>
<i>Process PID</i>	
Set 1 setpoint 1	<a href="#">40.16 Set 1 setpoint 1 source</a>
Set 1 setpoint 2	<a href="#">40.17 Set 1 setpoint 2 source</a>
Set 1 feedback 1	<a href="#">40.08 Set 1 feedback 1 source</a>
Set 1 feedback 2	<a href="#">40.09 Set 1 feedback 2 source</a>
Set 1 gain	<a href="#">40.32 Set 1 gain</a>
Set 1 integration time	<a href="#">40.33 Set 1 integration time</a>
Set 1 tracking mode	<a href="#">40.49 Set 1 tracking mode</a>
Set 1 track reference	<a href="#">40.50 Set 1 tracking ref selection</a>

### Adaptive program fault and aux code formats

The format of the aux code:

Bits 24-31: State number	Bits 16-23: block number	Bits 0-15: error code
--------------------------	--------------------------	-----------------------

If the state number is zero but the block number has a value, the fault is related to a function block in the base program. If both state number and block number are zero, the fault is a generic fault that is not related to a specific block.

See fault [64A6](#).

### Sequence program

An adaptive program can contain base program and sequence program parts. Base program is run continuously when adaptive program is in running mode. The functionality of the base program is programmed using function blocks and system inputs and outputs.

Sequence program is a state machine. This means that only one state of the sequence program is run at a time. You can create a sequence program by adding states and programming the state programs using the same program elements as in the base program. You can program state transitions by adding state transition outputs to the state programs. The state transition rules are programmed using function blocks.

The number of the active state of the sequence program is shown by parameter [07.31 AP sequence state](#).

Settings and diagnostics

Parameter groups: [01 Actual values](#) (page 199), [06 Control and status words](#) (page 208), [07 System info](#) (page 214), [10 Standard DI, RO](#) (page 216), [12 Standard AI](#) (page 226), [13 Standard AO](#) (page 231), [19 Operation mode](#) (page 245), [20 Start/stop/direction](#) (page 247), [23 Speed reference ramp](#) (page 276), [25 Speed control](#) (page 280), [26 Torque reference chain](#) (page 286), [30 Limits](#) (page 301), [31 Fault functions](#) (page 309), [40 Process PID set 1](#) (page 353), [47 Data storage](#) (page 383), and [96 System](#) (page 415).

Event: [64A6 Adaptive program](#) (page 498).

---



## Control interfaces

### ■ Programmable analog inputs

The control unit has two programmable analog inputs. Each of the inputs can be independently set as a voltage (0/2...10 V) or current (0/4...20 mA) input with parameters. Each input can be filtered, inverted and scaled.

#### Settings and diagnostics

Parameter group: [12 Standard AI](#) (page [226](#)).

Events: -

### ■ Programmable analog outputs

The control unit has two current (0...20 mA) analog outputs. Analog output 1 can be set as a voltage (0/2...10 V) or current (0/4...20 mA) output with a parameter. Analog output 2 always uses current. Each output can be filtered, inverted and scaled.

#### Settings and diagnostics

Parameter group: [13 Standard AO](#) (page [231](#)).

Events: -

### ■ Programmable digital inputs and outputs

The control unit has six digital inputs.

Digital input DI5 can be used as a frequency input. The control panel shows the appropriate selection only.

Digital input DI6 can be used as a thermistor input.

Six digital inputs can be added by using a CHDI-01 115/230 V digital input extension module and one digital output by using a CMOD-01 multifunction extension module.

#### Settings and diagnostics

Parameter groups: [10 Standard DI, RO](#) (page [216](#)) and [11 Standard DIO, FI, FO](#) (page [225](#)).

Events: -

### ■ Programmable frequency input and output

Digital input DI5 can be used as a frequency input.

A frequency output can be implemented with a CMOD-01 multifunction extension module.

---

Settings and diagnostics

Parameter groups: [10 Standard DI, RO](#) (page 216) and [11 Standard DIO, FI, FO](#) (page 225).

Events: -

■ **Programmable relay outputs**

The control unit has three relay outputs. The signal to be indicated by the outputs can be selected by parameters.

Two relay outputs can be added by using a CMOD-01 multifunction extension module or a CHDI-01 115/230 V digital input extension module.

Settings and diagnostics

Parameter group: [10 Standard DI, RO](#) (page 216).

Events: -

■ **Programmable I/O extensions**

Inputs and outputs can be added by using a CMOD-01 or CMOD-02 multifunction extension module or a CHDI-01 115/230 V digital input extension module. The module is mounted on option slot 2 of the control unit.

The table below shows the number of I/O on the control unit as well as optional CMOD-01, CMOD-02 and a CHDI-01 modules.

Location	Digital inputs (DI)	Digital outputs (DO)	Digital I/Os (DIO)	Analog inputs (AI)	Analog outputs (AO)	Relay outputs (RO)
Control unit	6	-	-	2	2	3
CMOD-01	-	1	-	-	-	2
CMOD-02	-	-	-	-	-	1 (non-configurable)
CHDI-01	6 (115/230 V)	-	-	-	-	2

The I/O extension module can be activated and configured using parameter group 15.

The CMOD-02 offers, in addition to the relay output (non-configurable), a +24VDC/AC input and a thermistor input.

**Note:** The configuration parameter group contains parameters that display the values of the inputs on the extension module. These parameters are the only way of utilizing the inputs on an I/O extension module as signal sources. To connect to an input, choose the setting *Other* in the source selector parameter, then specify the appropriate value parameter (and bit, for digital signals) in group 15.

**Note:** With the CHDI-01, you can use up to six additional digital inputs. The CHDI-01 does not affect the standard digital inputs on the control unit.

### Settings and diagnostics

Parameter group: [15 I/O extension module](#) (page [236](#)).

Events: -

### ■ **Fieldbus control**

The drive can be connected to several different automation systems through its fieldbus interfaces. See chapters [Fieldbus control through the embedded fieldbus interface \(EFB\)](#) (page [505](#)) and [Fieldbus control through a fieldbus adapter](#) (page [535](#)).

### Settings and diagnostics

Parameter groups: [50 Fieldbus adapter \(FBA\)](#) (page [386](#)), [51 FBA A settings](#) (page [390](#)), [52 FBA A data in](#) (page [392](#)), and [53 FBA A data out](#) (page [392](#)) and [58 Embedded fieldbus](#) (page [393](#)).

Events: -

## **Application control**

### ■ **Reference ramping**

Acceleration and deceleration ramping times can be set individually for speed, torque and frequency reference (**Menu - Primary settings - Ramps**).

With a speed or frequency reference, the ramps are defined as the time it takes for the drive to accelerate or decelerate between zero speed or frequency and the value defined by parameter [46.01](#) or [46.02](#). The user can switch between two preset ramp sets using a binary source such as a digital input. For speed and frequency reference, also the shape of the ramp can be controlled.

With a torque reference, the ramps are defined as the time it takes for the reference to change between zero and nominal motor torque (parameter [01.30](#)).

### **Variable slope**

Variable slope controls the slope of the speed ramp during a reference change. With this feature a constantly variable ramp can be used. See parameters [23.28](#) and [23.29](#).

Variable slope is only supported in remote control.

### **Special acceleration/deceleration ramps**

The acceleration/deceleration times for the jogging function can be defined separately; see section [Jogging](#) (page [165](#)).

---

The change rate of the motor potentiometer function (page 150) is adjustable. The same rate applies in both directions.

A deceleration ramp can be defined for emergency stop (“Off3” mode).

### Settings and diagnostics

#### **Menu - Primary settings - Ramps**

Parameters:

- Speed reference ramping: Parameters [23.11 Ramp set selection...23.15 Deceleration time 2](#) (page 276) and [46.01 Speed scaling](#) (pages 379).
- Torque reference ramping: Parameters [01.30 Nominal torque scale](#) (page 200), [26.18 Torque ramp up time](#) and [26.19 Torque ramp down time](#)(pages 289).
- Frequency reference ramping: Parameters [28.71 Freq ramp set selection...28.75 Freq deceleration time 2](#) (page 298) and [46.02 Frequency scaling](#) (pages 379).
- Jogging: Parameters [23.20 Acc time jogging](#) and [23.21 Dec time jogging](#) (page 277).
- Motor potentiometer: Parameter [22.75 Motor potentiometer ramp time](#) (page 275).
- Emergency stop (“Off3” mode): Parameter [23.23 Emergency stop time](#) (page 278).
- Variable slope: Parameters [23.28 Variable slope enable](#) (page 278) and [23.29 Variable slope rate](#) (page 278).

Events: -

#### ■ **Constant speeds/frequencies**

Constant speeds and frequencies are predefined references that can be quickly activated, for example, through digital inputs. It is possible to define up to 7 speeds for speed control and 7 constant frequencies for frequency control.



**WARNING:** Speeds and frequencies override the normal reference irrespective of where the reference is coming from.

---

### Settings and diagnostics

#### **Menu - Primary settings - Start, stop, reference - Constant frequencies, Menu - Primary settings - Start, stop, reference - Constant speeds**

Parameter groups: [22 Speed reference selection](#) (page 266) and [28 Frequency reference chain](#) (page 290).

Events: -

---

## ■ Critical speeds/frequencies

Critical speeds (sometimes called “skip speeds”) can be predefined for applications where it is necessary to avoid certain motor speeds or speed ranges because of, for example, mechanical resonance problems.

The critical speeds function prevents the reference from dwelling within a critical band for extended times. When a changing reference ([22.87 Speed reference act 7](#)) enters a critical range, the output of the function ([22.01 Speed ref unlimited](#)) freezes until the reference exits the range. Any instant change in the output is smoothed out by the ramping function further in the reference chain.

When the drive is limiting the allowed output speeds/frequencies, it limits to the absolutely lowest critical speed (critical speed low or critical frequency low) when accelerating from standstill, unless the speed reference is over the upper critical speed/ frequency limit.

The function is also available for scalar motor control with a frequency reference. The input of the function is shown by [28.96 Frequency ref act 7](#).

### Example

A fan has vibrations in the range of 540...690 rpm and 1380...1560 rpm. To make the drive avoid these speed ranges,

- the critical speeds function by turning on bit 0 of parameter [22.51 Critical speed function](#), and
- set the critical speed ranges as in the figure below.

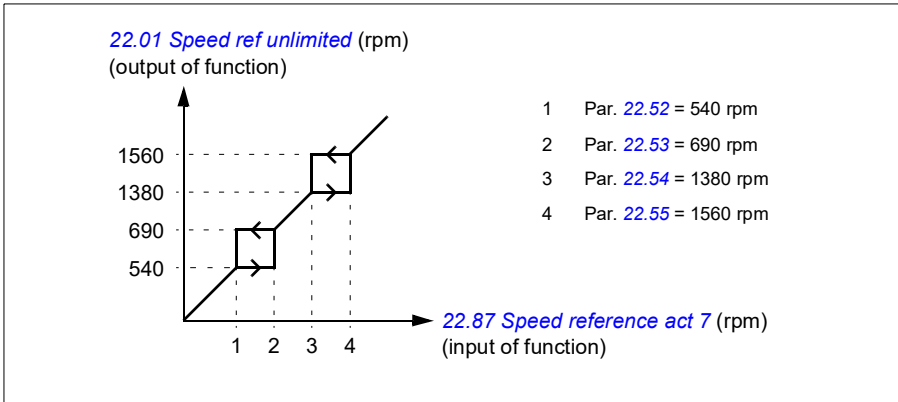

Settings and diagnostics

Parameters:

- Critical speeds: Parameters [22.01 Speed ref unlimited](#) (page 266), [22.51 Critical speed function...](#)[22.57 Critical speed 3 high](#) (page 273) and [22.87 Speed reference act 7](#) (page 276).
- Critical frequencies: Parameters [28.51 Critical frequency function...](#)[28.57 Critical frequency 3 high](#) (page 297) and [28.96 Frequency ref act 7](#) (page 301).

Events: -

### ■ Speed controller autotune

The speed controller of the drive can be automatically adjusted using the autotune function. Autotuning is based on an estimation of the mechanical time constant (inertia) of the motor and machine.

The autotune routine will run the motor through a series of acceleration/deceleration cycles, the number of which can be adjusted by parameter [25.40](#). Higher values will produce more accurate results, especially if the difference between initial and maximum speeds is small.

The maximum torque reference used during autotuning will be the initial torque (that is, torque when the routine is activated) plus [25.38](#), unless limited by the maximum torque limit (parameter group [30 Limits](#)) or the nominal motor torque ([99 Motor data](#)). The calculated maximum speed during the routine is the initial speed (that is, speed when the routine is activated) + [25.39](#), unless limited by parameter [30.12](#) or [99.09](#).

The diagram below shows the behavior of speed and torque during the autotune routine. In this example, [25.40](#) is set to 2.

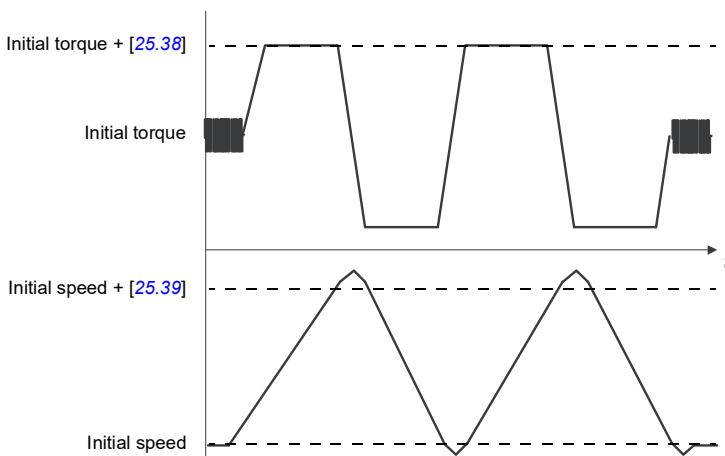

**Notes:**

- If the drive cannot produce the requested braking power during the routine, the results will be based on the acceleration stages only, and not as accurate as with full braking power.
- The motor will exceed the calculated maximum speed slightly at the end of each acceleration stage.

**Before activating the autotune routine**

The prerequisites for performing the autotune routine are:

- The motor identification run (ID run) has been successfully completed
- Speed and torque limits (parameter group [30 Limits](#)) have been set
- The drive has been started and is running in speed control mode.

After these conditions have been fulfilled, autotuning can be activated by parameter [25.33](#) (or the signal source selected by it).

**Autotune modes**

Autotuning can be performed in three different ways depending on the setting of parameter [25.34](#). The selections *Smooth*, *Normal* and *Tight* define how the drive torque reference should react to a speed reference step after tuning. The selection *Smooth* will produce a slow but robust response; *Tight* will produce a fast response

---

but possibly too high gain values for some applications. The figure below shows speed responses at a speed reference step (typically 1...20%).

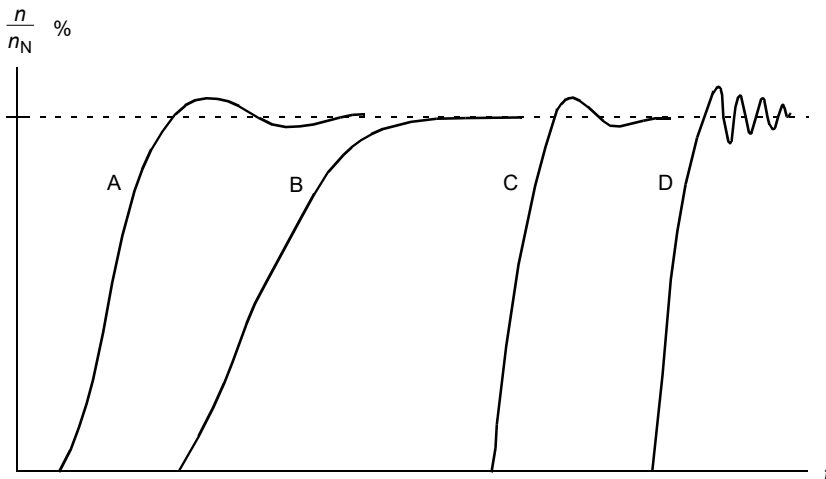

A: Undercompensated

B: Normally tuned (autotuning)

C: Normally tuned (manually). Better dynamic performance than with B

D: Overcompensated speed controller

### Autotune results

At the end of a successful autotune routine, its results are automatically transferred into parameters

- [25.02](#) (proportional gain of the speed controller)
- [25.03](#) (integration time of the speed controller)
- [25.37](#) (mechanical time constant of the motor and machine).

Nevertheless, it is still possible to manually adjust the controller gain, integration time and derivation time.



The figure below is a simplified block diagram of the speed controller. The controller output is the reference for the torque controller.

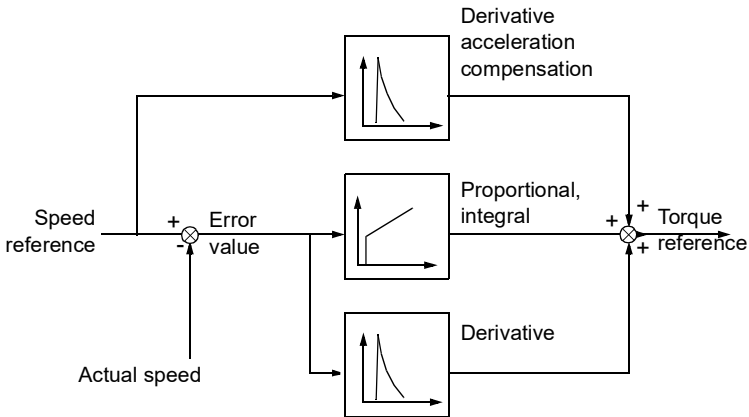

### Warning indications

A warning message [AF90](#), will be generated if the autotune routine does not complete successfully. See chapter [Fault tracing](#) (page 479) for further information.

### Settings and diagnostics

Parameters groups: [25 Speed control](#) (page 280), [30 Limits](#) (page 301) and [99 Motor data](#) (page 431).

Parameters: [25.02 Speed proportional gain](#) (page 281), [25.03 Speed integration time](#) (page 282), [25.33 Speed controller autotune...](#)[25.40 Autotune repeat times](#) (page 285), [30.12 Maximum speed](#) (page 303) and [99.09 Motor nominal speed](#) (page 433).

Event: [AF90 Speed controller autotuning](#) (page 491).

### ■ User load curve

The User load curve provides a supervisory function that monitors an input signal as a function of frequency or speed, and load. It shows the status of the monitored signal and can give a warning or fault based on the violation of a user defined profile.

The user load curve consists of an overload and an underload curve, or just one of them. Each curve is formed by five points that represent the monitored signal as a function of frequency or speed.

In the example below, the user load curve is constructed from the motor nominal torque to which a 10% margin is added and subtracted. The margin curves define a

working envelope for the motor so that excursions outside the envelope can be supervised, timed and detected.

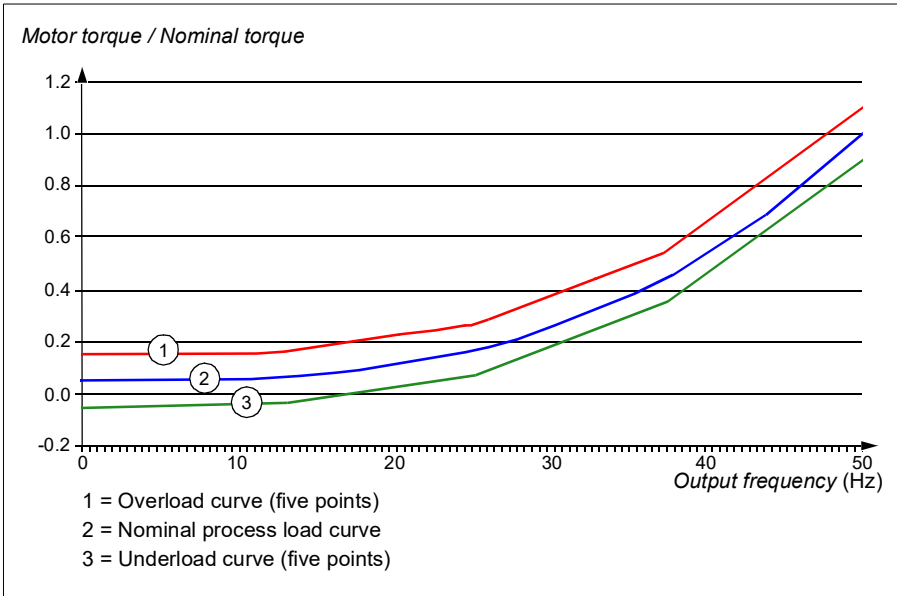

An overload warning and/or fault can be set to occur if the monitored signal stays continuously over the overload curve for a defined time. An underload warning and/or fault can be set to occur if the monitored signal stays continuously under the underload for a defined time.

Overload can be for example used to monitor for a saw blade hitting a knot or fan load profiles becoming too high.

Underload can be for example used to monitor for load dropping and breaking of conveyer belts or fan belts.

### Settings and diagnostics

Parameter group: [37 User load curve](#) (page 349).

Events: [A6E6 ULC configuration](#) (page 487), [A8BE ULC overload warning](#) (page 490), [A8BF ULC underload warning](#) (page 490), [8001 ULC underload fault](#) (page 501), [8002 ULC overload fault](#) (page 501).

### ■ Control macros

Control macros are predefined parameter edits and I/O configurations. See chapter [Control macros](#) (page 77).

## ■ Process PID control

There are two built-in process PID controllers (PID set 1 and PID set 2) in the drive. The controller can be used to control process variables such as pressure or flow in the pipe or fluid level in the container.

In process PID control, a process reference (setpoint) is connected to the drive instead of a speed reference. An actual value (process feedback) is also brought back to the drive. The process PID control adjusts the drive speed in order to keep the measured process quantity (actual value) at the desired level (setpoint). This means that user does not need to set a frequency/speed/torque reference to the drive but the drive adjust its operation according to the process PID.

The simplified block diagram below illustrates the process PID control. For more detailed block diagrams, see pages [563](#) and [564](#).

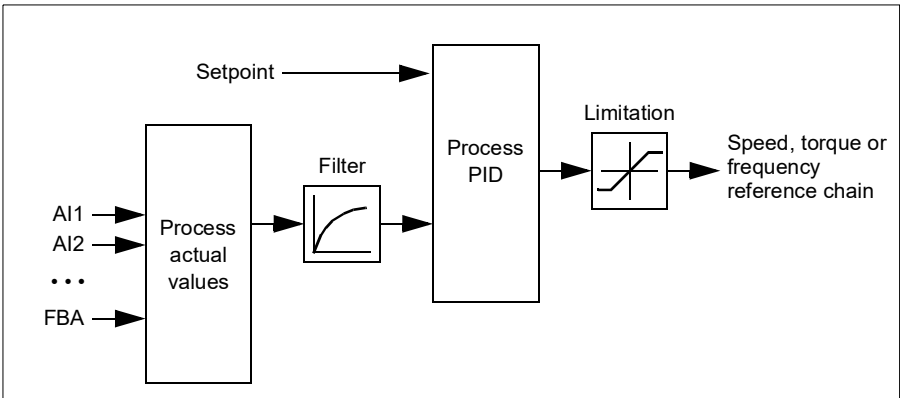

The drive contains two complete sets of process PID controller settings that can be alternated whenever necessary; see parameter [40.57 PID set1/set2 selection](#).

**Note:** Process PID control is only available in external control; see section [Local control vs. external control](#) (page [107](#)).

### Quick configuration of the process PID controller

1. Activate the process PID controller: **Menu - Primary settings - PID - PID controls**
2. Select a feedback source: **Menu - Primary settings - PID - Feedback**
3. Select a setpoint source: **Menu - Primary settings - PID - Setpoint**
4. Set the gain, integration time, derivation time: **Menu - Primary settings - PID - Tuning**
5. Set the PID output limits: **Menu - Primary settings - PID - PID output**
6. Select the PID controller output as the source of, for example, [22.11 Ext1 speed ref1](#): **Menu - Primary settings - Start, stop, reference - Reference from**

### Sleep and boost functions for process PID control

The sleep function is suitable for PID control applications where the consumption varies, such as clean water pumping systems. When used, it stops the pump completely during low demand, instead of running the pump slowly below its efficient operating range. The following example visualizes the operation of the function.

**Example:** The drive controls a pressure boost pump. The water consumption falls at night. As a consequence, the process PID controller decreases the motor speed. However, due to natural losses in the pipes and the low efficiency of the centrifugal pump at low speeds, the motor would never stop rotating. The sleep function detects the slow rotation and stops the unnecessary pumping after the sleep delay has passed. The drive shifts into sleep mode, still monitoring the pressure. The pumping resumes when the pressure falls under the predefined minimum level and the wake-up delay has passed.

The user can extend the PID sleep time by the boost functionality. The boost functionality increases the process setpoint for a predetermined time before the drive enters the sleep mode.

---

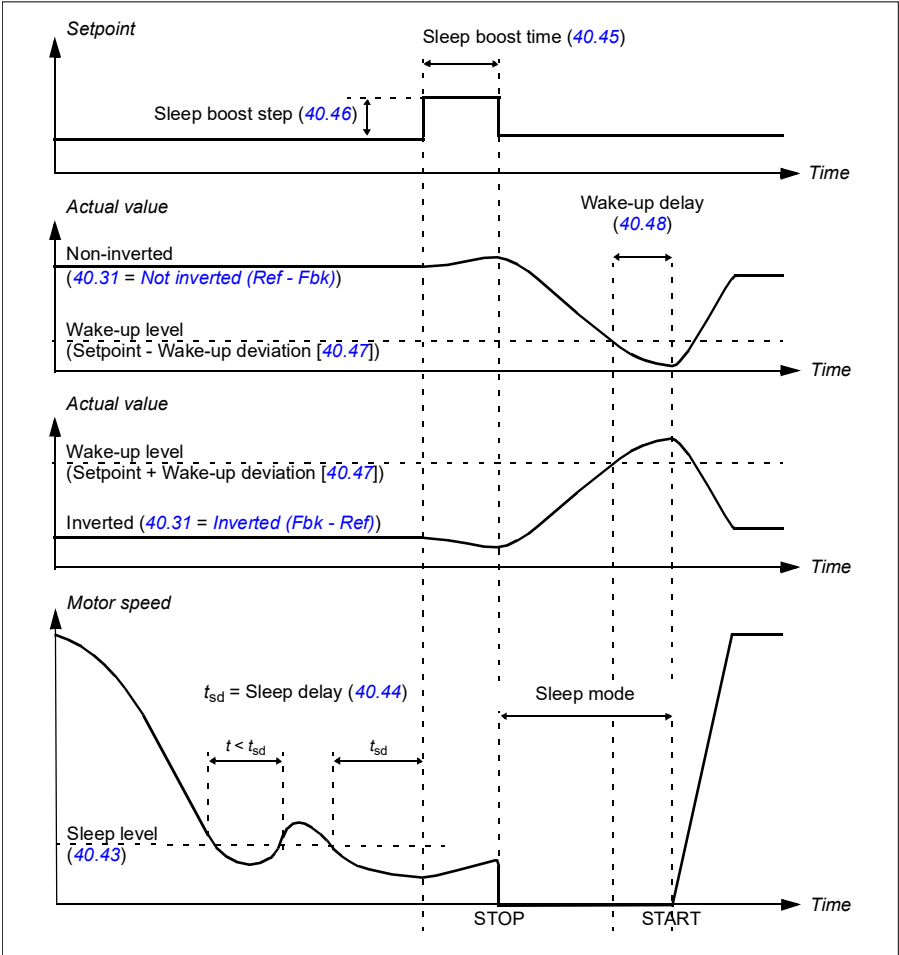

## **Tracking**

In tracking mode, the PID block output is set directly to the value of parameter [40.50](#) (or [41.50](#)) *Set 1 tracking ref selection*. The internal I term of the PID controller is set so that no transient is allowed to pass on to the output, so when the tracking mode is left, normal process control operation can be resumed without a significant bump.

### Settings and diagnostics

#### **Menu - Primary settings - PID**

Parameter: [96.04 Macro select](#) (page [417](#)) (macro selection).

Parameter groups: [40 Process PID set 1](#) (page [353](#)) and [41 Process PID set 2](#) (page [369](#)).

Events: -

---

## ■ PID trim function

The PID trim function is used to maintain the set tension either by trimming the drive main speed reference or torque reference (speed controller output).



**WARNING:** Make sure that the drive acceleration and deceleration time is set to 0 when using PID trim function. This is required to do quick tension control by speed correction.

PID trim is implemented as one of the Process PID functions (parameter groups [40 Process PID set 1](#) and [41 Process PID set 2](#)). Both PID set 1 and PID set 2 can be used for this functionality.

The trimmed output is calculated from parameter [40.01 Process PID output actual](#) or [40.03 Process PID setpoint actual](#). This is based on the selection in parameter [40.56 Set 1 trim source](#) (for process PID set 1) or [41.56 Set 2 trim source](#) (for process PID set 2). In most of the use cases, [40.01 Process PID output actual](#) is used, that is [40.56 Set 1 trim source](#) or [41.56 Set 2 trim source](#) is set to [PID output](#).

PID trim functionality in Variable Frequency Drives (VFD) is used in applications where tension control of the material is very essential, for example, in auxiliary drives in metal process industries, infeed and outfeed of rotogravure printing machines and surface winders.

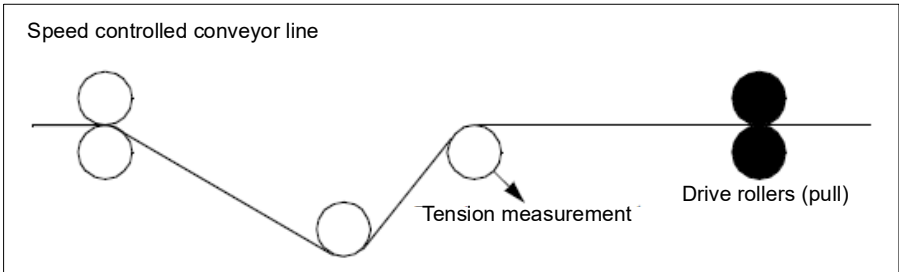

You must link the trimmed output from PID to the speed chain manually if PID trimmed output is used for trimming speed. Set the below parameters as follows:

Parameter	Value
<a href="#">22.11 Ext1 speed ref1</a>	Process speed reference given by <a href="#">22.11 Ext1 speed ref1</a> source
<a href="#">22.12 Ext1 speed ref2</a>	Other, <a href="#">40.05 Process PID trim output act</a>
<a href="#">22.13 Ext1 speed function</a>	<i>Add (ref1 + ref2)</i>

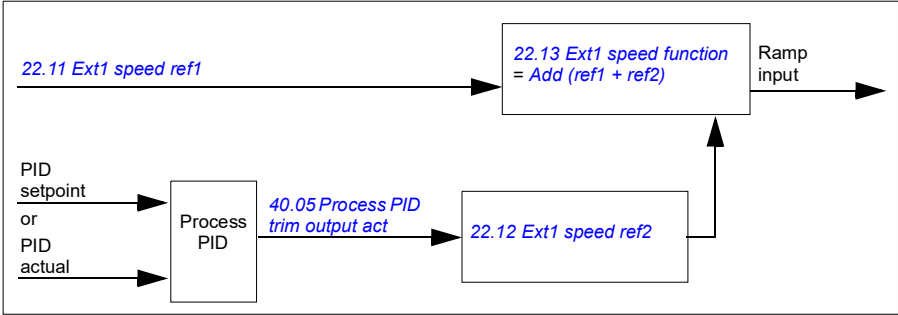

**Notes:**

- The above settings are for EXT1 control location. Accordingly, you can set for EXT2 control location.
- The examples provided here are based on PID set 1. You can set the desired values for PID trim function's parameters to get the expected result.

The following PID trim modes are available:

- *Direct*
- *Proportional*
- *Combined*.

**Direct**

The direct mode is suitable where you need tension control at fixed rpm/line speed.

In this mode, the PID trimmed output (*40.05 Process PID trim output act*) is relative to the maximum speed (parameter *30.12 Maximum speed*), torque (*30.20 Maximum torque 1*) or frequency (*30.14 Maximum frequency*). You make the selection with parameter *40.52 Set 1 trim selection*.

The calculated trimmed output actual is the same throughout the speed range with respect to the stable PID output.

The *40.05 Process PID trim output act* is calculated using the below formula:

$$\text{Par40.05} = \left( \frac{\text{Par40.01}}{100} \right) \times (\text{Par30.12 or } \text{30.20 or } \text{30.14}) \times \text{Par40.55}$$



The below graph shows the PID trim output in direct mode throughout the speed range. A fixed trim speed reference is added throughout the speed range.

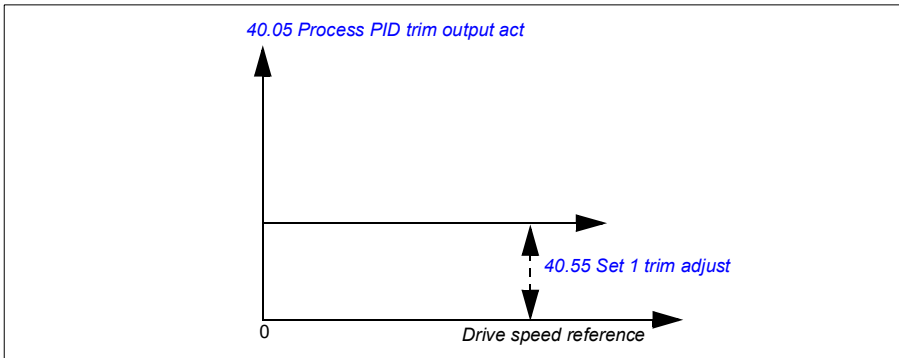

**Note:** In the above graph, it is assumed that the PID output is limited/stable at 100. This is for understanding purpose only. In real case scenarios, PID output can vary based on the setpoint and actual.

### Example:

If,

parameter *40.52 Set 1 trim selection* = Speed

parameter *40.56 Set 1 trim source* = PID output

parameter *30.12 Maximum speed* = 1500 rpm

parameter *40.01 Process PID output actual* = 100 (limited to 100)

parameter *40.55 Set 1 trim adjust* = 0.5

then

$$\text{Par40.05} = \left(\frac{100}{100}\right) \times 1500 \times 0.5$$

$$\text{Par40.05} = 750$$

### Proportional

The proportional mode is suitable for applications where tension control is required throughout the speed range but not near zero speed.

In this mode, the PID trim output (*40.05 Process PID trim output act*) is relative to the reference selected by parameter *40.53 Set 1 trimmed ref pointer* and with *40.01 Process PID output actual* or *40.03 Process PID setpoint actual*.

It is recommended that the speed reference selected in *40.53 Set 1 trimmed ref pointer* and the reference source selected in *22.11 Ext1 speed ref1* are same. This is required to make the proportional mode active.

In most of the use cases, the process speed reference is connected to *40.53 Set 1 trimmed ref pointer*. For example, if EXT1 control mode is used and the reference

source is AI scaled, then [22.11 Ext1 speed ref1](#) and [40.53 Set 1 trimmed ref pointer](#) should be configured to AI1 scaled.

The [40.05 Process PID trim output act](#) calculated using the below formula:

$$\text{Par40.05} = \left( \frac{\text{Par40.01}}{100} \right) \times \text{Par40.53} \times \text{Par40.55}$$

The below graph shows the PID trim output in proportional mode throughout the speed range. Here, the trimmed output is directly proportional to the value of parameter [40.53 Set 1 trimmed ref pointer](#).

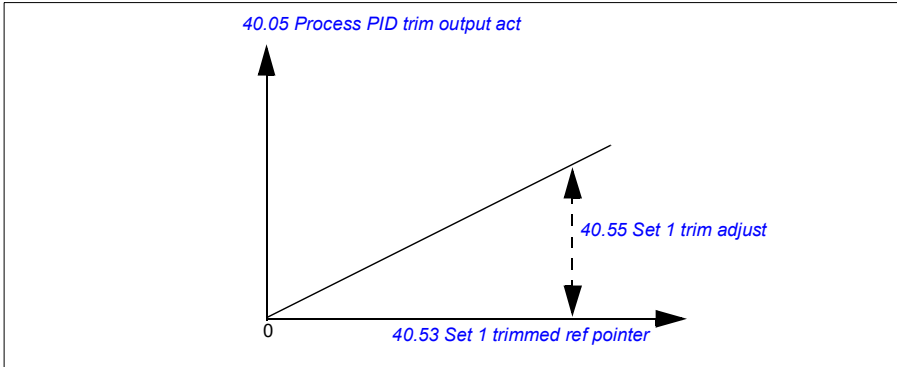

**Note:** In the above graph, it is assumed that the PID output is limited/stable at 100. This is for understanding purpose only. In real case scenario, PID output can vary based on the setpoint and actual.

### Example:

If,

parameter [40.52 Set 1 trim selection](#) = Speed

parameter [40.56 Set 1 trim source](#) = PID output

parameter [40.53 Set 1 trimmed ref pointer](#) = AI1 scaled

parameter [22.11 Ext1 speed ref1](#) = AI1 scaled

parameter [12.20 AI1 scaled at AI1 max](#) = 1500

parameter [12.12 AI1 scaled value](#) = 750 (AI1 actual scaled value)

parameter [40.01 Process PID output actual](#) = 100 (limited to 100)

parameter [40.55 Set 1 trim adjust](#) = 0.5

then

$$\text{Par40.05} = \left( \frac{100}{100} \right) \times 750 \times 0.5$$

$$\text{Par40.05} = 375$$

## Combined

The combined mode is suitable for applications where you need to maintain tension from zero speed to maximum speed.

The combined mode is a combination of direct and proportional mode. Here, the trim for zero speed is defined by [40.54 Set 1 trim mix](#) and the trim for speed greater than zero speed is defined by [40.55 Set 1 trim adjust](#). The trim value is directly proportional to value of [40.53 Set 1 trimmed ref pointer](#).

The process speed reference is connected in [40.53 Set 1 trimmed ref pointer](#). For example, if EXT1 control mode is used and the reference source is AI scaled, then [22.11 Ext1 speed ref1](#) and [40.53 Set 1 trimmed ref pointer](#) should be configured to *AI1 scaled*.

The [40.05 Process PID trim output act](#) is calculated using the below formula:

$$\text{Par40.05} = \{(\text{Par30.12} \times \text{Par40.54}) + [(1 - \text{Par40.54}) \times \text{Par40.53}]\} \times \text{Par40.55}$$

The below graph shows the trim increase in the combined mode.

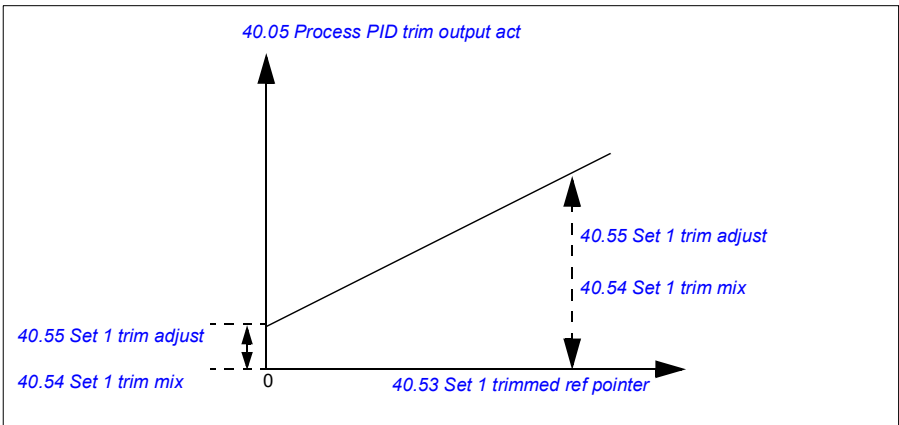

**Note:** In the above graph, it is assumed that the PID output is limited/stable at 100. This is for understanding purpose only. In real case scenario, PID output can vary based on the setpoint and actual.

**Example:**

If,  
 parameter [40.52 Set 1 trim selection](#) = *Speed*  
 parameter [40.56 Set 1 trim source](#) = *PID output*  
 parameter [30.12 Maximum speed](#) = 1500 rpm  
 parameter [40.53 Set 1 trimmed ref pointer](#) = *AI1 scaled*  
 parameter [22.11 Ext1 speed ref1](#) = *AI1 scaled*  
 parameter [12.20 AI1 scaled at AI1 max](#) = 1500  
 parameter [12.12 AI1 scaled value](#) = 750 (AI1 actual scaled value)  
 parameter [40.01 Process PID output actual](#) = 100 (limited to 100)  
 parameter [40.54 Set 1 trim mix](#) = 0.1  
 parameter [40.55 Set 1 trim adjust](#) = 0.5

then

If [40.53 Set 1 trimmed ref pointer](#) is 0

$$\text{Par40.05} = \left( \frac{100}{100} \right) \times \{ (1500 \times 0.1) + [(1 - 0.1) \times 0] \} \times 1$$

$$\text{Par40.05} = 150$$

If [40.53 Set 1 trimmed ref pointer](#) is 750

$$\text{Par40.05} = \left( \frac{100}{100} \right) \times \{ (1500 \times 0.1) + [(1 - 0.1) \times 750] \} \times 1$$

$$\text{Par40.05} = 825$$

If [40.53 Set 1 trimmed ref pointer](#) is 1500

$$\text{Par40.05} = \left( \frac{100}{100} \right) \times \{ (1500 \times 0.1) + [(1 - 0.1) \times 1500] \} \times 1$$

$$\text{Par40.05} = 1500$$

**PID trim auto connection**

PID trim auto connection ([40.54 Set 1 trim mix](#)) enables the connection of PID trim output actual ([40.05 Process PID trim output act](#)) to the respective speed, torque or frequency reference chains. You can use parameter [40.52 Set 1 trim selection](#) (for PID set 1) or [41.52 Set 2 trim selection](#) (for PID set 2) and select the respective trim (speed, torque or frequency).

The motor control mode ([99.04 Motor control mode](#)) also impacts the PID trim output actual ([40.05 Process PID trim output act](#)) added to the speed, torque or frequency reference chains. In scalar control mode, the speed trim and torque trim values are zero and in vector control mode, the frequency trim value is zero.

See the control chain diagram on page [568](#).

**Note:** If the parameter [40.54 Set 1 trim mix](#) is disabled and the drive stops through Ramp stop (Off1) or Emergency ramp stop (Off3) emergency stop mode ([21.04](#)

*Emergency stop mode*), the PID trim output actual (*40.05 Process PID trim output act*) is not added to the frequency reference chain during the drive deceleration condition.

#### Speed trim connection

Speed trim is added to parameter *23.02 Speed ref ramp output*. Parameter *24.01 Used speed reference* displays the final speed reference after the addition of speed trim.

#### Torque trim connection

Torque trim is added to parameter *26.75 Torque reference act 5*. Parameter *26.76 Torque reference act 6* displays the final torque reference after the addition of torque trim.

#### Frequency trim connection

Frequency trim is added to parameter *28.02 Frequency ref ramp output* and generates the final frequency after the trim addition. At present, no parameter displays the final frequency reference after the addition of frequency trim.

#### Settings and diagnostics

Parameter groups: *40 Process PID set 1*, especially parameters *40.51...40.56* (page *364*) and *41 Process PID set 2*, especially parameters *41.51...41.56* (page *370*).

Events: -

---

## ■ Pump and fan control (PFC)

The Pump and fan control (PFC) is used in pump or fan systems consisting of one drive and multiple pumps or fans. The drive controls the speed of one of the pumps/fans and in addition connects (and disconnects) the other pumps/fans directly to the supply network through contactors.

The PFC control logic switches auxiliary motors on and off as required by the capacity changes of the process. In a pump application for example, the drive controls the motor of the first pump, varying the motor speed to control the output of the pump. This pump is the speed regulated pump. When the demand (represented by the process PID reference) exceeds the capacity of the first pump (a user defined speed/frequency limit), the PFC logic automatically starts an auxiliary pump. The logic also reduces the speed of the first pump, controlled by the drive, to account for the addition to the total system output by the auxiliary pump. Then, as before, the PID controller adjusts the speed/frequency of the first pump in such a way that the system output meets the process needs. If the demand continues to increase, the PFC logic adds further auxiliary pumps, in a similar manner as just described.

As the demand drops, making the speed of the first pump fall below a minimum limit (user defined as a speed/frequency limit), the PFC logic automatically stops an auxiliary pump. The PFC logic also increases the speed of the drive controlled pump to account for the missing output of the stopped auxiliary pump.

The Pump and fan control (PFC) is supported in external control location EXT2 only.

**Example:** Three-pump constant pressure water supply application

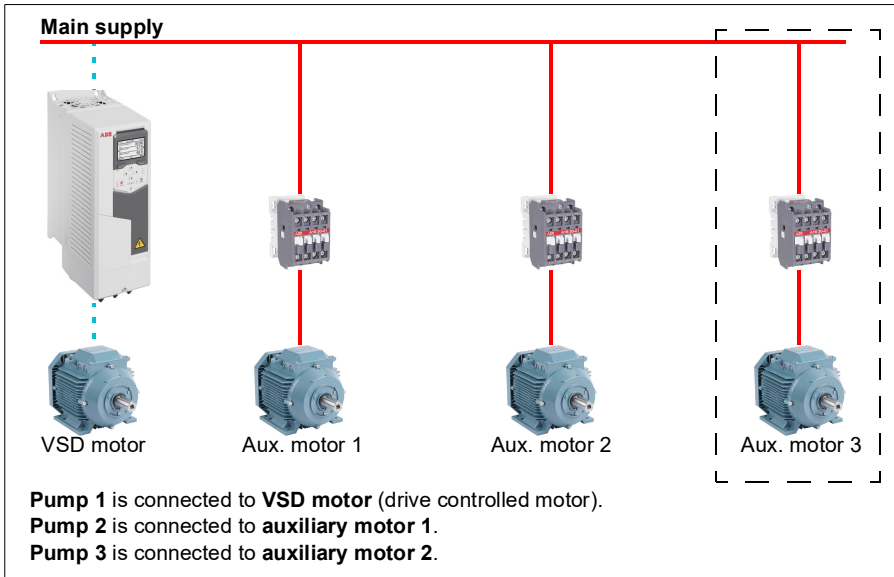

Flow consumption vs. pump status			
Consumption	Pump 1	Pump 2	Pump 3
Low	VSD	Off	Off
↓	VSD	DOL	Off
High	VSD	DOL	DOL
↓	VSD	DOL	Off
Low	VSD	Off	Off

**VSD** = Controlled by drive, tuning the output speed according to PID control.

**DOL** = Direct On Line. Pump is running at fixed motor nominal speed.

**Off** = Off-line. Pump stops.

### Soft pump and fan control (SPFC)

The Soft pump and fan control (SPFC) logic is a variant of the PFC logic for pump and fan alternation applications where lower pressure peaks are desirable when a new auxiliary motor is to be started. The SPFC logic is an easy way to implement soft starting of direct on line (auxiliary) motors.

The main difference between traditional PFC and SPFC logic is how the SPFC logic connects auxiliary motors on-line. When the criteria for starting a new motor is fulfilled (see above) the SPFC logic connects the drive controlled motor to the supply network in a flying start, that is, while the motor is still coasting. The drive then connects to the next pump/fan unit to be started and starts controlling the speed of that one, while the previously controlled unit is now connected directly on line through a contactor.

Further (auxiliary) motors are started in a similar manner. The motor stopping routine is the same as for the normal PFC routine.

In some cases SPFC makes it possible to soften the start-up current while connecting auxiliary motors on-line. Lower pressure peaks on the pipelines and pumps may be achieved as a result.

**Example:** Three-pump constant pressure water supply application

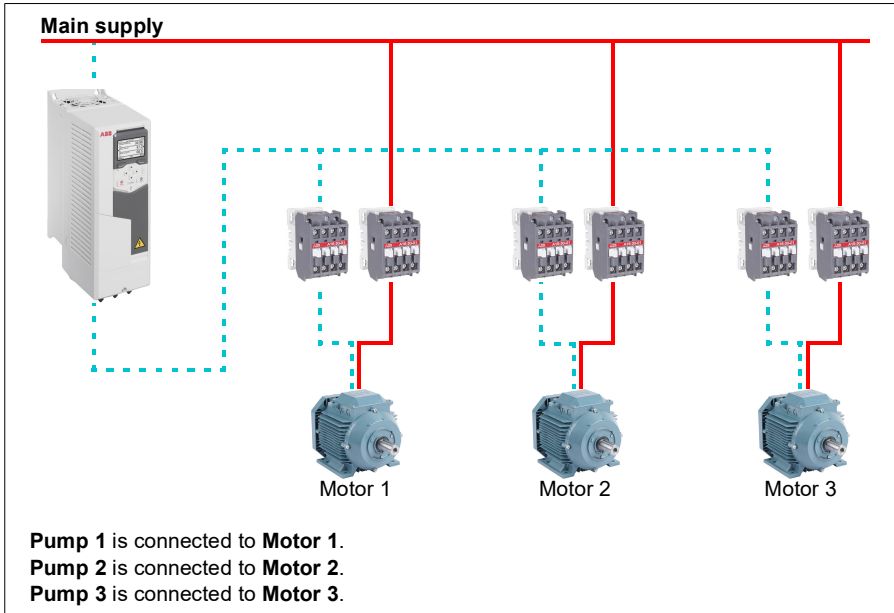

Flow consumption and pump status			
Consumption	Pump 1	Pump 2	Pump 3
Low	VSD	Off	Off
↓	DOL	VSD	Off
High	DOL	DOL	VSD
↓	DOL	Off	VSD
Low	Off	Off	VSD
↓	VSD	Off	DOL
High	DOL	VSD	DOL
↓	DOL	VSD	Off
Low	Off	VSD	Off
↓	VSD	DOL	Off
High	DOL	DOL	VSD

**VSD** = Controlled by drive, tuning the output speed according to PID control.

**DOL** = Direct On Line. Pump is running at fixed motor nominal speed.

**Off** = Off-line. Pump stops.



## **Autochange**

Automatic rotation of the start order, or Autochange functionality, serves two main purposes in many PFC type setups. One is to keep the run times of the pumps/fans equal over time to even their wear. The other is to prevent any pump/fan from standing still for too long, which would clog up the unit. In some cases it is desirable to rotate the start order only when all units are stopped, for example to minimize the impact on the process.

The Autochange can also be triggered by the Timed function (see page [156](#)).

There are three modes of autochange according to what kind of PFC and SPFC together with auxiliary circuit are implemented.

### 1. Autochange PFC with auxiliary motors only

**Example:** Three-pump constant pressure water supply application

Two pumps fulfill the flow consumption for long term running, and the third pump is reserved for shifting. In this mode, only two auxiliary motors, pump 2 and pump 3, shift working.

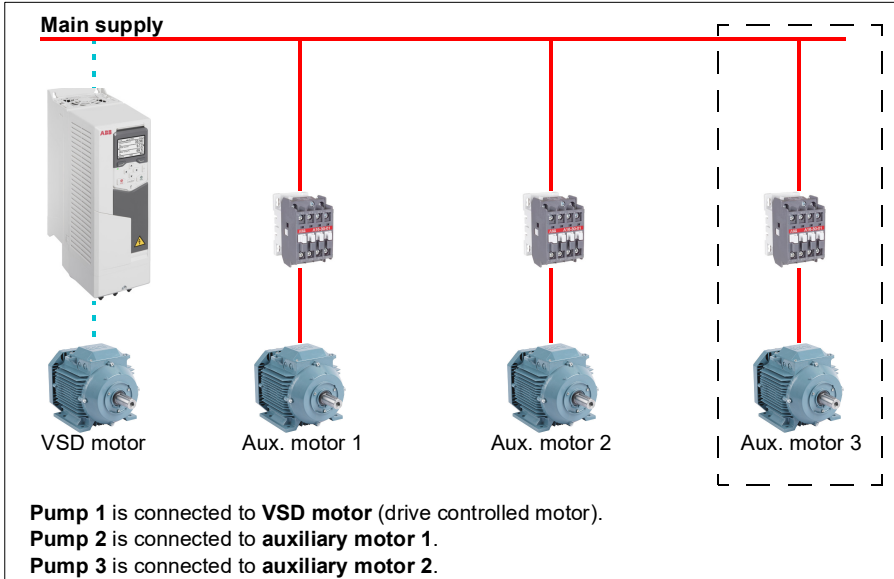

Flow consumption and pump status			
Consumption	Pump 1	Pump 2	Pump 3
Low	VSD	Off	Off
Normal	VSD	DOL	Off
↓	VSD	Off	DOL
↓	VSD	DOL	Off
Normal	VSD	Off	DOL

**VSD** = Controlled by drive, tuning the output speed according to PID control.

**DOL** = Direct On Line. Pump is running at fixed motor nominal speed.

**Off** = Off-line. Pump stops.

## 2. Autochange PFC with all motors

**Example:** Three-pump constant pressure water supply application

Two pumps fulfill the flow consumption for long term running, and the third pump is reserved for shifting. Because all motors will be shifted for autochange routine, special auxiliary circuit is needed, which is the same as for the SPFC system.

In this mode, the VSD motor will move to the next pump one by one, but the auxiliary motor will always be put on-line in DOL mode. However, three pumps are shifted overall.

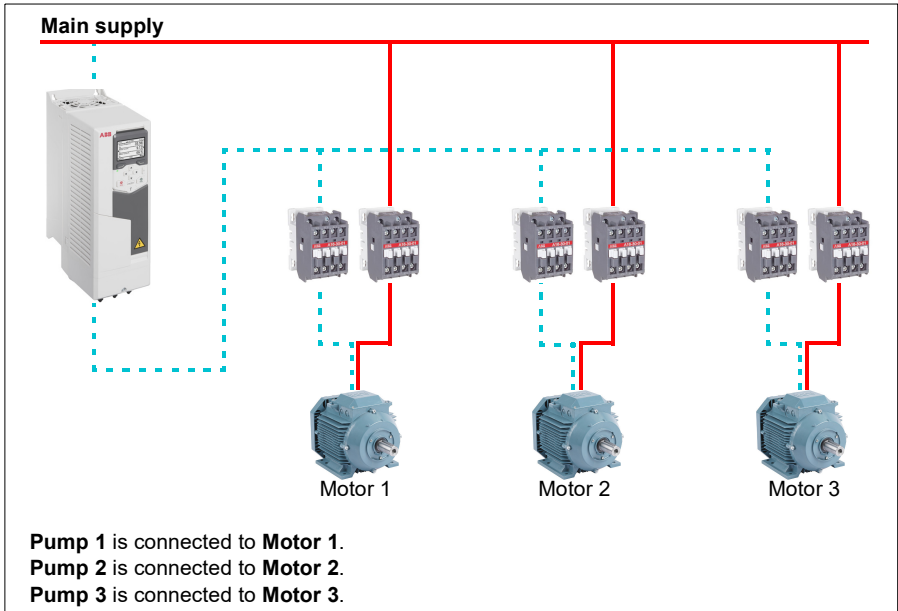

Flow consumption and pump status			
Consumption	Pump 1	Pump 2	Pump 3
Low	VSD	Off	Off
Normal	VSD	DOL	Off
↓	Off	VSD	DOL
↓	DOL	Off	VSD
Normal	VSD	DOL	Off

**VSD** = Controlled by drive, tuning the output speed according to PID control.

**DOL** = Direct On Line. Pump is running at fixed motor nominal speed.

**Off** = Off-line. Pump stops.

### 3. Autochange with SPFC

Auxiliary motor is meaningless in SPFC. So it does not matter if you select All motors or Aux motor only.

**Example:** Three-pump constant pressure water supply application

Two pumps fulfill the flow consumption for long term running, and the third pump is reserved for shifting.

SPFC system supports autochange naturally. No extra component is needed as long as SPFC is already working there. In this mode, all the pumps are always started by the drive as they are in SPFC normal operation.

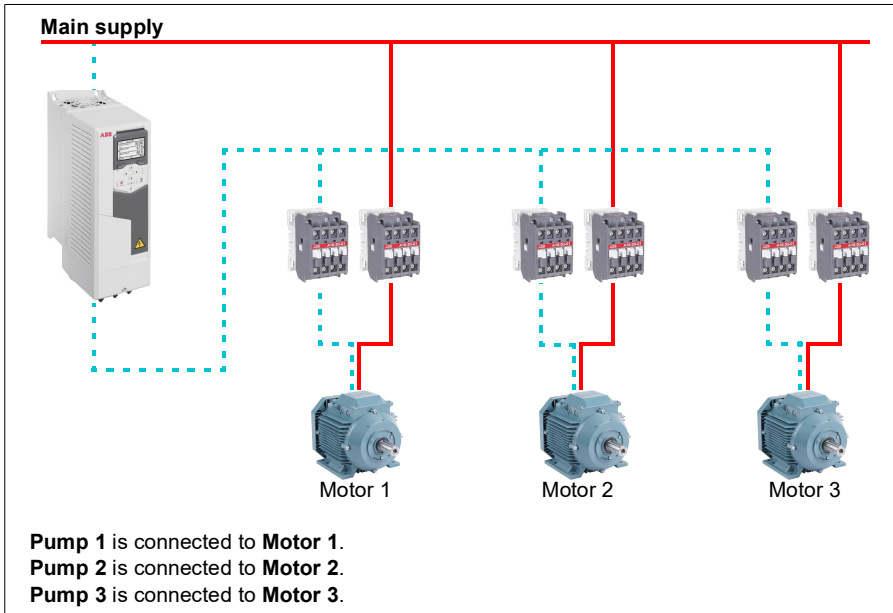

Flow consumption and pump status			
Consumption	Pump 1	Pump 2	Pump 3
Low	VSD	Off	Off
Normal	DOL	VSD	Off
↓	Off	DOL	VSD
↓	VSD	Off	DOL
Normal	DOL	VSD	Off

**VSD** = Controlled by drive, tuning the output speed according to PID control.

**DOL** = Direct On Line. Pump is running at fixed motor nominal speed.

**Off** = Off-line. Pump stops.

## Interlock

There is an option to define interlock signals for each motor in the PFC system. When the interlock signal of a motor is Available, the motor participates in the PFC starting sequence. If the signal is Interlocked, the motor is excluded. This feature can be used for informing the PFC logic that a motor is not available (for example due to maintenance or manual direct-on-line starting).

### Settings and diagnostics

Parameter: [96.04 Macro select](#) (page 417) (macro selection).

Parameter groups: [10 Standard DI, RO](#) (page 216), [40 Process PID set 1](#) (page 353), [76 PFC configuration](#) (page 403) and [77 PFC maintenance and monitoring](#) (page 411).

Events: [D501 No more available PFC motors](#) (page 492), [D502 All motors interlocked](#) (page 492), [D503 VSD controlled PFC motor interlocked](#) (page 492).

## ■ Timed functions

A Timer can be active based on time of the day, day of the week and season of the year. In addition to these time related parameters, the Timer activation can be influenced by so called exceptional days (configurable as holiday or workday). A Timer can be set to be active or inactive during the exceptional days.

Several Timers can be connected to a Timed function with the OR function. Thus if any of the Timers connected to a Timed function is active, the Timed function is also active. Timed function is then in turn controlling normal drive functions like starting the drive, choosing the right speed or right setpoint for the PID loop controller.

In many cases where a fan or pump is controlled with a Timed function, it is often required that there is a possibility to override the time program for a short while. The overriding functionality is called Boost. The Boost is directly affecting selected Timed function(s) and switches it (them) on for a predefined time. The Boost mode is typically activated through a digital input and its operation time is set in parameters.

A diagram illustrating the relations of the Timed functions entities is shown below.

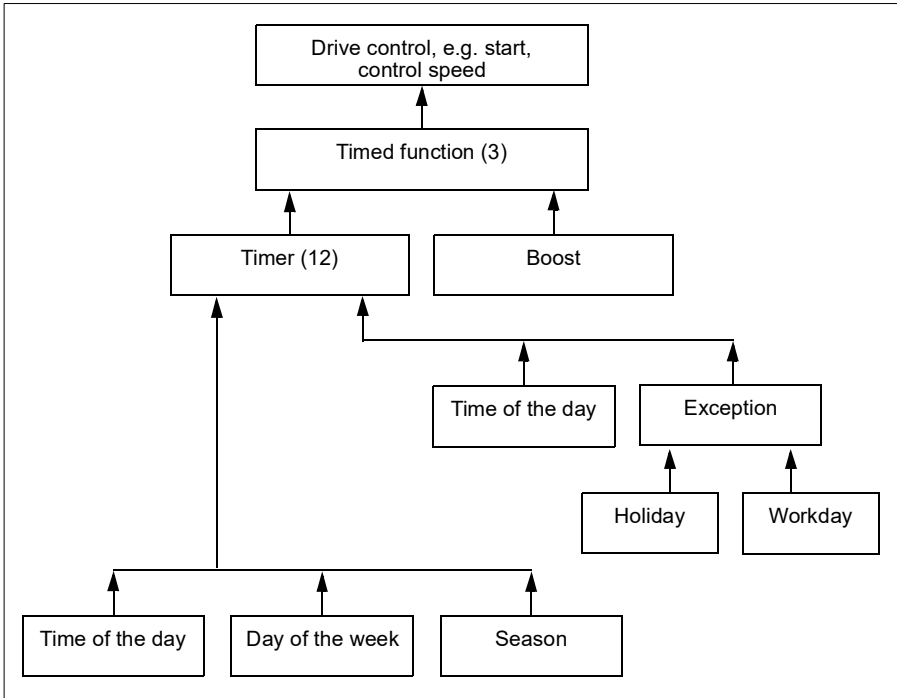

### Settings and diagnostics

Parameter group: [34 Timed functions](#) (page [327](#)).

Events: -

### ■ Motor potentiometer

The motor potentiometer is, in effect, a counter whose value can be adjusted up and down using two digital signals selected by parameters [22.73 Motor potentiometer up source](#) and [22.74 Motor potentiometer down source](#).

When enabled by [22.71 Motor potentiometer function](#), the motor potentiometer assumes the value set by [22.72 Motor potentiometer initial value](#). Depending on the mode selected in [22.71](#), the motor potentiometer value is either retained or reset over a power cycle.

The change rate is defined in [22.75 Motor potentiometer ramp time](#) as the time it would take for the value to change from the minimum ([22.76 Motor potentiometer min value](#)) to the maximum ([22.77 Motor potentiometer max value](#)) or vice versa. If the up and down signals are simultaneously on, the motor potentiometer value does not change.



### Settings and diagnostics

Parameters: [20.04 Ext2 in2 source](#) (page 249) and [22.71 Motor potentiometer function ...22.80 Motor potentiometer ref act](#) (page 274).

Events: -

### ■ Mechanical brake control

A mechanical brake can be used for holding the motor and driven machinery at zero speed when the drive is stopped, or not powered. The brake control logic observes the settings of parameter group [44 Mechanical brake control](#) as well as several external signals, and moves between the states presented in the diagram on page [153](#). The tables below the state diagram detail the states and transitions. The timing diagram on page [154](#) shows an example of a close-open-close sequence.

### Inputs of the brake control logic

The start command of the drive (bit 5 of [06.16 Drive status word 1](#)) is the main control source of the brake control logic.

### Outputs of the brake control logic

The mechanical brake is to be controlled by bit 0 of parameter [44.01 Brake control status](#). This bit should be selected as the source of a relay output (or a digital input/output in output mode) which is then wired to the brake actuator through a relay. See the wiring example on page [155](#).

The brake control logic, in various states, will request the drive control logic to hold the motor or ramp down the speed. These requests are visible in parameter [44.01 Brake control status](#).

### Settings and diagnostics

Parameter group: [44 Mechanical brake control](#) (page 373).

Parameters: [06.16 Drive status word 1](#) (page 210) and [44.01 Brake control status](#) (page 373).

Event: [A7A2 Mechanical brake opening failed](#) (page 488).

---



### Brake state diagram

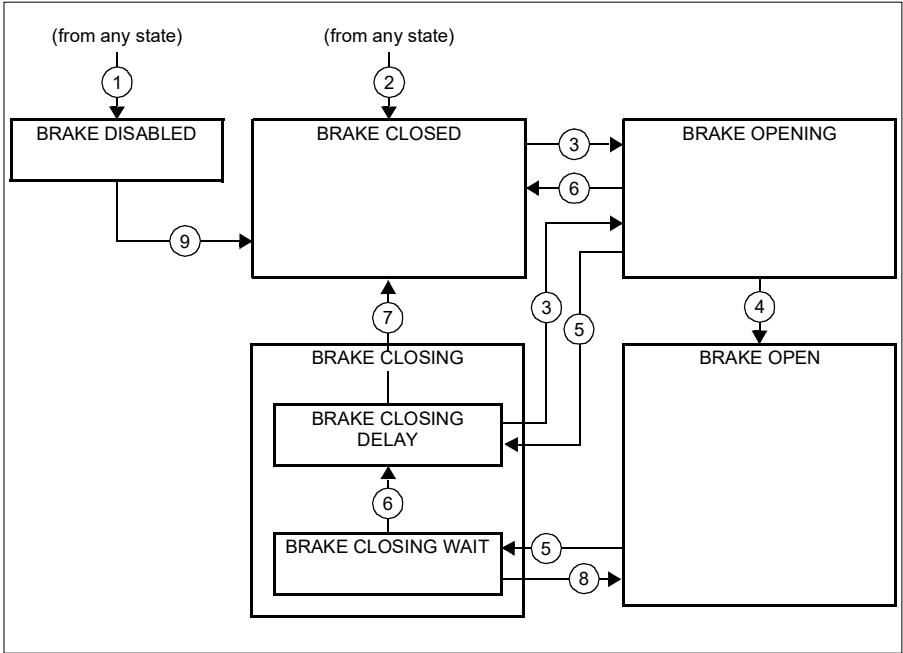

### State descriptions

State name	Description
<i>BRAKE DISABLED</i>	Brake control is disabled (parameter <a href="#">44.06 Brake control enable</a> = 0, and <a href="#">44.01 Brake control status</a> b4 = 0). The open signal is active ( <a href="#">44.01 Brake control status</a> b0 = 1).
<i>BRAKE OPENING:</i>	Brake has been requested to open. ( <a href="#">44.01 Brake control status</a> b2 = 1). Open signal has been activated ( <a href="#">44.01 Brake control status</a> b0 is set). The load is held in place by the speed control of the drive until <a href="#">44.08 Brake open delay</a> elapses.
<i>BRAKE OPEN</i>	The brake is open ( <a href="#">44.01 Brake control status</a> b0 = 1). Hold request is removed ( <a href="#">44.01 Brake control status</a> b2 = 0), and the drive is allowed to follow the reference.
<i>BRAKE CLOSING:</i>	
<i>BRAKE CLOSING WAIT</i>	Brake has been requested to close. The drive logic is requested to ramp down the speed to a stop ( <a href="#">44.01 Brake control status</a> b3 = 1). The open signal is kept active ( <a href="#">44.01 Brake control status</a> b0 = 1). The brake logic will remain in this state until the motor speed is below <a href="#">44.14 Brake close level</a> .
<i>BRAKE CLOSING DELAY</i>	Closing conditions have been met. The open signal is deactivated ( <a href="#">44.01 Brake control status</a> b0 → 0). The ramp-down request is maintained ( <a href="#">44.01 Brake control status</a> b3 = 1). The brake logic will remain in this state until <a href="#">44.13 Brake close delay</a> has elapsed. At this point, the logic proceeds to <i>BRAKE CLOSED</i> state.
<i>BRAKE CLOSED</i>	The brake is closed ( <a href="#">44.01 Brake control status</a> b0 = 0). The drive is not necessarily modulating.

State change conditions ( n )

- 1 Brake control disabled (parameter [44.06 Brake control enable](#) → 0).
- 2 [06.11 Main status word](#), bit 2 = 0.
- 3 Brake has been requested to open.
- 4 [44.08 Brake open delay](#) has elapsed.
- 5 Brake has been requested to close.
- 6 Motor speed is below closing speed [44.14 Brake close level](#).
- 7 [44.13 Brake close delay](#) has elapsed.
- 8 Brake has been requested to open.
- 9 Brake control enabled (parameter [44.06 Brake control enable](#) → 1).

**Timing diagram**

The simplified timing diagram below illustrates the operation of the brake control function. Refer to the state diagram above.

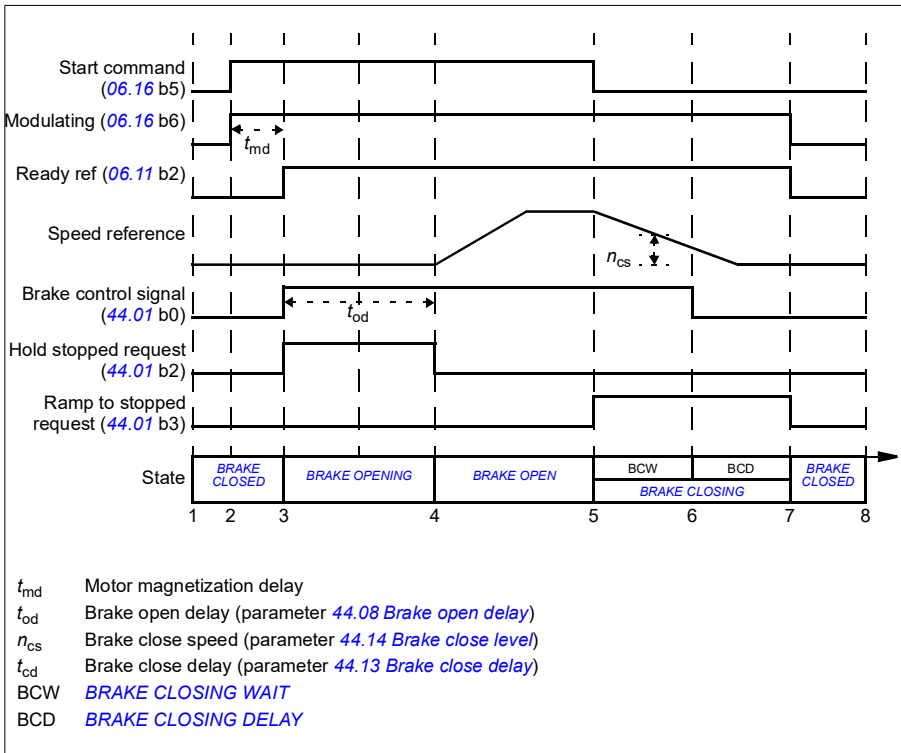

## Wiring example

The figure below shows a brake control wiring example. The brake control hardware and wiring is to be sourced and installed by the customer.



**WARNING!** Make sure that the machinery into which the drive with brake control function is integrated fulfils the personnel safety regulations. Note that the frequency converter (a Complete Drive Module or a Basic Drive Module, as defined in IEC/EN 61800-2), is not considered as a safety device mentioned in the European Machinery Directive and related harmonised standards. Thus, the personnel safety of the complete machinery must not be based on a specific frequency converter feature (such as the brake control function), but it has to be implemented as defined in the application specific regulations.

The brake is controlled by bit 0 of parameter [44.01 Brake control status](#). In this example, parameter [10.24 RO1 source](#) is set to [Brake command](#) (ie. bit 0 of [44.01 Brake control status](#)).

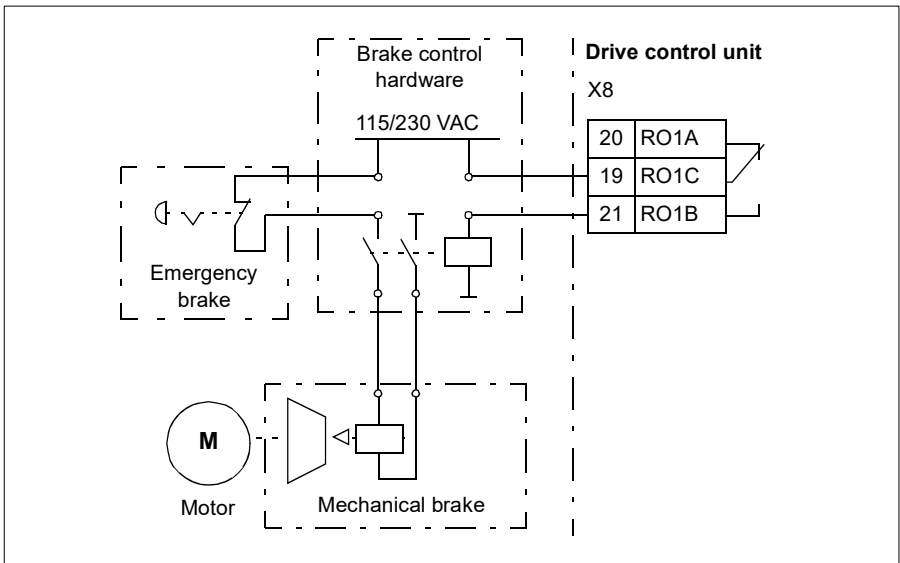

## Motor control

### ■ Motor types

The drive supports asynchronous AC induction, permanent magnet (PM) and synchronous reluctance motors (SynRM).

### ■ Motor identification

The performance of vector control is based on an accurate motor model determined during the motor start-up.

A motor Identification magnetization is automatically performed the first time the start command is given. During this first start-up, the motor is magnetized at zero speed for several seconds and the motor and motor cable resistance are measured to allow the motor model to be created. This identification method is suitable for most applications.

In demanding applications a separate Identification run (ID run) can be performed.

#### Settings and diagnostics

Parameter: [99.13 ID run requested](#) (page 434).

Events: [AFF6 Identification run](#) (page 492) and [FF61 ID run](#) (page 503).

### ■ Scalar motor control

Scalar motor control is the default motor control method. In scalar control mode, the drive is controlled with a frequency reference. However, the excellent performance of vector control is not achieved in scalar control.

ABB recommends to activate scalar motor control mode in the following situations:

- If the exact nominal motor values are not available or the drive needs to run different motor after the commissioning phase
- If a short commissioning time is needed or no ID run is wanted
- In multimotor systems: 1) if the load is not equally shared between the motors, 2) if the motors are of different sizes, or 3) if the motors are going to be changed after motor identification (ID run)
- If the nominal current of the motor is less than 1/6 of the nominal output current of the drive
- If the drive is used without a motor connected (for example, for test purposes)
- If the drive runs a medium-voltage motor through a step-up transformer.
- If the drive is equipped with a sine filter.

In scalar control, some standard features are not available.

See also section [Operating modes of the drive](#) (page 112).

---

## IR compensation for scalar motor control

IR compensation (also known as voltage boost) is available only when the motor control mode is scalar. When IR compensation is activated, the drive gives an extra voltage boost to the motor at low speeds. IR compensation is useful in applications, such as positive displacement pumps, that require a high break-away torque.

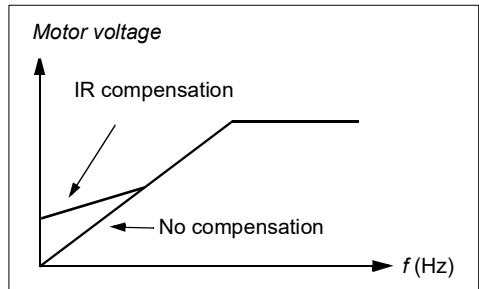

In vector control, no IR compensation is possible or needed as it is applied automatically.

### Settings and diagnostics

#### **Menu - Primary settings - Motor - IR compensation**

Parameter group: [28 Frequency reference chain](#) (page 290).

Parameters: [97.13 IR compensation](#) (page 428) and [99.04 Motor control mode](#) (page 431).

Events: -

### ■ **Vector motor control**

Vector control is the motor control mode that is intended for applications where high control accuracy is needed. It offers better control over the whole speed range, in particular in applications where slow speed with high torque is needed. It requires an identification run at startup. Vector control cannot be used in all applications, for example, when sine filters are being used or there are multiple motors connected to single drive.

The switching of the output semiconductors is controlled to achieve the required stator flux and motor torque. The reference value for the torque controller comes from the speed controller or directly from an external torque reference source.

Stator flux is calculated by integrating the motor voltage in vector space. Rotor flux can be calculated from stator flux and the motor model. Motor torque is produced by controlling current 90 degrees from the rotor flux. By utilizing the identified motor model, the rotor flux estimate is improved. Actual motor shaft speed is not needed for the motor control.

Vector control is required when using synchronous reluctance motors (SynRM).

See also section [Speed compensated stop](#) (page 168).

Settings and diagnostics

**Menu - Primary settings - Motor - Control mode**

Parameters: [99.04 Motor control mode](#) (page 431) and [99.13 ID run requested](#) (page 434).

Events: -

**Speed control performance figures**

The table below shows typical performance figures for speed control.

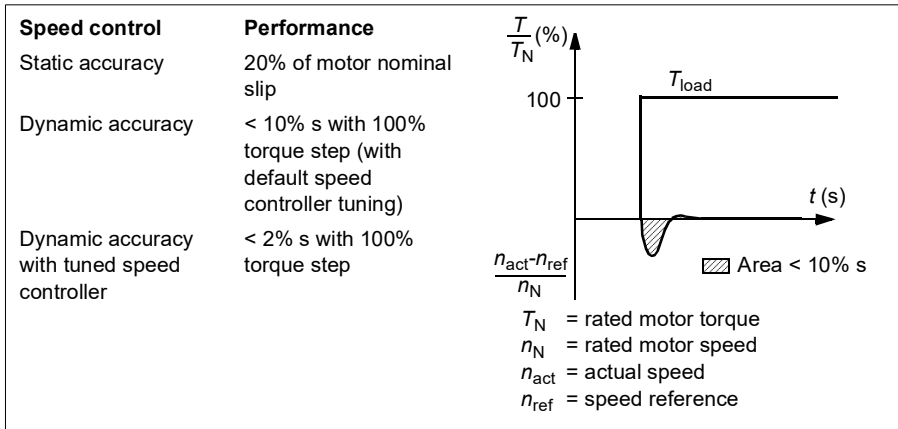

Settings and diagnostics

Parameter group: [25 Speed control](#) (page 280).

Events: -

## Torque control performance figures

The drive can perform precise torque control without any speed feedback from the motor shaft. The table below shows typical performance figures for torque control.

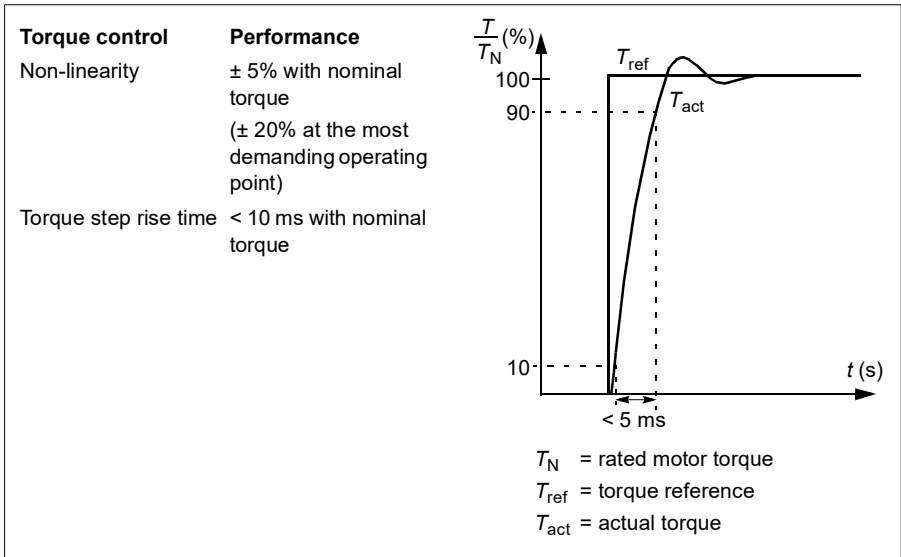

## Power loss ride-through

See section [Undervoltage control \(power loss ride-through\)](#) on page 169.

## U/f ratio

The U/f function is only available in scalar motor control mode, which uses frequency control.

The function has two modes: linear and squared.

In linear mode, the ratio of voltage to frequency is constant below the field weakening point. This is used in constant torque applications where it may be necessary to produce torque at or near the rated torque of the motor throughout the frequency range.

In squared mode (default), the ratio of the voltage to frequency increases as the square of the frequency below the field weakening point. This is typically used in centrifugal pump or fan applications. For these applications, the torque required follows the square relationship with frequency. Therefore, if the voltage is varied using the square relationship, the motor operates at improved efficiency and lower noise levels in these applications.

The U/f function cannot be used with energy optimization; if parameter [45.11 Energy optimizer](#) is set to [Enable](#), parameter [97.20 U/F ratio](#) is ignored.

Settings and diagnostics**Menu - Primary settings - Motor - U/f ratio**

Parameters: [45.11 Energy optimizer](#) (page 377) and [97.20 U/F ratio](#) (page 428).

Events: -

### ■ Flux braking

The drive can provide greater deceleration by raising the level of magnetization in the motor. By increasing the motor flux, the energy generated by the motor during braking can be converted to motor thermal energy.

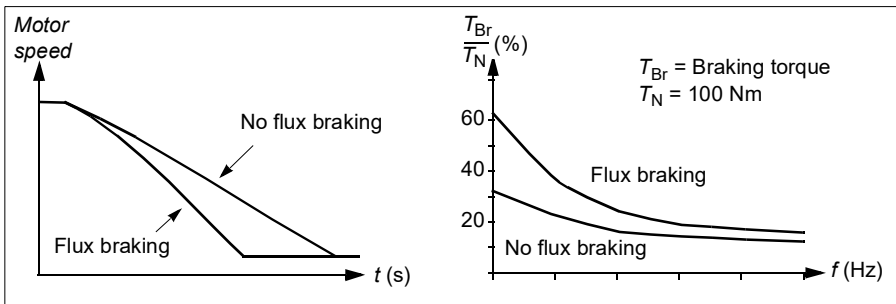

The drive monitors the motor status continuously, also during flux braking. Therefore, flux braking can be used both for stopping the motor and for changing the speed. The other benefits of flux braking are:

- The braking starts immediately after a stop command is given. The function does not need to wait for the flux reduction before it can start the braking.
- The cooling of the induction motor is efficient. The stator current of the motor increases during flux braking, not the rotor current. The stator cools much more efficiently than the rotor.
- Flux braking can be used with induction motors and permanent magnet synchronous motors.

Two braking power levels are available:

- Moderate braking provides faster deceleration compared to a situation where flux braking is disabled. The flux level of the motor is limited to prevent excessive heating of the motor.
- Full braking exploits almost all available current to convert the mechanical braking energy to motor thermal energy. Braking time is shorter compared to moderate braking. In cyclic use, motor heating may be significant.



**WARNING:** The motor needs to be rated to absorb the thermal energy generated by flux braking.



## Settings

### **Menu - Primary settings - Motor - Flux braking**

Parameter: [97.05 Flux braking](#) (page [426](#)).

Events: -

### **■ DC magnetization**

The drive has different magnetization functions for different phases of motor start/rotation/stop: pre-magnetization, DC hold, post-magnetization and pre-heating (motor heating).

#### **Pre-magnetization**

Pre-magnetization refers to DC magnetization of the motor before start. Depending on the selected start mode ([21.01 Start mode](#) or [21.19 Scalar start mode](#)), pre-magnetization can be applied to guarantee the highest possible breakaway torque, up to 200% of the nominal torque of the motor. By adjusting the pre-magnetization time ([21.02 Magnetization time](#)), it is possible to synchronize the motor start and, for example, the release of a mechanical brake.

#### Settings and diagnostics

Parameters: [21.01 Start mode](#) (page [257](#)), [21.02 Magnetization time](#) (page [258](#)) and [21.19 Scalar start mode](#) (page [262](#)).

Events: -

---

## DC hold

The function makes it possible to lock the rotor at (near) zero speed in the middle of normal operation. DC hold is activated by parameter [21.08 DC current control](#). When both the reference and motor speed drop below a certain level (parameter [21.09 DC hold speed](#)), the drive will stop generating sinusoidal current and start to inject DC into the motor. The current is set by parameter [21.10 DC current reference](#). When the reference exceeds parameter [21.09 DC hold speed](#), normal drive operation continues.

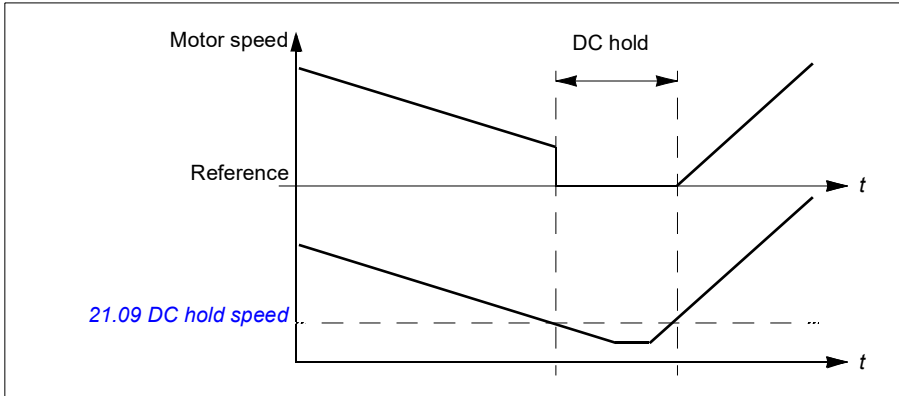

### Settings and diagnostics

Parameters: [21.08 DC current control](#) (page 261) and [21.09 DC hold speed](#) (page 261).

Events: -

## Post-magnetization

The function keeps the motor magnetized for a certain period (parameter [21.11 Post magnetization time](#)) after stopping. This is to prevent the machinery from moving under load, for example before a mechanical brake can be applied. Post-magnetization is activated by parameter [21.08 DC current control](#). The magnetization current is set by parameter [21.10 DC current reference](#).

**Note:** Post-magnetization is only available when ramp stop is selected (see parameter [21.03 Stop mode](#)).

### Settings and diagnostics

Parameters: [21.03 Stop mode](#) (page 258), [21.08 DC current control](#) (page 261) and [21.11 Post magnetization time](#) (page 261).

Events: -

## Pre-heating (Motor heating)

The pre-heating function keeps the motor warm and prevents condensation inside the motor by feeding it with DC current when the drive has been stopped. The heating can only be on when the drive is in the stopped state, and starting the drive stops the heating.

When pre-heating is activated and the stop command is given, pre-heating starts immediately if the drive is running below the zero speed limit (see bit 0 in parameter [06.19 Speed control status word](#)). If the drive is running above the zero speed limit, pre-heating is delayed by the time defined by parameter [21.15 Pre-heating time delay](#) to prevent excessive current.

The function can be defined to be always active when the drive is stopped or it can be activated by a digital input, fieldbus, timed function or supervision function. For example, with the help of signal supervision function, the heating can be activated by a thermal measurement signal from the motor.

The pre-heating current fed to the motor can be defined as 0...30% of the nominal motor current.

When the pre-heating is active, an icon is shown on the status bar to indicate that current is being fed to the motor, see page [44](#).

### Notes:

- In applications where the motor keeps rotating for a long time after the modulation is stopped, ABB recommends to use ramp stop with pre-heating to prevent a sudden pull at the rotor when the pre-heating is activated.
- The heating function requires that the STO circuit is closed or not triggered open.
- The heating function requires that the drive is not faulted.
- The heating function is allowed even if Enable to rotate signal is missing.
- The heating function is allowed even if Start enable signal is missing.
- Pre-heating uses DC hold to produce current.

### Settings and diagnostics

#### Menu - Primary settings - Motor - Pre-heating

Parameters: [21.14 Pre-heating input source](#) (page [261](#)), [21.15 Pre-heating time delay](#) (page [262](#)) and [21.16 Pre-heating current](#) (page [262](#)).

Events: -

---

## ■ Energy optimization

The function optimizes the motor flux so that total energy consumption and motor noise level are reduced when the drive operates below the nominal load. The total efficiency (motor and drive) can be improved by 1...20% depending on load torque and speed.

**Note:** With permanent magnet and synchronous reluctance motors, energy optimization is always enabled.

### Settings and diagnostics

#### **Menu - Energy efficiency**

Parameter: [45.11 Energy optimizer](#) (page 377).

Events: -

## ■ Switching frequency

The drive has two switching frequencies: reference switching frequency and minimum switching frequency. The drive tries to keep the highest allowed switching frequency (= reference switching frequency) if thermally possible, and then adjusts dynamically between the reference and minimum switching frequencies depending on the drive temperature. When the drive reaches the minimum switching frequency (= lowest allowed switching frequency), it starts to limit output current as the heating up continues.

For derating, see chapter *Technical data*, section *Switching frequency derating* in the *Hardware manual* of the drive.

**Example 1:** If you need to fix the switching frequency to a certain value as with some external filters, for example, with EMC C1 or sine filters (see the *Hardware manual of the drive*), set both the reference and the minimum switching frequency to this value and the drive will retain this switching frequency.

**Example 2:** If the reference switching frequency is set to 12 kHz and the minimum switching frequency is set to the smallest available value, the drive maintains the highest possible switching frequency to reduce motor noise and only when the drive heats it will decrease the switching frequency. This is useful, for example, in applications where low noise is necessary but higher noise can be tolerated when the full output current is needed.

### Settings and diagnostics

Parameters: [97.01 Switching frequency reference](#) and [97.02 Minimum switching frequency](#) (page 412).

Events: -

---

## Rush control

In torque control, the motor could potentially rush if the load were suddenly lost. The control program has a rush control function that decreases the torque reference whenever the motor speed exceeds [30.11 Minimum speed](#) or [30.12 Maximum speed](#).

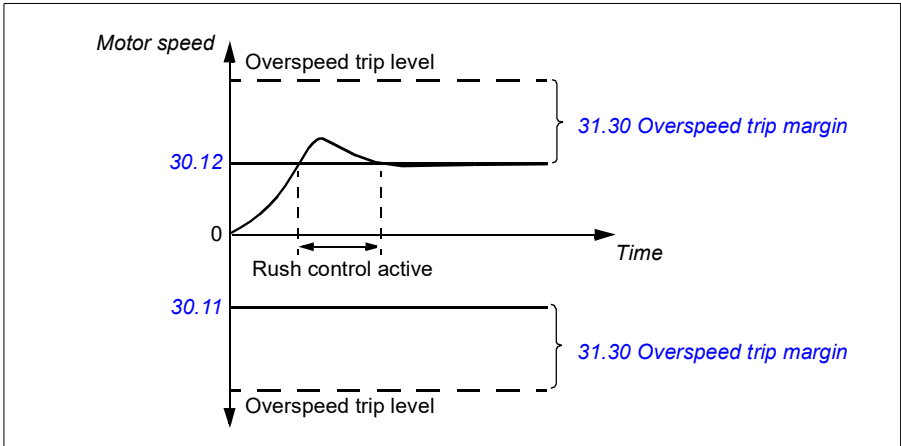

The function is based on a PI controller. The proportional gain and integration time can be defined by parameters. Setting these to zero disables rush control.

### Settings and diagnostics

Parameters: [25.02 Speed proportional gain](#) (page 281), [25.03 Speed integration time](#) (page 281), [30.11 Minimum speed](#) (page 303), [30.12 Maximum speed](#) (page 303) and [31.30 Overspeed trip margin](#) (page 307).

Events: -

## Jogging

The jogging function enables the use of a momentary switch to briefly rotate the motor. The jogging function is typically used during servicing or commissioning to control the machinery locally.

Two jogging functions (1 and 2) are available, each with their own activation sources and references. The signal sources are selected by parameters [20.26 Jogging 1 start source](#) and [20.27 Jogging 2 start source](#) (**Menu - Primary settings - Start, stop, reference - Jogging**). When jogging is activated, the drive starts and accelerates to the defined jogging speed ([22.42 Jogging 1 ref](#) or [22.43 Jogging 2 ref](#)) along the defined jogging acceleration ramp ([23.20 Acc time jogging](#)). After the activation signal switches off, the drive decelerates to a stop along the defined jogging deceleration ramp ([23.21 Dec time jogging](#)).

The figure and table below provide an example of how the drive operates during jogging. In the example, the ramp stop mode is used (see parameter [21.03 Stop mode](#)).

Jog cmd = State of source set by [20.26 Jogging 1 start source](#) or [20.27 Jogging 2 start source](#)

Jog = State of source set by [20.25 Jogging enable](#)

Start cmd = State of drive start command.

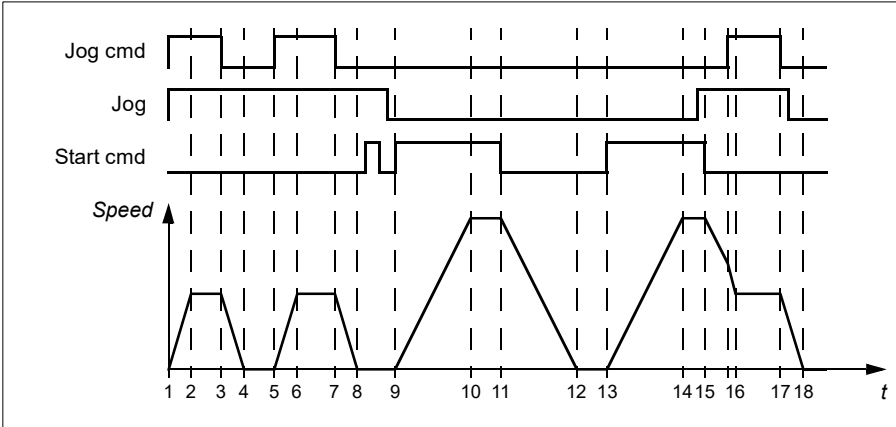

Phase	Jog cmd	Jog	Start cmd	Description
1-2	1	1	0	Drive accelerates to the jogging speed along the acceleration ramp of the jogging function.
2-3	1	1	0	Drive follows the jog reference.
3-4	0	1	0	Drive decelerates to zero speed along the deceleration ramp of the jogging function.
4-5	0	1	0	Drive is stopped.
5-6	1	1	0	Drive accelerates to the jogging speed along the acceleration ramp of the jogging function.
6-7	1	1	0	Drive follows the jog reference.
7-8	0	1	0	Drive decelerates to zero speed along the deceleration ramp of the jogging function.
8-9	0	1->0	0	Drive is stopped. As long as the jog signal is on, start commands are ignored. After jog switches off, a fresh start command is required.
9-10	x	0	1	Drive accelerates to the speed reference along the selected acceleration ramp (parameters <a href="#">23.11...23.15</a> ).
10-11	x	0	1	Drive follows the speed reference.
11-12	x	0	0	Drive decelerates to zero speed along the selected deceleration ramp (parameters <a href="#">23.11...23.15</a> ).

Phase	Jog cmd	Jog	Start cmd	Description
12-13	x	0	0	Drive is stopped.
13-14	x	0	1	Drive accelerates to the speed reference along the selected acceleration ramp (parameters <a href="#">23.11...23.15</a> ).
14-15	x	0->1	1	Drive follows the speed reference. As long as the start command is on, the jog signal is ignored. If the jog signal is on when the start command switches off, jogging is enabled immediately.
15-16	0->1	1	0	Start command switches off. The drive starts to decelerate along the selected deceleration ramp (parameters <a href="#">23.11...23.15</a> ). When the jog command switches on, the decelerating drive adopts the deceleration ramp of the jogging function.
16-17	1	1	0	Drive follows the jog reference.
17-18	0	1->0	0	Drive decelerates to zero speed along the deceleration ramp of the jogging function.

See also the block diagram on page [556](#).

#### Notes:

- Jogging is not available when the drive is in local control.
- Jogging cannot be enabled when the drive start command is on, or the drive started when jogging is disabled. Starting the drive after the jog switches off requires a fresh start command.



**WARNING!** If jogging is enabled and activated while the start command is on, jogging will activate as soon as the start command switches off.

---

- If both jogging functions are activated, the one that was activated first has priority.
- Jogging uses vector control.
- The inching functions activated through fieldbus (see [06.01 Main control word](#), bits 8...9) use the references and ramp times defined for jogging, but do not require the jog signal.

#### Settings and diagnostics

#### **Menu - Primary settings - Start, stop, reference - Jogging**

Parameters: [20.25 Jogging enable...20.27 Jogging 2 start source](#) (page [255](#)), [22.42 Jogging 1 ref...22.43 Jogging 2 ref](#) (page [273](#)) and [23.20 Acc time jogging...23.21 Dec time jogging](#) (page [277](#)).

Events: -

---

## ■ Speed compensated stop

Speed compensation stop is available for example for applications where a conveyer needs to travel a certain distance after receiving the stop command. At maximum speed, the motor is stopped normally along the defined deceleration ramp, after the application of a user defined delay to adjust the distance traveled. Below maximum speed, stop is delayed still more by running the drive at current speed before the motor is ramped to a stop. As shown in the figure, the distance traveled after the stop command is the same in both cases, that is, area A + area B equals area C.

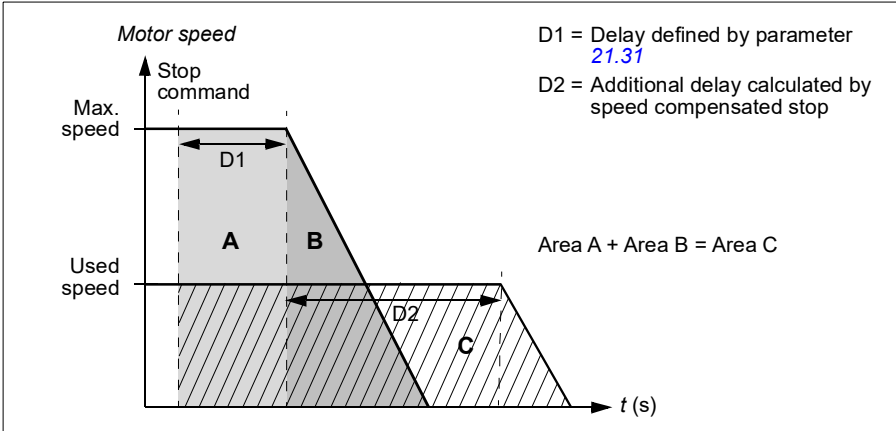

Speed compensation does not take into account shape times (parameters [23.32 Shape time 1](#) and [23.33 Shape time 2](#)). Positive shape times lengthen the distance traveled.

Speed compensation can be restricted to forward or reverse rotating direction.

Speed compensation is supported in both vector and scalar motor control.

### Settings and diagnostics

Parameters: [21.30 Speed compensated stop mode...](#)[21.32 Speed comp stop threshold](#) (page [265](#)).

Events: -



## DC voltage control

### ■ Overvoltage control

Overvoltage control of the intermediate DC link is typically needed when the motor is in generating mode. The motor can generate when it decelerates or when the load overhauls the motor shaft, causing the shaft to turn faster than the applied speed or frequency. To prevent the DC voltage from exceeding the overvoltage control limit, the overvoltage controller automatically decreases the generating torque when the limit is reached. The overvoltage controller also increases any programmed deceleration times if the limit is reached; to achieve shorter deceleration times, a brake chopper and resistor may be required.

See also section [Voltage control and trip limits](#) on page 172.

#### Settings and diagnostics

Parameter: [30.30 Overvoltage control](#) (page 307).

Events: [A3A1 DC link overvoltage](#) (page 483) and [3210 DC link overvoltage](#) (page 494).

### ■ Undervoltage control (power loss ride-through)

If the incoming supply voltage is cut off, the drive will continue to operate by utilizing the kinetic energy of the rotating motor. The drive will be fully operational as long as the motor rotates and generates energy to the drive. The drive can continue operation after the break if the main contactor (if present) remained closed.

See also section [Voltage control and trip limits](#) on page 172.

---

**Note:** Units equipped with a main contactor must be equipped with a hold circuit (for example, UPS) to keep the contactor control circuit closed during a short supply break.

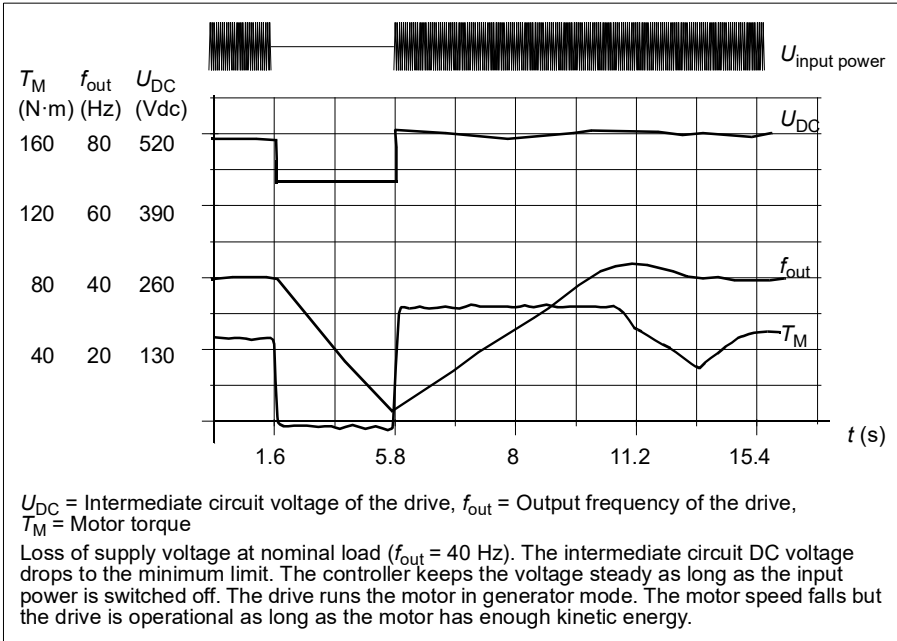

### Implementing the undervoltage control (power loss ride-through)

Implement the undervoltage control function as follows:

- Check that the undervoltage control function of the drive is enabled with parameter [30.31 Undervoltage control](#).
- Parameter [21.01 Start mode](#) must be set to *Automatic* (in vector mode) or parameter [21.19 Scalar start mode](#) to *Automatic* (in scalar mode) to make flying start (starting into a rotating motor) possible.

If the installation is equipped with a main contactor, prevent its tripping at the input power break. For example, use a time delay relay (hold) in the contactor control circuit.



**WARNING!** Make sure that the flying restart of the motor will not cause any danger. If you are in doubt, do not implement the undervoltage control function.

## Automatic restart

It is possible to restart the drive automatically after a short (max. 10 seconds) power supply failure by using the Automatic restart function, provided that the drive is allowed to run for 10 seconds without the cooling fans operating.

When enabled, the function takes the following actions upon a supply failure to a successful restart:

- The undervoltage fault is suppressed (but a warning is generated).
- Modulation and cooling is stopped to conserve any remaining energy.
- DC circuit pre-charging is enabled.

If the DC voltage is restored before the expiration of the period defined by parameter [21.18 Auto restart time](#) and the start signal is still on, normal operation will continue. However, if the DC voltage remains too low at that point, the drive trips on a fault, [3220 DC link undervoltage](#).

If parameter [21.34 Force auto restart](#) is set to *Enable*, the drive never trips on the undervoltage fault and the start signal is on forever. When the DC voltage is restored, the normal operation continues.



**WARNING!** Before you activate the function, make sure that no dangerous situations can occur. The function restarts the drive automatically and continues operation after a supply break.

---

### Settings and diagnostics

Parameters: [21.01 Start mode](#) (page 257), [21.18 Auto restart time](#)...[21.19 Scalar start mode](#) (page 262), [21.34 Force auto restart](#) (page 265) and [30.31 Undervoltage control](#) (page 307).

Events: [A3A2 DC link undervoltage](#) (page 483) and [3220 DC link undervoltage](#) (page 495).

---

## ■ Voltage control and trip limits

The control and trip limits of the intermediate DC voltage regulator are relative to the supply voltage as well as drive/inverter type. The DC voltage ( $U_{DC}$ ) is approximately 1.35 times the line-to-line supply voltage, and it is displayed by parameter [01.11 DC voltage](#).

The following tables show the values of selected DC voltage levels, for both when adaptive voltage limit is enabled by parameter [95.02 Adaptive voltage limits](#) and when adaptive voltage limit is disabled by parameter [95.02 Adaptive voltage limits](#). Note that the absolute voltages vary according to the drive/inverter type and AC supply voltage range.

### Adaptive voltage limit enabled by parameter [95.02 Adaptive voltage limits](#)

	DC voltage level [V]		
	AC supply voltage range [V] 380...415	AC supply voltage range [V] 440...480	95.01 Supply voltage = Automatic / not selected
Overvoltage fault limit	842	842	842
Overvoltage control limit	779	779	779
Internal brake chopper start limit	779	779	779
Internal brake chopper stop limit	759	759	759
Overvoltage warning limit	745	745	745
Undervoltage warning limit	$0.85 \times 1.41 \times \text{par } 95.03 \text{ value}$	$0.85 \times 1.41 \times \text{par } 95.03 \text{ value}$	$0.85 \times 1.41 \times \text{par } 95.03 \text{ value}$
Undervoltage control limit	$0.78 \times 1.41 \times \text{par } 95.03 \text{ value}$	$0.78 \times 1.41 \times \text{par } 95.03 \text{ value}$	$0.78 \times 1.41 \times \text{par } 95.03 \text{ value}$
Charging relay closing limit / Charging deactivation	$0.78 \times 1.41 \times \text{par } 95.03 \text{ value}$	$0.78 \times 1.41 \times \text{par } 95.03 \text{ value}$	$0.78 \times 1.41 \times \text{par } 95.03 \text{ value}$
Charging relay opening limit / Charging activation	$0.73 \times 1.41 \times \text{par } 95.03 \text{ value}$	$0.73 \times 1.41 \times \text{par } 95.03 \text{ value}$	$0.73 \times 1.41 \times \text{par } 95.03 \text{ value}$
DC voltage at upper bound of supply voltage range ( $U_{DCmax}$ )	560	648	(variable)
DC voltage at lower bound of supply voltage range ( $U_{DCmin}$ )	513	594	(variable)
Standby limit	$0.73 \times 1.41 \times \text{par } 95.03 \text{ value}$	$0.73 \times 1.41 \times \text{par } 95.03 \text{ value}$	$0.73 \times 1.41 \times \text{par } 95.03 \text{ value}$
Undervoltage fault limit	$0.73 \times 1.41 \times \text{par } 95.03 \text{ value}$	$0.73 \times 1.41 \times \text{par } 95.03 \text{ value}$	$0.73 \times 1.41 \times \text{par } 95.03 \text{ value}$

**Note:** Parameter [95.03 Estimated AC supply voltage](#) is the estimated AC supply voltage while powering up the drive and it will not be continuously updated during run time.

**Adaptive voltage limit disabled by parameter [95.02 Adaptive voltage limits](#)**

	DC voltage level [V]			
See <a href="#">95.01 Supply voltage</a> .	AC supply voltage range [V] 380...415	AC supply voltage range [V] 440...480	<a href="#">95.01 Supply voltage</a> = Automatic / not selected	
			If <a href="#">95.03 Estimated AC supply voltage</a> < 456 V	If <a href="#">95.03 Estimated AC supply voltage</a> > 456 V
Overvoltage fault limit	842	842	842	842
Overvoltage control limit	779	779	779	779
Internal brake chopper start limit	779	779	779	779
Internal brake chopper stop limit	759	759	759	759
Overvoltage warning limit	745	745	745	745
Undervoltage warning limit	$0.85 \times 1.35 \times 380 = 436$	$0.85 \times 1.35 \times 440 = 504$	$0.85 \times 1.35 \times 380 = 436$	$0.85 \times 1.35 \times 440 = 504$
Undervoltage control limit	$0.78 \times 1.35 \times 380 = 400$	$0.78 \times 1.35 \times 440 = 463$	$0.78 \times 1.35 \times 380 = 400$	$0.78 \times 1.35 \times 440 = 463$
Charging relay closing limit / Charging deactivation	$0.78 \times 1.35 \times 380 = 400$	$0.78 \times 1.35 \times 440 = 463$	$0.78 \times 1.35 \times 380 = 400$	$0.78 \times 1.35 \times 440 = 463$
Charging relay opening limit / Charging activation	$0.73 \times 1.35 \times 380 = 374$	$0.73 \times 1.35 \times 440 = 433$	$0.73 \times 1.35 \times 380 = 374$	$0.73 \times 1.35 \times 440 = 433$
DC voltage at upper bound of supply voltage range ( $U_{DCmax}$ )	560	648	(variable)	(variable)
DC voltage at lower bound of supply voltage range ( $U_{DCmin}$ )	513	594	(variable)	(variable)
Standby limit	$0.73 \times 1.35 \times 380 = 374$	$0.73 \times 1.35 \times 440 = 433$	$0.73 \times 1.35 \times 380 = 374$	$0.73 \times 1.35 \times 440 = 433$
Undervoltage fault limit <sup>1)</sup>	$0.73 \times 1.35 \times 380 = 374$	$0.73 \times 1.35 \times 440 = 433$	$0.73 \times 1.35 \times 380 = 374$	$0.73 \times 1.35 \times 440 = 433$

<sup>1)</sup> See section [Triggering the undervoltage fault](#) on page [174](#).

**Triggering the undervoltage warning**

The undervoltage warning [A3A2](#) is triggered if one of the following conditions is active:

- If the DC link voltage goes below the undervoltage warning limit (85%) when the drive is not modulating.
- If the DC link voltage goes below the standby limit (73%) when the drive is modulating, and auto restart is enabled (that is [21.18 Auto restart time](#) > 0.0 s). The warning will continue to appear if the actual DC link voltage is continuously

below the standby limit and until the auto restart time is elapsed. The drive control board must be externally powered by 24 VDC for this functionality; otherwise the control board can be switched off if the voltage goes below the hardware limit.

### Triggering the undervoltage fault

The undervoltage fault [3220](#) is triggered if the drive is modulating and one of the following conditions is active:

- If the DC link voltage goes below the undervoltage trip limit (73%) and auto restart is not enabled (that is [21.18 Auto restart time](#) = 0.0 s).
- If the DC link voltage goes below the undervoltage trip limit (73%) and auto restart is enabled (that is [21.18 Auto restart time](#) > 0.0 s), the undervoltage trip will occur if DC link voltage is continuously below the undervoltage trip limit and after the auto restart time is elapsed. The drive control board must be externally powered by 24 VDC for this functionality; otherwise the control board can be switched off just showing the undervoltage warning.

### Settings and diagnostics

Parameters [01.11 DC voltage](#) (page 199), [30.30 Overvoltage control...30.31 Undervoltage control](#) (page 307) and [95.01 Supply voltage...95.02 Adaptive voltage limits](#) (page 412).

Events: [A3A2 DC link undervoltage](#) (page 483) and [3220 DC link undervoltage](#) (page 495).

---

## ■ Brake chopper

A brake chopper can be used to handle the energy generated by a decelerating motor. When the DC voltage rises high enough, the chopper connects the DC circuit to an external brake resistor. The chopper operation is based on hysteresis.

The internal brake choppers in the drive (in frames R1...R3) start conducting at internal brake chopper start limit 780 V and stop conducting at internal brake chopper stop limit 760 V (AC supply 380...480 V).

For information on external brake choppers, refer to their documentation.

**Note:** Overvoltage control needs to be disabled for the chopper to operate.

### Settings and diagnostics

Parameter group: [43 Brake chopper](#) (page 371).

Parameter: [01.11 DC voltage](#) (page 199).

Events: [A792 Brake resistor wiring](#) (page 487), [A793 BR excess temperature](#) (page 488), [A79C BC IGBT excess temperature](#) (page 488), [7183 BR excess temperature](#) (page 500) and [7192 BC IGBT excess temperature](#) (page 500).

---

## Safety and protections

### ■ Fixed/Standard protections

#### Overcurrent

If the output current exceeds the internal overcurrent limit, the IGBTs are shut down immediately to protect the drive.

#### DC overvoltage

See section [Overvoltage control](#) on page 169.

#### DC undervoltage

See section [Undervoltage control \(power loss ride-through\)](#) on page 169.

#### Drive temperature

If the temperature rises high enough, the drive first starts to limit the switching frequency and then the current to protect itself. If it is still keeps heating up, for example because of a fan failure, an overtemperature fault is generated.

#### Short circuit

In case of a short circuit, the IGBTs are shut down immediately to protect the drive.

### ■ Emergency stop

The emergency stop signal is connected to the input selected by parameter [21.05 Emergency stop source](#). An emergency stop can also be generated through fieldbus (parameter [06.01 Main control word](#), bits 0...2).

The mode of the emergency stop is selected by parameter [21.04 Emergency stop mode](#). The following modes are available:

- Off1: Stop along the standard deceleration ramp defined for the particular reference type in use
- Off2: Stop by coasting
- Off3: Stop by the emergency stop ramp defined by parameter [23.23 Emergency stop time](#).

With Off1 or Off3 emergency stop modes, the ramp-down of the motor speed can be supervised by parameters [31.32 Emergency ramp supervision](#) and [31.33 Emergency ramp supervision delay](#).

---



**Notes:**

- The installer of the equipment is responsible for installing the emergency stop devices and all additional devices needed for the emergency stop function to fulfill the required emergency stop categories. For more information, contact your local ABB representative.
- After an emergency stop signal is detected, the emergency stop function cannot be canceled even though the signal is canceled.
- If the minimum (or maximum) torque limit is set to 0%, the emergency stop function may not be able to stop the drive.

Settings and diagnostics**Menu - Primary settings - Start, stop, reference - Run permissions**

Parameters: [21.04 Emergency stop mode](#)...[21.05 Emergency stop source](#) (page 258), [23.23 Emergency stop time](#) (page 278) and [31.32 Emergency ramp supervision](#)...[31.33 Emergency ramp supervision delay](#) (page 317).

Events: [AFE1 Emergency stop \(off2\)](#)...[AFE2 Emergency stop \(off1 or off3\)](#) (page 491) and [73B0 Emergency ramp failed](#) (page 500).

**■ Motor thermal protection**

The control program features two separate motor temperature monitoring functions. The temperature data sources and warning/trip limits can be set up independently for each function.

The motor temperature can be monitored using

- the motor thermal protection model (estimated temperature derived internally inside the drive), or
- sensors installed in the windings. This will result in a more accurate motor model.

The motor thermal protection model fulfills standard IEC/EN 61800-5-1 ed. 2.1 requirements for thermal memory retention and speed sensitivity. The estimated temperature is retained over power down. Speed dependency is set by parameters.

**Motor thermal protection model**

The drive calculates the temperature of the motor on the basis of the following assumptions:

1. When power is applied to the drive for the first time, the motor is assumed to be at ambient temperature (defined by parameter [35.50 Motor ambient temperature](#)). After this, when power is applied to the drive, the motor is assumed to be at the estimated temperature.
  2. Motor temperature is calculated using the user-adjustable motor thermal time and motor load curve. The load curve should be adjusted in case the ambient temperature exceeds 30 °C.
-

**Note:** The motor thermal model can be used when only one motor is connected to the inverter.

## Insulation

---

**⚠ WARNING!** IEC 60664 requires double or reinforced insulation between live parts and the surface of accessible parts of electrical equipment which are either non-conductive or conductive but not connected to the protective earth.

---

To fulfil this requirement, connect a thermistor to the drive's control terminals using any of these alternatives:

- Separate the thermistor from live parts of the motor with double reinforced insulation.
- Protect all circuits connected to the drive's digital and analog inputs. Protect against contact, and insulate from other low voltage circuits with basic insulation (rated for the same voltage level as the drive's main circuit).
- Use an external thermistor relay. The relay insulation must be rated for the same voltage level as the drive's main circuit.

When CMOD-02 multifunction module is used, it provides sufficient insulation.

## Temperature monitoring using PTC sensors

PTC sensors are connected through a CMOD-02 multifunction module (see chapter *Optional I/O extension modules*, section *CMOD-02 multifunction extension module (external 24 V AC/DC and isolated PTC interface)* in the *Hardware manual* of the drive).

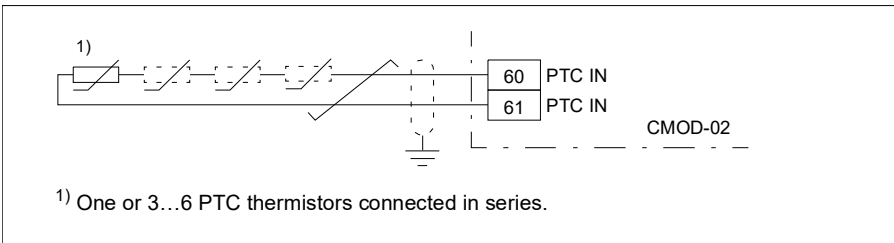

The resistance of the PTC sensor increases when its temperature rises. The increasing resistance of the sensor decreases the voltage at the input, and eventually its state switches from 1 to 0, indicating overtemperature.

1...3 PTC sensors can also be connected in series to an analog input and an analog output. The analog output feeds a constant excitation current of 1.6 mA through the sensor. The sensor resistance increases as the motor temperature rises, as does the voltage over the sensor. The temperature measurement function calculates the resistance of the sensor and generates an indication if overtemperature is detected.

---

Leave the sensor end of the cable shield unconnected.

For wiring of the sensor, see chapter Electrical installation in the *Hardware manual* of the drive.

The figure below shows typical PTC sensor resistance value as a function of temperature.

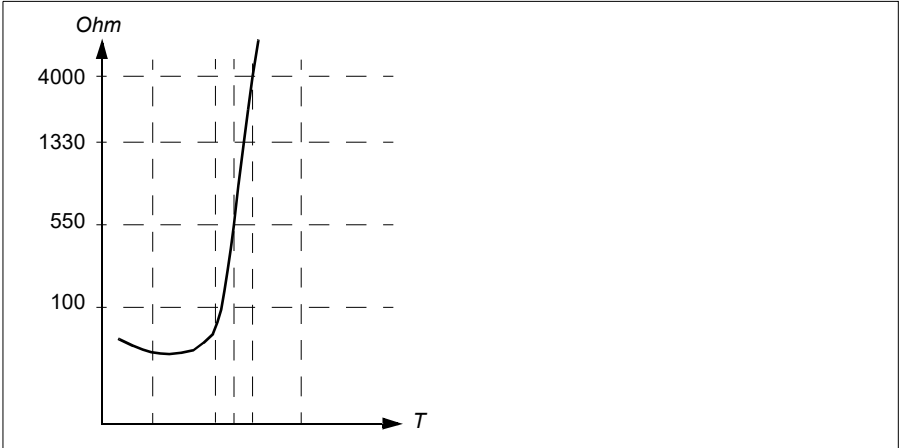

Isolated PTC sensor can also be connected directly to digital input DI6. At the motor end, the cable shield should be earthed through a capacitor. If this is not possible, leave the shield unconnected. See section [Insulation](#) on page 178.

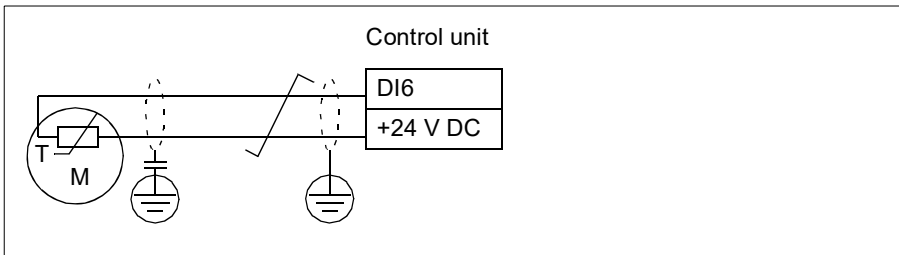

For wiring of the sensor, see the *Hardware manual* of the drive.

### Temperature monitoring using Pt100 sensors

1...3 Pt100 sensors can be connected in series to an analog input and an analog output.

The analog output feeds a constant excitation current of 9.1 mA through the sensor. The sensor resistance increases as the motor temperature rises, as does the voltage over the sensor. The temperature measurement function reads the voltage through the analog input and converts it into degrees Celsius.

It is possible to adjust the motor temperature supervision limits and select how the drive reacts when overtemperature is detected.

See section [Insulation](#) on page 178.

For the wiring of the sensor, see chapter *Electrical installation*, section *A11 and A12 as Pt100, Pt1000, Ni1000, KTY83 and KTY84 sensor inputs (X1)* in the *Hardware manual* of the drive.

### Temperature monitoring using Pt1000 sensors

1...3 Pt1000 sensors can be connected in series to an analog input and an analog output.

The analog output feeds a constant excitation current of 0.1 mA through the sensor. The sensor resistance increases as the motor temperature rises, as does the voltage over the sensor. The temperature measurement function reads the voltage through the analog input and converts it into degrees Celsius.

See section [Insulation](#) on page 178.

For the wiring of the sensor, see chapter *Electrical installation*, *A11 and A12 as Pt100, Pt1000, Ni1000, KTY83 and KTY84 sensor inputs (X1)* in the *Hardware manual* of the drive.

### Temperature monitoring using Ni1000 sensors

One Ni1000 sensor can be connected to an analog input and an analog output on the control unit.

The analog output feeds a constant excitation current of 9.1 mA through the sensor. The sensor resistance increases as the motor temperature rises, as does the voltage over the sensor. The temperature measurement function reads the voltage through the analog input and converts it into degrees Celsius.

See section [Insulation](#) on page 178.

For the wiring of the sensor, see chapter *Electrical installation*, *A11 and A12 as Pt100, Pt1000, Ni1000, KTY83 and KTY84 sensor inputs (X1)* in the *Hardware manual* of the drive.

### Temperature monitoring using KTY84 sensors

One KTY84 sensor can be connected to an analog input and an analog output on the control unit.

The analog output feeds a constant excitation current of 2.0 mA through the sensor. The sensor resistance increases as the motor temperature rises, as does the voltage over the sensor. The temperature measurement function reads the voltage through the analog input and converts it into degrees Celsius.

The figure and table on page 181 show typical KTY84 sensor resistance values as a function of the motor operating temperature.

---

See section [Insulation](#) on page 178.

For the wiring of the sensor, see chapter *Electrical installation, AI1 and AI2 as Pt100, Pt1000, Ni1000, KTY83 and KTY84 sensor inputs (X1)* in the *Hardware manual* of the drive.

### Temperature monitoring using KTY83 sensors

One KTY83 sensor can be connected to an analog input and an analog output on the control unit.

The analog output feeds a constant excitation current of 1.0 mA through the sensor. The sensor resistance increases as the motor temperature rises, as does the voltage over the sensor. The temperature measurement function reads the voltage through the analog input and converts it into degrees Celsius.

The figure and table below show typical KTY83 sensor resistance values as a function of the motor operating temperature.

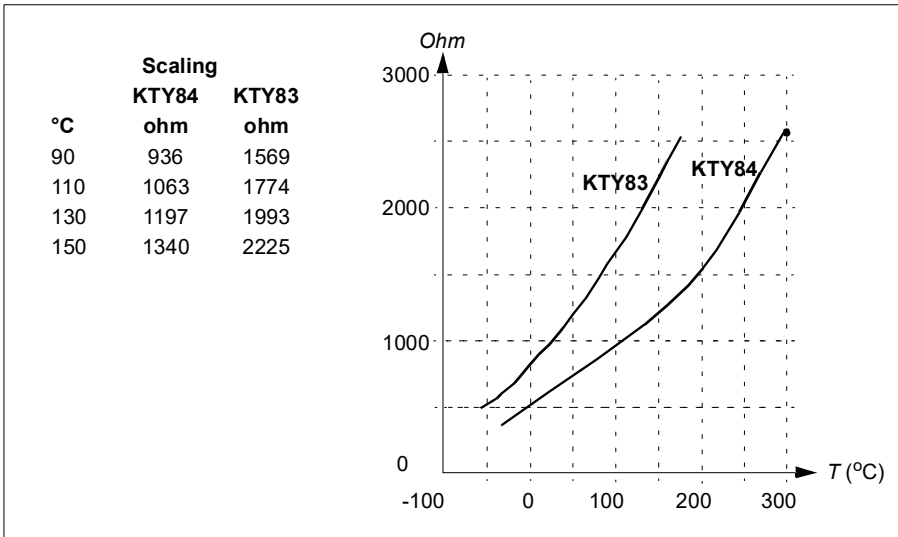

It is possible to adjust the motor temperature supervision limits and select how the drive reacts when overtemperature is detected.

See section [Insulation](#) on page 178.

For the wiring of the sensor, see chapter *Electrical installation, AI1 and AI2 as Pt100, Pt1000, Ni1000, KTY83 and KTY84 sensor inputs (X1)* in the *Hardware manual* of the drive.

## Temperature monitoring using thermistor relays

A normally closed or a normally open thermistor relay can be connected to digital input DI6.

See section [Insulation](#) on page 178.

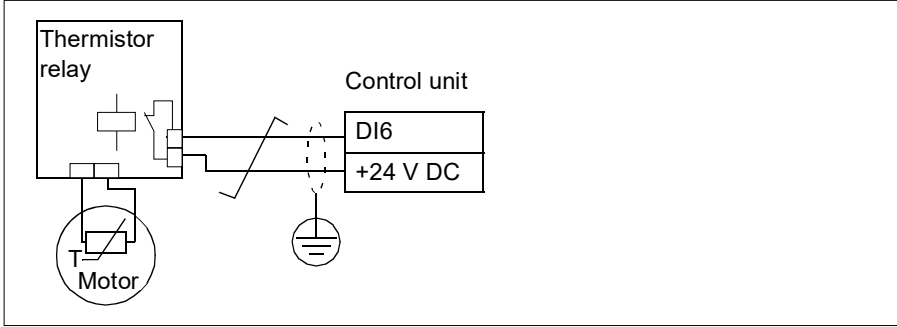

### Settings and diagnostics

**Menu - Primary settings - Motor - Thermal protection estimated,  
Menu - Primary settings - Motor - Thermal protection measured**

Parameter group: [35 Motor thermal protection](#) (page 335).

Events: [A491 External temperature 1](#) (page 483), [A492 External temperature 2](#) (page 483), [4981 External temperature 1](#) (page 495) and [4982 External temperature 2](#) (page 495).

### ■ Motor overload protection

This section describes motor overload protection without using motor thermal protection model, either with estimated or measured temperature. For protection with the motor thermal protection model, see section [Motor thermal protection](#) on page 177.

Motor overload protection is required and specified by multiple standards including the US National Electric Code (NEC), UL 508C and the common UL\IEC 61800-5-1 standard in conjunction with IEC 60947-4-1. The standards allow for motor overload protection without external temperature sensors.

The Motor overload protection fulfills standard IEC/EN 61800-5-1 ed. 2.1 requirements for thermal memory retention and speed sensitivity. The estimated temperature is retained over power down. Speed dependency is set by parameters.

The protection feature allows the user to specify the class of operation in the same manner as the overload relays are specified in standards IEC 60947-4-1 and NEMA ICS 2.

Motor overload protection requires that you specify a motor current tripping level. This is defined by a curve using parameters [35.51](#), [35.52](#) and [35.53](#). The tripping level is the motor current at which the overload protection will ultimately trip if the motor current remains at this level continuously.

The motor overload class (class of operation), parameter [35.57 Motor overload class](#), is given as the time required for the overload relay to trip when operating at 7.2 times the tripping level in the case of IEC 60947-4-1 and 6 times the tripping level in the case of NEMA ICS 2. The standards also specify the time to trip for current levels between the tripping level and the 6 times tripping level. The drive satisfies the IEC standard and NEMA standard trip times.

Using class 20 satisfies the UL 508C requirements.

The motor overload algorithm monitors the squared ratio (motor current / tripping level)<sup>2</sup> and accumulates this over time. This is sometimes referred to as I<sup>2</sup>t protection. The accumulated value is shown with parameter [35.05](#).

You can define with parameter [35.56](#) that when [35.05](#) reaches 88%, a motor overload warning will be generated, and when it reaches 100%, the drive will trip on the motor overload fault. The rate at which this internal value is increased depends on the actual current, tripping level current and overload class selected.

Parameters [35.51](#), [35.52](#) and [35.53](#) serve a dual purpose. They determine the load curve for temperature estimate as well as specify the overload tripping level.

### Settings and diagnostics

Parameters common to motor thermal protection and motor overload protection: [35.51 Motor load curve](#)...[35.53 Break point](#) (page [344](#)).

Parameters specific to motor overload protection: [35.05 Motor overload level](#) (page [336](#)), [35.56 Motor overload action](#)...[35.57 Motor overload class](#) (page [346](#)).

Events: [A783 Motor overload](#) (page [487](#)) and [7122 Motor overload](#) (page [500](#)).

## ■ Programmable protection functions

### External events (parameters [31.01](#)...[31.10](#))

Five different event signals from the process can be connected to selectable inputs to generate trips and warnings for the driven equipment. When the signal is lost, an external event (fault, warning, or a mere log entry) is generated. The contents of the messages can be edited on the control panel by selecting **Menu - Primary settings - Advanced functions - External events**.

### Motor phase loss detection (parameter [31.19](#))

The parameter selects how the drive reacts whenever a motor phase loss is detected.

### **Supply phase loss detection (parameter 31.21)**

The parameter selects how the drive reacts whenever a supply phase loss is detected.

### **Safe torque off detection (parameter 31.22)**

The drive monitors the status of the Safe torque off input, and this parameter selects which indications are given when the signals are lost. (The parameter does not affect the operation of the Safe torque off function itself). For more information on the Safe torque off function, see chapter *Safe torque off function* in the *Hardware manual* of the drive.

### **Swapped supply and motor cabling (parameter 31.23)**

The drive can detect if the supply and motor cables have accidentally been swapped (for example, if the supply is connected to the motor connection of the drive). The parameter selects if a fault is generated or not.

### **Stall protection (parameters 31.24...31.28)**

The drive protects the motor in a stall situation. It is possible to adjust the supervision limits (current, frequency and time) and choose how the drive reacts to a motor stall condition.

### **Overspeed protection (parameters 31.30 and 31.31)**

The user can set overspeed and overfrequency limits by specifying a margin that is added to the currently-used maximum and minimum speed or frequency limits.

### **Local control loss detection (parameter 49.05)**

The parameter selects how the drive reacts to a control panel or PC tool communication break.

### **AI supervision (parameters 12.03...12.04)**

The parameters select how the drive reacts when an analog input signal moves out of the minimum and/or maximum limits specified for the input. This can be due to broken I/O wiring or sensor.

### **Main fan fault (parameter 31.35)**

The parameter selects how the drive reacts when a main cooling fan speed problem is detected. For frame sizes R6 or larger only.

### **Auxiliary fan fault (parameter 31.36)**

The parameter selects how the drive reacts when an auxiliary fan problem is detected.

---



## Settings and diagnostics

Parameters: [12.03 AI supervision function...](#) [12.04 AI supervision selection](#) (page 226), [31.01 External event 1 source...](#) [31.35 Main fan fault function](#) (page 318) [31.36 Aux fan fault function](#) (page 318) and [49.05 Communication loss action](#) (page 384).

### Events:

- [A981 External warning 1](#) (page 490)...[A985 External warning 5](#) (page 491), [9081 External fault 1](#) (page 502)...[9085 External fault 5](#) (page 502)
- [3381 Output phase loss](#) (page 495)
- [3130 Input phase loss](#) (page 494)
- [B5A0 STO event](#) (page 492), [A5A0 Safe torque off](#) (page 485), [5091 Safe torque off](#) (page 496), [FA81 Safe torque off 1](#) (page 502), [FA82 Safe torque off 2](#), (page 502)
- [3181 Wiring or earth fault](#) (page 494)
- [A780 Motor stall](#) (page 487), [7121 Motor stall](#) (page 499)
- [7310 Overspeed](#) (page 500), [73F0 Overfrequency](#) (page 500)
- [A7EE Panel loss](#) (page 489), [7081 Control panel loss](#) (page 499)
- [A8A0 AI supervision](#) (page 489), [80A0 AI supervision](#) (page 501)
- [73B0 Emergency ramp failed](#) (page 500)
- [A581 Fan](#) (page 484), [5080 Fan](#) (page 496)
- [A582 Auxiliary fan missing](#) (page A582), [5081 Auxiliary fan broken](#) (page 496).

## ■ Automatic fault resets

The drive can automatically reset itself after overcurrent, overvoltage, undervoltage and external faults. The user can also specify a fault that is automatically reset.

By default, automatic resets are off and must be specifically activated by the user.



**WARNING!** Before you activate the function, make sure that no dangerous situations can occur. The function resets the drive automatically and continues operation after a fault.

---

## Settings and diagnostics

### **Menu - Primary settings - Advanced functions - Autoreset faults**

Parameters: [31.12 Autoreset selection...](#) [31.16 Delay time](#) (page 311).

Events: -

---

## Diagnostics

### ■ Signal supervision

Six signals can be selected to be supervised by this function. Whenever a supervised signal exceeds or falls below predefined limits, a bit in [32.01 Supervision status](#) is activated, and a warning or fault generated.

The supervised signal is low-pass filtered.

#### Settings and diagnostics

Parameter group: [32 Supervision](#) (page [319](#)).

Parameter: [32.01 Supervision status](#) (page [319](#)).

Events: [A8B0 ABB Signal supervision 1](#) (page [490](#))...[A8B5 ABB Signal supervision 6](#) (page [490](#)), [80B0 Signal supervision 1](#) (page [501](#))...[80B5 Signal supervision 6](#) (page [502](#)).

### ■ Energy saving calculators

This feature consists of the following functionalities:

- An energy optimizer that adjusts the motor flux in such a way that the total system efficiency is maximized
- A counter that monitors used and saved energy by the motor and displays them in kWh, currency or volume of CO<sub>2</sub> emissions, and
- A load analyzer showing the load profile of the drive (see separate section on page [187](#)).

In addition, there are counters that show energy consumption in kWh of the current and previous hour as well as the current and previous day.

The amount of energy that has passed through the drive (in either direction) is counted and shown full as GWh, MWh and kWh. The cumulative energy is also shown as full kWh. All these counters are resettable.

**Note:** The accuracy of the energy savings calculation is directly dependent on the accuracy of the reference motor power given in parameter [45.19 Comparison power](#).

#### Settings and diagnostics

### Menu - Energy efficiency

Parameter group: [45 Energy efficiency](#) (page [375](#)).

Parameters: [01.50 Current hour kWh](#)...[01.53 Previous day kWh](#) (page [200](#)), [01.55 Inverter GWh counter \(resettable\)](#)...[01.58 Cumulative inverter energy \(resettable\)](#) (page [201](#)).

Events: -

---

## ■ Load analyzer

### Peak value logger

The user can select a signal to be monitored by a peak value logger. The logger records the peak value of the signal along with the time the peak occurred, as well as motor current, DC voltage and motor speed at the time of the peak. The peak value is sampled at 2 ms intervals.

### Amplitude loggers

The control program has two amplitude loggers.

For amplitude logger 2, the user can select a signal to be sampled at 200 ms intervals, and specify a value that corresponds to 100%. The collected samples are sorted into 10 read-only parameters according to their amplitude. Each parameter represents an amplitude range 10 age points wide, and displays the age of the collected samples that have fallen within that range.

You can view this graphically with the assistant control panel or the Drive composer PC tool.

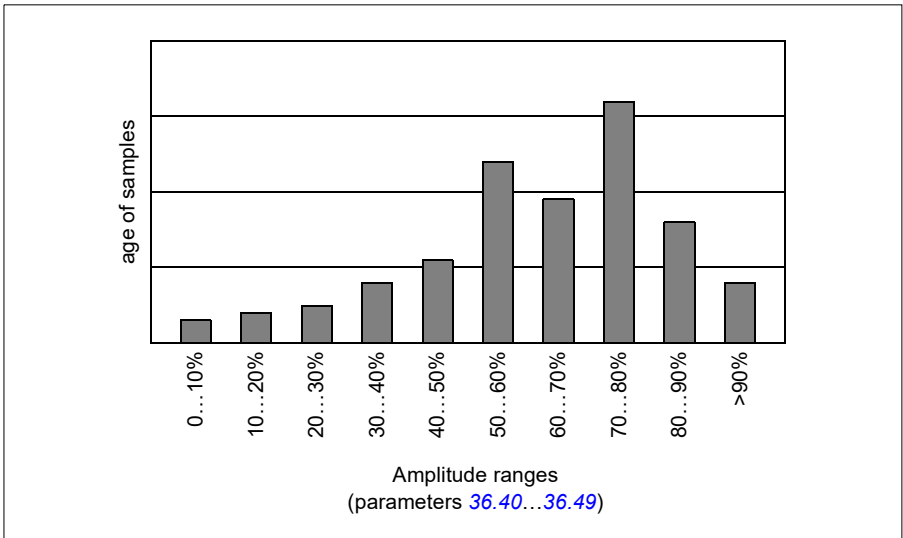

Amplitude logger 1 is fixed to monitor motor current, and cannot be reset. With amplitude logger 1, 100% corresponds to the maximum output current of the drive ( $I_{\max}$ ), which is listed in the *Hardware manual* of the drive. The measured current is logged continuously. The distribution of samples is shown by parameters [36.20...36.29](#).

Settings and diagnostics**Menu - Diagnostics - Load profile**

Parameter group: [36 Load analyzer](#) (page [346](#)).

Events: -

### ■ Diagnostics menu

The **Diagnostics** menu provides quick information about active faults, warnings and inhibits in the drive and how to fix and reset them. It also helps you to find out why the drive is not starting, stopping or running at the desired speed.

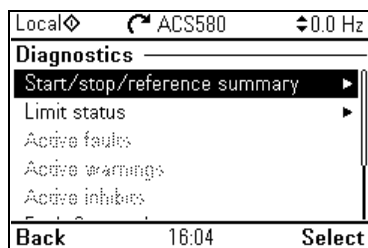

- **Start/stop/reference summary:** Use this view to find out where the control comes from if the drive is not starting or stopping as expected, or runs at an undesired speed.
- **Limit status:** Use this view to find out whether any limitations are active if the drive is running at undesired speed.
- **Active faults:** Use this view to see currently active faults and how to fix and reset them.
- **Active warnings:** Use this view to see currently active warnings and how to fix them.
- **Active inhibits:** Use this view to see the active inhibits and how to fix them. In addition, in the **Clock, region, display** menu you can disable (enabled by default) and pop-up views showing information on inhibits when you try to start the drive but it is prevented.
- **Fault and event log:** Shows lists faults and other events.
- **Fieldbus:** Use this view to find out status information and sent and received data from fieldbus.
- **Load profile:** Use this view to see the status information of load distribution (that is, drive running time spent on each load level) and peak load levels.

Settings and diagnostics**Menu - Diagnostics****Menu - Primary settings - Clock, region, display - Show inhibit pop-up.**

## Miscellaneous

### ■ Backup and restore

You can make backups of the settings manually to the assistant control panel. The assistant control panel also keeps one automatic backup. You can restore a backup to another drive, or a new drive replacing a faulty one. You can make backups and restore on the control panel or with the Drive composer PC tool.

#### Backup

##### Manual backup

Make a backup when necessary, for example, after you have started up the drive or when you want to copy the settings to another drive.

Parameter changes from fieldbus interfaces are ignored unless you have forced parameter saving with parameter [96.07 Parameter save manually](#).



##### Automatic backup

The assistant control panel has a dedicated space for one automatic backup. An automatic backup is created two hours after the last parameter change. After completing the backup, the control panel waits for 24 hours before checking if there are additional parameter changes. If there are, it creates a new backup overwriting the previous one when two hours have passed after the latest change.

You cannot adjust the delay time or disable the automatic backup function.

Parameter changes from fieldbus interfaces are ignored unless you have forced parameter saving with parameter [96.07 Parameter save manually](#).

#### Restore

The backups are shown on the control panel. Automatic backups are marked with icon  and manual backups with . To restore a backup, select it and press . In the following display you can view backup contents and restore all or select a subset to be restored.

**Note:** To restore a backup, the drive has to be in Local control.

---

**Note:** There is a risk of removing the **QR code** menu entry permanently if a backup from a drive with an old firmware or old control panel firmware is restored to a drive with a new firmware from October 2014 or later.

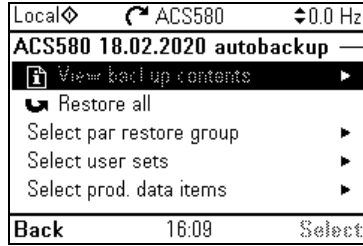
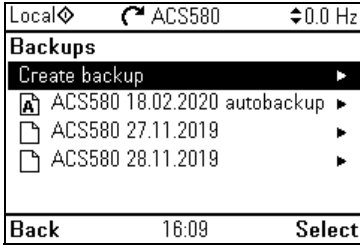

## Settings and diagnostics

### Menu - Backups

Parameter: [96.07 Parameter save manually](#) (page 418).

Events: -

### ■ User parameter sets

The drive supports four user parameter sets that can be saved to the permanent memory and recalled using drive parameters. It is also possible to use digital inputs to switch between user parameter sets. To change a user parameter set, the drive has to be stopped.

A user parameter set contains all editable values in parameter groups 10...99 except

- forced I/O values such as parameters [10.03 DI force selection](#) and [10.04 DI forced data](#)
- I/O extension module settings (group 15)
- data storage parameters (group 47)
- fieldbus communication settings (groups 50...53 and 58)
- parameter [95.01 Supply voltage](#).

As the motor settings are included in the user parameter sets, make sure the settings correspond to the motor used in the application before recalling a user set. In an application where different motors are used with the drive, the motor ID run needs to be performed with each motor and the results saved to different user sets. The appropriate set can then be recalled when the motor is switched.

Settings and diagnostics**Menu - Primary settings - Advanced functions - User sets**

Parameters: [10.03 DI force selection...](#)[10.04 DI forced data](#) (page 217), [95.01 Supply voltage](#) (page 412) and [96.10 User set status...](#)[96.13 User set I/O mode in2](#) (page 419).

Event: [64B2 User set fault](#) (page 498).

### ■ Data storage parameters

Twelve (eight 32-bit, four 16-bit) parameters are reserved for data storage. These parameters are unconnected by default and can be used for linking, testing and commissioning purposes. They can be written to and read from using other parameters' source or target selections.

Settings and diagnostics

Parameter group: [47 Data storage](#) (page 383).

Events: -

### ■ Parameter checksum calculation

Two parameter checksums, A and B, can be calculated from a set of parameters to monitor changes in the drive configuration. The sets are different for checksums A and B. Each of these checksum is compared to the corresponding reference checksum; in case of a mismatch, an event (a pure event, warning or fault) is generated. The calculated checksum can be set as the new reference checksum.

The set of parameters for checksum A does not include fieldbus settings.

The parameters included in the checksum A calculation are user editable parameters in parameter groups 10, 11, 12, 13, 15, 19, 20, 21, 22, 23, 24, 25, 28, 30, 31, 32, 34, 35, 36, 37, 40, 41, 43, 45, 46, 70, 71, 72, 73, 74, 76, 80, 94, 95, 96, 97, 98, 99.

The set of parameters for checksum B does not include

- fieldbus settings
- motor data settings
- energy data settings.

The parameters included in the checksum B calculation are user editable parameters in parameter groups 10, 11, 12, 13, 15, 19, 20, 21, 22, 23, 24, 25, 28, 30, 31, 32, 34, 35, 36, 37, 40, 41, 43, 46, 70, 71, 72, 73, 74, 76, 80, 94, 95, 96, 97.

Settings and diagnostics

Parameters: [96.54 Checksum action...](#)[96.69 Actual checksumB](#) (page 422) and [96.71 Approved checksum A...](#)[96.72 Approved checksum B](#) (page 423).

Events: [B686 Checksum mismatch](#) (page 482), [A686 Checksum mismatch](#) (page 486) and [6200 Checksum mismatch](#) (page 497).

## ■ User lock

For better cybersecurity, ABB highly recommends that you set a master pass code to prevent, for example, the changing of parameter values and/or the loading of firmware and other files.



**WARNING!** ABB will not be liable for damages or losses caused by the failure to activate the user lock using a new pass code. See [Cybersecurity disclaimer](#) (page 20).

---

- To activate the user lock for the first time:
- Enter the default pass code, 10000000, into [96.02 Pass code](#). This will make parameters [96.100...96.102](#) visible.
- Enter a new pass code into [96.100 Change user pass code](#). Always use eight digits; if using Drive composer, finish with Enter.
- Confirm the new pass code in [96.101 Confirm user pass code](#).



**WARNING!** Store the pass code in a safe place – the user lock cannot be opened even by ABB if the pass code is lost.

---

- In [96.102 User lock functionality](#), define the actions that you want to prevent (ABB recommends you select all the actions unless otherwise required by the application).
- Enter an invalid pass code into [96.02 Pass code](#).
- Activate [96.08 Control board boot](#), or cycle the power to the drive.
- Check that parameters [96.100...96.102](#) are hidden. If they are not, enter another random pass code into [96.02](#).

To reopen the lock, enter your pass code into [96.02 Pass code](#). This will again make parameters [96.100...96.102](#) visible.

### Settings and diagnostics

Parameters: [96.02 Pass code](#) (page 417) and [96.100 Change user pass code...96.102 User lock functionality](#) (page 424).

Events: [A6B0 User lock is open](#) (page 486) and [A6B1 User pass code not confirmed](#) (page 486).

## ■ Sine filter support

The control program has a setting that enables the use of ABB sine filters (available separately). With a sine filter connected to the output of the drive, bit 1 of [95.15](#)

---



[Special HW settings](#) must be switched on. The setting forces the drive to use the scalar motor control mode, and limits the switching and output frequencies to

- prevent the drive from operating at filter resonance frequencies, and
- protect the filter from overheating.

Contact your local ABB representative before connecting a sine filter from another manufacturer.

#### Settings and diagnostics

Parameter: [95.15 Special HW settings](#) (page [412](#)).

Events: -

---





# Parameters

---

## What this chapter contains

The chapter describes the parameters, including actual signals, of the control program. At the end of the chapter, on page [437](#), there is a separate list of the parameters whose default values are different between 50 Hz and 60 Hz supply frequency settings.

---

## Terms and abbreviations

Term	Definition
Actual signal	Type of <a href="#">parameter</a> that is the result of a measurement or calculation by the drive, or contains status information. Most actual signals are read-only, but some (especially counter-type actual signals) can be reset.
Def	(In the following table, shown on the same row as the parameter name) The default value of a <a href="#">parameter</a> when used in the Factory macro. For information on other macro-specific parameter values, see chapter <a href="#">Control macros</a> (page 77).
FbEq16	(In the following table, shown on the same row as the parameter range, or for each selection) 16-bit fieldbus equivalent: The scaling between the value shown on the control panel and the integer used in communication when a 16-bit value is selected for transmission to an external system. A dash (-) indicates that the parameter is not accessible in 16-bit format. The corresponding 32-bit scalings are listed in chapter <a href="#">Additional parameter data</a> (page 443).
Other	The value is taken from another parameter. Choosing "Other" displays a parameter list in which the user can specify the source parameter.
Other [bit]	The value is taken from a specific bit in another parameter. Choosing "Other" displays a parameter list in which the user can specify the source parameter and bit.
Parameter	Either a user-adjustable operating instruction for the drive, or an <a href="#">actual signal</a> .
p.u.	Per unit
[parameter number]	Value of the parameter

## Summary of parameter groups

Group	Contents	Page
<a href="#">01 Actual values</a>	Basic signals for monitoring the drive.	199
<a href="#">03 Input references</a>	Values of references received from various sources.	202
<a href="#">04 Warnings and faults</a>	Information on warnings and faults that occurred last.	203
<a href="#">05 Diagnostics</a>	Various run-time-type counters and measurements related to drive maintenance.	205
<a href="#">06 Control and status words</a>	Drive control and status words.	208
<a href="#">07 System info</a>	Drive hardware and firmware information.	214
<a href="#">10 Standard DI, RO</a>	Configuration of digital inputs and relay outputs.	216
<a href="#">11 Standard DIO, FI, FO</a>	Configuration of the frequency input.	225
<a href="#">12 Standard AI</a>	Configuration of standard analog inputs.	226
<a href="#">13 Standard AO</a>	Configuration of standard analog outputs.	231
<a href="#">15 I/O extension module</a>	Configuration of the I/O extension module installed in slot 2.	236
<a href="#">19 Operation mode</a>	Selection of local and external control location sources and operating modes.	245
<a href="#">20 Start/stop/direction</a>	Start/stop/direction and run/start/jog enable signal source selection; positive/negative reference enable signal source selection.	247
<a href="#">21 Start/stop mode</a>	Start and stop modes; emergency stop mode and signal source selection; DC magnetization settings.	257
<a href="#">22 Speed reference selection</a>	Speed reference selection; motor potentiometer settings.	266
<a href="#">23 Speed reference ramp</a>	Speed reference ramp settings (programming of the acceleration and deceleration rates for the drive).	276
<a href="#">24 Speed reference conditioning</a>	Speed error calculation; speed error window control configuration; speed error step.	280
<a href="#">25 Speed control</a>	Speed controller settings.	280
<a href="#">26 Torque reference chain</a>	Settings for the torque reference chain.	286
<a href="#">28 Frequency reference chain</a>	Settings for the frequency reference chain.	290
<a href="#">30 Limits</a>	Drive operation limits.	301
<a href="#">31 Fault functions</a>	Configuration of external events; selection of behavior of the drive upon fault situations.	309
<a href="#">32 Supervision</a>	Configuration of signal supervision functions 1...6.	319
<a href="#">34 Timed functions</a>	Configuration of the timed functions.	327
<a href="#">35 Motor thermal protection</a>	Motor thermal protection settings such as temperature measurement configuration, load curve definition and motor fan control configuration.	335
<a href="#">36 Load analyzer</a>	Peak value and amplitude logger settings.	346
<a href="#">37 User load curve</a>	Settings for user load curve.	349
<a href="#">40 Process PID set 1</a>	Parameter values for process PID control.	353
<a href="#">41 Process PID set 2</a>	A second set of parameter values for process PID control.	369
<a href="#">43 Brake chopper</a>	Settings for the internal brake chopper.	371
<a href="#">44 Mechanical brake control</a>	Configuration of mechanical brake control.	373
<a href="#">45 Energy efficiency</a>	Settings for the energy saving calculators as well as peak and energy loggers.	375

<b>Group</b>	<b>Contents</b>	<b>Page</b>
<a href="#">46 Monitoring/scaling settings</a>	Speed supervision settings; actual signal filtering; general scaling settings.	<a href="#">379</a>
<a href="#">47 Data storage</a>	Data storage parameters that can be written to and read from using other parameters' source and target settings.	<a href="#">383</a>
<a href="#">49 Panel port communication</a>	Communication settings for the control panel port on the drive.	<a href="#">384</a>
<a href="#">50 Fieldbus adapter (FBA)</a>	Fieldbus communication configuration.	<a href="#">386</a>
<a href="#">51 FBA A settings</a>	Fieldbus adapter A configuration.	<a href="#">390</a>
<a href="#">52 FBA A data in</a>	Selection of data to be transferred from drive to fieldbus controller through fieldbus adapter A.	<a href="#">392</a>
<a href="#">53 FBA A data out</a>	Selection of data to be transferred from fieldbus controller to drive through fieldbus adapter A.	<a href="#">392</a>
<a href="#">58 Embedded fieldbus</a>	Configuration of the embedded fieldbus (EFB) interface.	<a href="#">393</a>
<a href="#">71 External PID1</a>	Configuration of external PID.	<a href="#">400</a>
<a href="#">76 PFC configuration</a>	PFC (Pump and fan control) and Autochange configuration parameters. See also section Pump and fan control (PFC) on page 142.	<a href="#">403</a>
<a href="#">77 PFC maintenance and monitoring</a>	PFC (Pump and fan control) and Autochange configuration parameters. See also section Pump and fan control (PFC) on page 142.	<a href="#">411</a>
<a href="#">95 HW configuration</a>	Various hardware-related settings.	<a href="#">412</a>
<a href="#">96 System</a>	Language selection; access levels; macro selection; parameter save and restore; control unit reboot; user parameter sets; unit selection; parameter checksum; user lock.	<a href="#">415</a>
<a href="#">97 Motor control</a>	Switching frequency; slip gain; voltage reserve; flux braking; anti-cogging (signal injection); IR compensation.	<a href="#">425</a>
<a href="#">98 User motor parameters</a>	Motor values supplied by the user that are used in the motor model.	<a href="#">429</a>
<a href="#">99 Motor data</a>	Motor configuration settings.	<a href="#">431</a>

---

## Parameter listing

No.	Name/Value	Description	Def/FbEq16
<b>01 Actual values</b>		Basic signals for monitoring the drive. All parameters in this group are read-only unless otherwise noted. <b>Note:</b> Values of these actual signals are filtered with the filter time defined in group <a href="#">46 Monitoring/scaling settings</a> . The selection lists for parameters in other groups mean the raw value of the actual signal instead. For example, if a selection is "Output frequency" it does not point to the value of parameter <a href="#">01.06 Output frequency</a> but to the raw value.	
<a href="#">01.01</a>	<a href="#">Motor speed used</a>	Estimated motor speed. A filter time constant for this signal can be defined by parameter <a href="#">46.11 Filter time motor speed</a> .	-
	-30000.00... 30000.00 rpm	Estimated motor speed.	See par. <a href="#">46.01</a>
<a href="#">01.02</a>	<a href="#">Motor speed estimated</a>	Estimated motor speed in rpm. A filter time constant for this signal can be defined by parameter <a href="#">46.11 Filter time motor speed</a> .	-
	-30000.00... 30000.00 rpm	Estimated motor speed.	See par. <a href="#">46.01</a>
<a href="#">01.03</a>	<a href="#">Motor speed %</a>	Motor speed in percent of the synchronous motor speed.	-
	-1000.00... 1000.00%	Motor speed.	10 = 1%
<a href="#">01.06</a>	<a href="#">Output frequency</a>	Estimated drive output frequency in Hz. A filter time constant for this signal can be defined by parameter <a href="#">46.12 Filter time output frequency</a> .	-
	-500.00...500.00 Hz	Estimated output frequency.	See par. <a href="#">46.02</a>
<a href="#">01.07</a>	<a href="#">Motor current</a>	Measured (absolute) motor current in A.	-
	0.00...30000.00 A	Motor current.	See par. <a href="#">46.05</a> 10 = 1A
<a href="#">01.08</a>	<a href="#">Motor current % of motor nom</a>	Motor current (drive output current) in percent of the nominal motor current.	-
	0.0...1000.0%	Motor current.	1 = 1%
<a href="#">01.09</a>	<a href="#">Motor current % of drive nom</a>	Motor current (drive output current) in percent of the nominal drive current.	-
	0.0...1000.0%	Motor current.	1 = 1%
<a href="#">01.10</a>	<a href="#">Motor torque</a>	Motor torque in percent of the nominal motor torque. See also parameter <a href="#">01.30 Nominal torque scale</a> . A filter time constant for this signal can be defined by parameter <a href="#">46.13 Filter time motor torque</a> .	-
	-1600.0...1600.0%	Motor torque.	See par. <a href="#">46.03</a>
<a href="#">01.11</a>	<a href="#">DC voltage</a>	Measured DC link voltage.	-
	0.00...2000.00 V	DC link voltage.	10 = 1 V
<a href="#">01.13</a>	<a href="#">Output voltage</a>	Calculated motor voltage in V AC.	-
	0...2000 V	Motor voltage.	1 = 1 V

## 200 Parameters

No.	Name/Value	Description	Def/FbEq16
01.14	<i>Output power</i>	Drive output power. The unit is selected by parameter <a href="#">96.16 Unit selection</a> . A filter time constant for this signal can be defined by parameter <a href="#">46.14 Filter time power</a> .	-
	-32768.00... 32767.00 kW	Output power.	See par. <a href="#">46.04</a>
01.15	<i>Output power % of motor nom</i>	Output power in percent of the nominal motor power.	-
	-300.00... 300.00%	Output power.	10 = 1%
01.17	<i>Motor shaft power</i>	Estimated mechanical power at motor shaft.	-
	-32768.00... 32767.00 kW or hp	Motor shaft power.	See par. <a href="#">46.04</a>
01.18	<i>Inverter GWh counter</i>	Amount of energy that has passed through the drive (in either direction) in full gigawatt-hours. The minimum value is zero.	-
	0...65535 GWh	Energy in GWh.	1 = 1 GWh
01.19	<i>Inverter MWh counter</i>	Amount of energy that has passed through the drive (in either direction) in full megawatt-hours. Whenever the counter rolls over, <a href="#">01.18 Inverter GWh counter</a> is incremented. The minimum value is zero.	-
	0...1000 MWh	Energy in MWh.	1 = 1 MWh
01.20	<i>Inverter kWh counter</i>	Amount of energy that has passed through the drive (in either direction) in full kilowatt-hours. Whenever the counter rolls over, <a href="#">01.19 Inverter MWh counter</a> is incremented. The minimum value is zero.	-
	0...1000 kWh	Energy in kWh.	10 = 1 kWh
01.24	<i>Flux actual %</i>	Used flux reference in percent of nominal flux of motor.	-
	0...200%	Flux reference.	1 = 1%
01.30	<i>Nominal torque scale</i>	Torque that corresponds to 100% of nominal motor torque. The unit is selected by parameter <a href="#">96.16 Unit selection</a> . <b>Note:</b> This value is copied from parameter <a href="#">99.12 Motor nominal torque</a> , if entered. Otherwise the value is calculated from other motor data.	-
	0.000... 4000000.000 N·m or lb·ft	Nominal torque.	1 = 100 unit
01.50	<i>Current hour kWh</i>	Current hour energy consumption. This is the energy of the last 60 minutes (not necessarily continuous) the drive has been running, not the energy of a calendar hour. If the power is cycled, after the drive is again up and running, the parameter value is set to the value it had before the power cycle.	-
	0.00... 1000000.00 kWh	Energy.	1 = 1 kWh
01.51	<i>Previous hour kWh</i>	Previous hour energy consumption. The value <a href="#">01.50 Current hour kWh</a> is stored here when its values has been cumulated for 60 minutes. If the power is cycled, after the drive is again up and running, the parameter value is set to the value it had before the power cycle.	-
	0.00... 1000000.00 kWh	Energy.	1 = 1 kWh



No.	Name/Value	Description	Def/FbEq16
01.52	<i>Current day kWh</i>	Current day energy consumption. This is the energy of the last 24 hours (not necessarily continuous) the drive has been running, not the energy of a calendar day. If the power is cycled, after the drive is again up and running, the parameter value is set to the value it had before the power cycle.	-
	0.00... 1000000.00 kWh	Energy.	1 = 1 kWh
01.53	<i>Previous day kWh</i>	Previous day energy consumption. The value <i>01.52 Current day kWh</i> is stored here when its value has been cumulated for 24 hours. If the power is cycled, after the drive is again up and running, the parameter value is set to the value it had before the power cycle.	-
	0.00... 1000000.00 kWh	Energy.	1 = 1 kWh
01.54	<i>Cumulative inverter energy</i>	Amount of energy that has passed through the drive (in either direction) in full kilowatt-hours. The minimum value is zero.	-
	-200000000.0... 200000000.0 kWh	Energy in kWh.	10 = 1 kWh
01.55	<i>Inverter GWh counter (resettable)</i>	Amount of energy that has passed through the drive (in either direction) in full gigawatt-hours. The minimum value is zero. Can be reset from the control panel by keeping Reset down for over 3 seconds. Resetting any of parameters <i>01.55...01.58</i> resets all of them.	-
	0...65535 GWh	Energy in GWh.	1 = 1 GWh
01.56	<i>Inverter MWh counter (resettable)</i>	Amount of energy that has passed through the drive (in either direction) in full megawatt-hours. Whenever the counter rolls over, <i>01.55 Inverter GWh counter (resettable)</i> is incremented. The minimum value is zero. Can be reset from the control panel by keeping Reset down for over 3 seconds. Resetting any of parameters <i>01.55...01.58</i> resets all of them.	-
	0...1000 MWh	Energy in MWh.	1 = 1 MWh
01.57	<i>Inverter kWh counter (resettable)</i>	Amount of energy that has passed through the drive (in either direction) in full kilowatt-hours. Whenever the counter rolls over, <i>01.56 Inverter MWh counter (resettable)</i> is incremented. The minimum value is zero. Can be reset from the control panel by keeping Reset down for over 3 seconds. Resetting any of parameters <i>01.55...01.58</i> resets all of them.	-
	0...1000 kWh	Energy in kWh.	10 = 1 kWh
01.58	<i>Cumulative inverter energy (resettable)</i>	Amount of energy that has passed through the drive (in either direction) in full kilowatt-hours. The minimum value is zero. Can be reset from the control panel by keeping Reset down for over 3 seconds. Resetting any of parameters <i>01.55...01.58</i> resets all of them.	-
	-200000000.0... 200000000.0 kWh	Energy in kWh.	10 = 1 kWh
01.61	<i>Abs motor speed used</i>	Absolute value of parameter <i>01.01 Motor speed used</i> .	-
	0.00... 30000.00 rpm	Estimated motor speed.	See par. <i>46.01</i>

## 202 Parameters

No.	Name/Value	Description	Def/FbEq16
<a href="#">01.62</a>	<a href="#">Abs motor speed %</a>	Absolute value of parameter <a href="#">01.03 Motor speed %</a> .	-
	0.00...1000.00%	Estimated motor speed.	10 = 1%
<a href="#">01.63</a>	<a href="#">Abs output frequency</a>	Absolute value of parameter <a href="#">01.06 Output frequency</a> .	-
	0.00...500.00 Hz	Estimated output frequency.	See par. <a href="#">46.02</a>
<a href="#">01.64</a>	<a href="#">Abs motor torque</a>	Absolute value of parameter <a href="#">01.10 Motor torque</a> .	-
	0.0...1600.0%	Motor torque.	See par. <a href="#">46.03</a>
<a href="#">01.65</a>	<a href="#">Abs output power</a>	Absolute value of parameter <a href="#">01.14 Output power</a> .	-
	0.00... 32767.00 kW	Output power.	1 = 1 kW
<a href="#">01.66</a>	<a href="#">Abs output power % motor nom</a>	Absolute value of parameter <a href="#">01.15 Output power % of motor nom</a> .	-
	0.00... 300.00%	Output power.	1 = 1%
<a href="#">01.67</a>	<a href="#">Abs output power % drive nom</a>	Absolute value of output power % of drive nominal.	-
	0.00... 300.00%	Output power.	1 = 1%
<a href="#">01.68</a>	<a href="#">Abs motor shaft power</a>	Absolute value of parameter <a href="#">01.17 Motor shaft power</a> .	-
	0.00... 32767.00 kW or hp	Motor shaft power.	1 = 1 kW
<b>03 Input references</b>		Values of references received from various sources. All parameters in this group are read-only unless otherwise noted.	
<a href="#">03.01</a>	<a href="#">Panel reference</a>	Reference 1 given from the control panel or PC tool.	-
	-100000.00... 100000.00	Control panel or PC tool reference.	1 = 10
<a href="#">03.02</a>	<a href="#">Panel reference remote</a>	Reference 2 given from the control panel or PC tool.	-
	-100000.00... 100000.00	Control panel or PC tool reference.	1 = 10
<a href="#">03.05</a>	<a href="#">FB A reference 1</a>	Reference 1 received through fieldbus adapter A. See also chapter <a href="#">Fieldbus control through a fieldbus adapter</a> (page 535).	-
	-100000.00... 100000.00	Reference 1 from fieldbus adapter A.	1 = 10
<a href="#">03.06</a>	<a href="#">FB A reference 2</a>	Reference 2 received through fieldbus adapter A.	-
	-100000.00... 100000.00	Reference 2 from fieldbus adapter A.	1 = 10
<a href="#">03.09</a>	<a href="#">EFB reference 1</a>	Scaled reference 1 received through the embedded fieldbus interface.	1 = 10
	-30000.00... 30000.00	Scaled reference 1 received through the embedded fieldbus interface.	1 = 10

No.	Name/Value	Description	Def/FbEq16
03.10	<i>EFB reference 2</i>	Scaled reference 2 received through the embedded fieldbus interface.	1 = 10
	-30000.00... 30000.00	Scaled reference 2 received through the embedded fieldbus interface.	1 = 10
<b>04 Warnings and faults</b>		Information on warnings and faults that occurred last. For explanations of individual warning and fault codes, see chapter <i>Fault tracing</i> . All parameters in this group are read-only unless otherwise noted.	
04.01	<i>Tripping fault</i>	Code of the 1st active fault (the fault that caused the current trip).	-
	0000h...FFFFh	1st active fault.	1 = 1
04.02	<i>Active fault 2</i>	Code of the 2nd active fault.	-
	0000h...FFFFh	2nd active fault.	1 = 1
04.03	<i>Active fault 3</i>	Code of the 3rd active fault.	-
	0000h...FFFFh	3rd active fault.	1 = 1
04.06	<i>Active warning 1</i>	Code of the 1st active warning.	-
	0000h...FFFFh	1st active warning.	1 = 1
04.07	<i>Active warning 2</i>	Code of the 2nd active warning.	-
	0000h...FFFFh	2nd active warning.	1 = 1
04.08	<i>Active warning 3</i>	Code of the 3rd active warning.	-
	0000h...FFFFh	3rd active warning.	1 = 1
04.11	<i>Latest fault</i>	Code of the 1st stored (non-active) fault.	-
	0000h...FFFFh	1st stored fault.	1 = 1
04.12	<i>2nd latest fault</i>	Code of the 2nd stored (non-active) fault.	-
	0000h...FFFFh	2nd stored fault.	1 = 1
04.13	<i>3rd latest fault</i>	Code of the 3rd stored (non-active) fault.	-
	0000h...FFFFh	3rd stored fault.	1 = 1
04.16	<i>Latest warning</i>	Code of the 1st stored (non-active) warning.	-
	0000h...FFFFh	1st stored warning.	1 = 1
04.17	<i>2nd latest warning</i>	Code of the 2nd stored (non-active) warning.	-
	0000h...FFFFh	2nd stored warning.	1 = 1
04.18	<i>3rd latest warning</i>	Code of the 3rd stored (non-active) warning.	-
	0000h...FFFFh	3rd stored warning.	1 = 1

No.	Name/Value	Description	Def/FbEq16															
04.40	<i>Event word 1</i>	Shows the user-defined event word. This word collects the status of the events (warnings, faults or pure events) selected by parameters <a href="#">04.41</a> ... <a href="#">04.71</a> . This parameter is read-only.	-															
<table border="1"> <thead> <tr> <th>Bit</th> <th>Name</th> <th>Description</th> </tr> </thead> <tbody> <tr> <td>0</td> <td>User bit 0</td> <td>1 = Event selected by parameter <a href="#">04.41</a> is active</td> </tr> <tr> <td>1</td> <td>User bit 1</td> <td>1 = Event selected by parameter <a href="#">04.43</a> is active</td> </tr> <tr> <td>...</td> <td>...</td> <td>...</td> </tr> <tr> <td>15</td> <td>User bit 15</td> <td>1 = Event selected by parameter <a href="#">04.71</a> is active</td> </tr> </tbody> </table>				Bit	Name	Description	0	User bit 0	1 = Event selected by parameter <a href="#">04.41</a> is active	1	User bit 1	1 = Event selected by parameter <a href="#">04.43</a> is active	...	...	...	15	User bit 15	1 = Event selected by parameter <a href="#">04.71</a> is active
Bit	Name	Description																
0	User bit 0	1 = Event selected by parameter <a href="#">04.41</a> is active																
1	User bit 1	1 = Event selected by parameter <a href="#">04.43</a> is active																
...	...	...																
15	User bit 15	1 = Event selected by parameter <a href="#">04.71</a> is active																
	0000h...FFFFh	User-defined event word.	1 = 1															
04.41	<i>Event word 1 bit 0 code</i>	Selects the hexadecimal code of an event (warning, fault or pure event) whose status is shown as bit 0 of <a href="#">04.40 Event word 1</a> . The event codes are listed in chapter <a href="#">Fault tracing</a> (page <a href="#">479</a> ).	0x2310h <a href="#">2310</a> (p. <a href="#">493</a> )															
	0000h...FFFFh	Code of event.	1 = 1															
04.43	<i>Event word 1 bit 1 code</i>	Selects the hexadecimal code of an event (warning, fault or pure event) whose status is shown as bit 1 of <a href="#">04.40 Event word 1</a> . The event codes are listed in chapter <a href="#">Fault tracing</a> (page <a href="#">479</a> ).	0x3210h <a href="#">3210</a> (p. <a href="#">494</a> )															
	0000h...FFFFh	Code of event.	1 = 1															
04.45	Event word 1 bit 2 code	...	0x4310h <a href="#">4310</a> (p. <a href="#">495</a> )															
04.47	Event word 1 bit 3 code	...	0x2340h <a href="#">2340</a> (p. <a href="#">494</a> )															
04.49	Event word 1 bit 4 code	...	0x0000h															
04.51	Event word 1 bit 5 code	...	0x3220h <a href="#">3220</a> (p. <a href="#">495</a> )															
04.53	Event word 1 bit 6 code	...	0x80A0h <a href="#">80A0</a> (p. <a href="#">501</a> )															
04.55	Event word 1 bit 7 code	...	0x0000h															
04.57	Event word 1 bit 8 code	...	0x7122h <a href="#">7122</a> (p. <a href="#">500</a> )															
04.59	Event word 1 bit 9 code	...	0x7081h <a href="#">7081</a> (p. <a href="#">499</a> )															
04.61	Event word 1 bit 10 code	...	0xFF61h <a href="#">FF61</a> (p. <a href="#">503</a> )															
04.63	Event word 1 bit 11 code	...	0x7121h <a href="#">7121</a> (p. <a href="#">499</a> )															
04.65	Event word 1 bit 12 code	...	0x4110h <a href="#">4110</a> (p. <a href="#">495</a> )															
04.67	Event word 1 bit 13 code	...	0x9081h <a href="#">9081</a> (p. <a href="#">502</a> )															
04.69	Event word 1 bit 14 code	...	0x9082h <a href="#">9082</a> (p. <a href="#">502</a> )															

No.	Name/Value	Description	Def/FbEq16
<a href="#">04.71</a>	<a href="#">Event word 1 bit 15 code</a>	Selects the hexadecimal code of an event (warning, fault or pure event) whose status is shown as bit 15 of <a href="#">04.40 Event word 1</a> . The event codes are listed in chapter <a href="#">Fault tracing</a> (page 479).	0x2330h <a href="#">2330</a> (p. 494)
	0000h...FFFFh	Code of event.	1 = 1
<b>05 Diagnostics</b>		Various run-time-type counters and measurements related to drive maintenance. All parameters in this group are read-only unless otherwise noted.	
<a href="#">05.01</a>	<a href="#">On-time counter</a>	On-time counter. The counter runs when the drive is powered.	-
	0...65535 days	On-time counter.	1 = 1 days
<a href="#">05.02</a>	<a href="#">Run-time counter</a>	Motor run-time counter in full days. The counter runs when the inverter modulates.	-
	0...65535 days	Motor run-time counter.	1 = 1 days
<a href="#">05.03</a>	<a href="#">Hours run</a>	Corresponding parameter to <a href="#">05.02 Run-time counter</a> in hours, that is, 24 * <a href="#">05.02</a> value + fractional part of a day.	-
	0.0... 429496729.5 h	Hours.	1 = 1 h
<a href="#">05.04</a>	<a href="#">Fan on-time counter</a>	Running time of the drive cooling fan. Can be reset from the control panel by keeping Reset down for over 3 seconds.	-
	0...65535 days	Cooling fan run-time counter.	1 = 1 days
<a href="#">05.08</a>	<a href="#">Cabinet temperature</a>	<i>(Only visible for ACS580-07 cabinet drives).</i> Temperature inside the cabinet. Activated by bit 6 of parameter <a href="#">95.21 HW options word 2</a> .	-
	40...120 °C or °F	Temperature inside the cabinet in degrees Celsius or Fahrenheit.	1 = 1 unit
<a href="#">05.10</a>	<a href="#">Control board temperature</a>	Measured temperature of the control unit.	-
	-100...300 °C or °F	Control unit temperature in degrees Celsius or Fahrenheit.	1 = unit
<a href="#">05.11</a>	<a href="#">Inverter temperature</a>	Estimated drive temperature in percent of fault limit. The fault limit varies according to the type of the drive. 0.0% = 0 °C (32 °F) 100.0% = Fault limit	-
	-40.0...160.0%	Drive temperature in percent.	1 = 1%

No.	Name/Value	Description	Def/FbEq16																																				
05.20	<i>Diagnostic word 1</i>	Diagnostic word 1. For possible causes and remedies, see chapter <i>Fault tracing</i> .	-																																				
<table border="1"> <thead> <tr> <th>Bit</th> <th>Name</th> <th>Value</th> </tr> </thead> <tbody> <tr> <td>0</td> <td>Any warning or fault</td> <td>Yes = Drive has generated a warning or tripped on a fault.</td> </tr> <tr> <td>1</td> <td>Any warning</td> <td>Yes = Drive has generated a warning.</td> </tr> <tr> <td>2</td> <td>Any fault</td> <td>Yes = Drive has tripped on a fault.</td> </tr> <tr> <td>3</td> <td colspan="2">Reserved</td> </tr> <tr> <td>4</td> <td>Overcurrent fault</td> <td>Yes = Drive has tripped on fault <i>2310 Overcurrent</i>.</td> </tr> <tr> <td>5</td> <td colspan="2">Reserved</td> </tr> <tr> <td>6</td> <td>DC overvoltage</td> <td>Yes = Drive has tripped on fault <i>3210 DC link overvoltage</i>.</td> </tr> <tr> <td>7</td> <td>DC undervoltage</td> <td>Yes = Drive has tripped on fault <i>3220 DC link undervoltage</i>.</td> </tr> <tr> <td>8</td> <td colspan="2">Reserved</td> </tr> <tr> <td>9</td> <td>Device overtemperature fault</td> <td>Yes = Drive has tripped on fault <i>4310 Excess temperature</i>.</td> </tr> <tr> <td>10...15</td> <td colspan="2">Reserved</td> </tr> </tbody> </table>				Bit	Name	Value	0	Any warning or fault	Yes = Drive has generated a warning or tripped on a fault.	1	Any warning	Yes = Drive has generated a warning.	2	Any fault	Yes = Drive has tripped on a fault.	3	Reserved		4	Overcurrent fault	Yes = Drive has tripped on fault <i>2310 Overcurrent</i> .	5	Reserved		6	DC overvoltage	Yes = Drive has tripped on fault <i>3210 DC link overvoltage</i> .	7	DC undervoltage	Yes = Drive has tripped on fault <i>3220 DC link undervoltage</i> .	8	Reserved		9	Device overtemperature fault	Yes = Drive has tripped on fault <i>4310 Excess temperature</i> .	10...15	Reserved	
Bit	Name	Value																																					
0	Any warning or fault	Yes = Drive has generated a warning or tripped on a fault.																																					
1	Any warning	Yes = Drive has generated a warning.																																					
2	Any fault	Yes = Drive has tripped on a fault.																																					
3	Reserved																																						
4	Overcurrent fault	Yes = Drive has tripped on fault <i>2310 Overcurrent</i> .																																					
5	Reserved																																						
6	DC overvoltage	Yes = Drive has tripped on fault <i>3210 DC link overvoltage</i> .																																					
7	DC undervoltage	Yes = Drive has tripped on fault <i>3220 DC link undervoltage</i> .																																					
8	Reserved																																						
9	Device overtemperature fault	Yes = Drive has tripped on fault <i>4310 Excess temperature</i> .																																					
10...15	Reserved																																						
0000h...FFFFh		Diagnostic word 1.	1 = 1																																				
05.21	<i>Diagnostic word 2</i>	Diagnostic word 2. For possible causes and remedies, see chapter <i>Fault tracing</i> .	-																																				
<table border="1"> <thead> <tr> <th>Bit</th> <th>Name</th> <th>Value</th> </tr> </thead> <tbody> <tr> <td>0...9</td> <td colspan="2">Reserved</td> </tr> <tr> <td>10</td> <td>Motor overtemperature fault</td> <td>Yes = Drive has tripped on fault <i>4981 External temperature 1</i> or <i>4982 Safe motor temperature</i>.</td> </tr> <tr> <td>11...15</td> <td colspan="2">Reserved</td> </tr> </tbody> </table>				Bit	Name	Value	0...9	Reserved		10	Motor overtemperature fault	Yes = Drive has tripped on fault <i>4981 External temperature 1</i> or <i>4982 Safe motor temperature</i> .	11...15	Reserved																									
Bit	Name	Value																																					
0...9	Reserved																																						
10	Motor overtemperature fault	Yes = Drive has tripped on fault <i>4981 External temperature 1</i> or <i>4982 Safe motor temperature</i> .																																					
11...15	Reserved																																						
0000h...FFFFh		Diagnostic word 2.	1 = 1																																				
05.22	<i>Diagnostic word 3</i>	Diagnostic word 3.	-																																				
<table border="1"> <thead> <tr> <th>Bit</th> <th>Name</th> <th>Value</th> </tr> </thead> <tbody> <tr> <td>0...8</td> <td colspan="2">Reserved</td> </tr> <tr> <td>9</td> <td>kWh pulse</td> <td>Yes = kWh pulse is active.</td> </tr> <tr> <td>10</td> <td colspan="2">Reserved</td> </tr> <tr> <td>11</td> <td>Fan command</td> <td>On = Drive fan is rotating above idle speed.</td> </tr> <tr> <td>12...15</td> <td colspan="2">Reserved</td> </tr> </tbody> </table>				Bit	Name	Value	0...8	Reserved		9	kWh pulse	Yes = kWh pulse is active.	10	Reserved		11	Fan command	On = Drive fan is rotating above idle speed.	12...15	Reserved																			
Bit	Name	Value																																					
0...8	Reserved																																						
9	kWh pulse	Yes = kWh pulse is active.																																					
10	Reserved																																						
11	Fan command	On = Drive fan is rotating above idle speed.																																					
12...15	Reserved																																						
0000h...FFFFh		Diagnostic word 3.	1 = 1																																				
05.80	<i>Motor speed at fault</i>	Shows the value of copy of parameter <i>28.01 Frequency ref ramp input</i> (in scalar control mode) or <i>23.01 Speed ref ramp input</i> (in speed control mode) at the occurrence of the latest fault.	-																																				
-30000.00... 30000.00 rpm		Estimated motor speed.	10 = 1 rpm																																				
05.81	<i>Output frequency at fault</i>	Shows the value of copy of parameter <i>01.06 Output frequency</i> at the occurrence of the latest fault.	-																																				

No.	Name/Value	Description	Def/FbEq16
	-500.00...500.00 Hz	Estimated output frequency.	
05.82	<i>DC voltage at fault</i>	Shows the value of copy of parameter <i>01.11 DC voltage</i> at the occurrence of the latest fault.	-
	0.00...2000.00 V	DC link voltage.	10 = 1 V
05.83	<i>Motor current at fault</i>	Shows the value of copy of parameter <i>01.07 Motor current</i> at the occurrence of the latest fault.	-
	0.00...30000.00 A	Motor current.	10 = 1 V
05.84	<i>Motor torque at fault</i>	Shows the value of copy of parameter <i>01.10 Motor torque</i> at the occurrence of the latest fault.	-
	-1600.0...1600.0%	Motor torque.	1 = 1%
05.85	<i>Main status word at fault</i>	Shows the value of copy of parameter <i>06.11 Main status word</i> at the occurrence of the latest fault.	-
	0000h...FFFFh	Main status word.	1 = 1
05.86	<i>DI delayed status at fault</i>	Shows the value of copy of parameter <i>10.02 DI delayed status</i> at the occurrence of the latest fault.	-
	0000h...FFFFh	Delayed status for digital inputs.	1 = 1
05.87	<i>Inverter temperature at fault</i>	Shows the value of copy of parameter <i>05.11 Inverter temperature</i> at the occurrence of the latest fault.	-
	-40...160 °C	Drive temperature in °C.	1 = 1 °C
05.88	<i>Reference used at fault</i>	Shows the value of copy of parameter <i>28.01 Frequency ref ramp input</i> (in scalar control mode) or <i>23.01 Speed ref ramp input</i> (in speed control mode) at the occurrence of the latest fault.	-
	-30000.00...30000.00 Hz	Frequency or speed reference.	1 = 1 Hz

No.	Name/Value	Description	Def/FbEq16																																		
<b>06 Control and status words</b>		Drive control and status words.																																			
06.01	<i>Main control word</i>	<p>Shows the control signals as received from the selected sources (such as digital inputs, the fieldbus interfaces and the application program). The main control word of the drive.</p> <p>For the bit descriptions see page 541. The related status word and state diagram are presented on pages 543 and 544 respectively.</p> <p><b>Note:</b> When using fieldbus control, this parameter value is not same as the Control word value that the drive receives from PLC. For the exact value, see parameter 50.12 FBA A debug mode.</p> <p>This parameter is read-only.</p> <table border="1" data-bbox="342 552 656 1007"> <thead> <tr> <th>Bit</th> <th>Name</th> </tr> </thead> <tbody> <tr><td>0</td><td><i>Off1 control</i></td></tr> <tr><td>1</td><td><i>Off2 control</i></td></tr> <tr><td>2</td><td><i>Off3 control</i></td></tr> <tr><td>3</td><td><i>Run</i></td></tr> <tr><td>4</td><td><i>Ramp out zero</i></td></tr> <tr><td>5</td><td><i>Ramp hold</i></td></tr> <tr><td>6</td><td><i>Ramp in zero</i></td></tr> <tr><td>7</td><td><i>Reset</i></td></tr> <tr><td>8</td><td><i>Inching 1</i></td></tr> <tr><td>9</td><td><i>Inching 2</i></td></tr> <tr><td>10</td><td><i>Remote cmd</i></td></tr> <tr><td>11</td><td><i>Ext ctrl loc</i></td></tr> <tr><td>12</td><td><i>User bit 0</i></td></tr> <tr><td>13</td><td><i>User bit 1</i></td></tr> <tr><td>14</td><td><i>User bit 2</i></td></tr> <tr><td>15</td><td><i>User bit 3</i></td></tr> </tbody> </table>	Bit	Name	0	<i>Off1 control</i>	1	<i>Off2 control</i>	2	<i>Off3 control</i>	3	<i>Run</i>	4	<i>Ramp out zero</i>	5	<i>Ramp hold</i>	6	<i>Ramp in zero</i>	7	<i>Reset</i>	8	<i>Inching 1</i>	9	<i>Inching 2</i>	10	<i>Remote cmd</i>	11	<i>Ext ctrl loc</i>	12	<i>User bit 0</i>	13	<i>User bit 1</i>	14	<i>User bit 2</i>	15	<i>User bit 3</i>	-
Bit	Name																																				
0	<i>Off1 control</i>																																				
1	<i>Off2 control</i>																																				
2	<i>Off3 control</i>																																				
3	<i>Run</i>																																				
4	<i>Ramp out zero</i>																																				
5	<i>Ramp hold</i>																																				
6	<i>Ramp in zero</i>																																				
7	<i>Reset</i>																																				
8	<i>Inching 1</i>																																				
9	<i>Inching 2</i>																																				
10	<i>Remote cmd</i>																																				
11	<i>Ext ctrl loc</i>																																				
12	<i>User bit 0</i>																																				
13	<i>User bit 1</i>																																				
14	<i>User bit 2</i>																																				
15	<i>User bit 3</i>																																				
0000h...FFFFh		Main control word.	1 = 1																																		



No.	Name/Value	Description	Def/FbEq16																																		
06.11	<i>Main status word</i>	<p>Main status word of the drive.</p> <p>For the bit descriptions see page 543. The related control word and state diagram are presented on pages 541 and 544 respectively.</p> <p><b>Note:</b> When using fieldbus control, this parameter value is not same as the Status word value that the drive sends to PLC. For the exact value, see parameter 50.12 <i>FBA A debug mode</i>.</p> <p>This parameter is read-only.</p> <table border="1" data-bbox="394 406 707 865"> <thead> <tr> <th data-bbox="394 406 468 430">Bit</th> <th data-bbox="472 406 707 430">Name</th> </tr> </thead> <tbody> <tr><td data-bbox="394 437 468 461">0</td><td data-bbox="472 437 707 461"><i>Ready to switch ON</i></td></tr> <tr><td data-bbox="394 467 468 491">1</td><td data-bbox="472 467 707 491"><i>Ready run</i></td></tr> <tr><td data-bbox="394 497 468 521">2</td><td data-bbox="472 497 707 521"><i>Ready ref</i></td></tr> <tr><td data-bbox="394 528 468 552">3</td><td data-bbox="472 528 707 552"><i>Tripped</i></td></tr> <tr><td data-bbox="394 558 468 582">4</td><td data-bbox="472 558 707 582"><i>Off 2 inactive</i></td></tr> <tr><td data-bbox="394 588 468 612">5</td><td data-bbox="472 588 707 612"><i>Off 3 inactive</i></td></tr> <tr><td data-bbox="394 619 468 643">6</td><td data-bbox="472 619 707 643"><i>Switch-on inhibited</i></td></tr> <tr><td data-bbox="394 649 468 673">7</td><td data-bbox="472 649 707 673"><i>Warning</i></td></tr> <tr><td data-bbox="394 679 468 703">8</td><td data-bbox="472 679 707 703"><i>At setpoint</i></td></tr> <tr><td data-bbox="394 710 468 734">9</td><td data-bbox="472 710 707 734"><i>Remote</i></td></tr> <tr><td data-bbox="394 740 468 764">10</td><td data-bbox="472 740 707 764"><i>Above limit</i></td></tr> <tr><td data-bbox="394 770 468 794">11</td><td data-bbox="472 770 707 794"><i>User bit 0</i></td></tr> <tr><td data-bbox="394 801 468 825">12</td><td data-bbox="472 801 707 825"><i>User bit 1</i></td></tr> <tr><td data-bbox="394 831 468 855">13</td><td data-bbox="472 831 707 855"><i>User bit 2</i></td></tr> <tr><td data-bbox="394 861 468 885">14</td><td data-bbox="472 861 707 885"><i>User bit 3</i></td></tr> <tr><td data-bbox="394 892 468 916">15</td><td data-bbox="472 892 707 916"><i>Reserved</i></td></tr> </tbody> </table>	Bit	Name	0	<i>Ready to switch ON</i>	1	<i>Ready run</i>	2	<i>Ready ref</i>	3	<i>Tripped</i>	4	<i>Off 2 inactive</i>	5	<i>Off 3 inactive</i>	6	<i>Switch-on inhibited</i>	7	<i>Warning</i>	8	<i>At setpoint</i>	9	<i>Remote</i>	10	<i>Above limit</i>	11	<i>User bit 0</i>	12	<i>User bit 1</i>	13	<i>User bit 2</i>	14	<i>User bit 3</i>	15	<i>Reserved</i>	-
Bit	Name																																				
0	<i>Ready to switch ON</i>																																				
1	<i>Ready run</i>																																				
2	<i>Ready ref</i>																																				
3	<i>Tripped</i>																																				
4	<i>Off 2 inactive</i>																																				
5	<i>Off 3 inactive</i>																																				
6	<i>Switch-on inhibited</i>																																				
7	<i>Warning</i>																																				
8	<i>At setpoint</i>																																				
9	<i>Remote</i>																																				
10	<i>Above limit</i>																																				
11	<i>User bit 0</i>																																				
12	<i>User bit 1</i>																																				
13	<i>User bit 2</i>																																				
14	<i>User bit 3</i>																																				
15	<i>Reserved</i>																																				
0000h...FFFFh	Main status word.	1 = 1																																			

## 210 Parameters

No.	Name/Value	Description	Def/FbEq16																																																			
06.16	<i>Drive status word 1</i>	Drive status word 1. This parameter is read-only.	-																																																			
<table border="1"> <thead> <tr> <th>Bit</th> <th>Name</th> <th>Description</th> </tr> </thead> <tbody> <tr> <td>0</td> <td>Enabled</td> <td>1 = Both run enable (see par. <a href="#">20.12</a>) and start enable (<a href="#">20.19</a>) signals are present. <b>Note:</b> This bit is not affected by the presence of a fault.</td> </tr> <tr> <td>1</td> <td>Inhibited</td> <td>1 = Start inhibited. To start the drive, the inhibiting signal (see par. <a href="#">06.18</a>) must be removed and the start signal cycled.</td> </tr> <tr> <td>2</td> <td>DC charged</td> <td>1 = DC circuit has been charged</td> </tr> <tr> <td>3</td> <td>Ready to start</td> <td>1 = Drive is ready to receive a start command</td> </tr> <tr> <td>4</td> <td>Following reference</td> <td>1 = Drive is ready to follow given reference</td> </tr> <tr> <td>5</td> <td>Started</td> <td>1 = Drive has been started</td> </tr> <tr> <td>6</td> <td>Modulating</td> <td>1 = Drive is modulating (output stage is being controlled)</td> </tr> <tr> <td>7</td> <td>Limiting</td> <td>1 = Any operating limit (speed, torque, etc.) is active</td> </tr> <tr> <td>8</td> <td>Local control</td> <td>1 = Drive is in local control</td> </tr> <tr> <td>9</td> <td>Network control</td> <td>1 = Drive is in <a href="#">network control</a> (see page <a href="#">18</a>).</td> </tr> <tr> <td>10</td> <td>Ext1 active</td> <td>1 = Control location EXT1 active</td> </tr> <tr> <td>11</td> <td>Ext2 active</td> <td>1 = Control location EXT2 active</td> </tr> <tr> <td>12</td> <td>Reserved</td> <td></td> </tr> <tr> <td>13</td> <td>Start request</td> <td>1 = Start requested. 0 = When Enable to rotate signal (see par. <a href="#">20.22</a>) is 0 (rotating of the motor is disabled).</td> </tr> <tr> <td>14</td> <td>Running</td> <td>1 = Drive is running.</td> </tr> <tr> <td>15</td> <td>Reserved</td> <td></td> </tr> </tbody> </table>				Bit	Name	Description	0	Enabled	1 = Both run enable (see par. <a href="#">20.12</a> ) and start enable ( <a href="#">20.19</a> ) signals are present. <b>Note:</b> This bit is not affected by the presence of a fault.	1	Inhibited	1 = Start inhibited. To start the drive, the inhibiting signal (see par. <a href="#">06.18</a> ) must be removed and the start signal cycled.	2	DC charged	1 = DC circuit has been charged	3	Ready to start	1 = Drive is ready to receive a start command	4	Following reference	1 = Drive is ready to follow given reference	5	Started	1 = Drive has been started	6	Modulating	1 = Drive is modulating (output stage is being controlled)	7	Limiting	1 = Any operating limit (speed, torque, etc.) is active	8	Local control	1 = Drive is in local control	9	Network control	1 = Drive is in <a href="#">network control</a> (see page <a href="#">18</a> ).	10	Ext1 active	1 = Control location EXT1 active	11	Ext2 active	1 = Control location EXT2 active	12	Reserved		13	Start request	1 = Start requested. 0 = When Enable to rotate signal (see par. <a href="#">20.22</a> ) is 0 (rotating of the motor is disabled).	14	Running	1 = Drive is running.	15	Reserved	
Bit	Name	Description																																																				
0	Enabled	1 = Both run enable (see par. <a href="#">20.12</a> ) and start enable ( <a href="#">20.19</a> ) signals are present. <b>Note:</b> This bit is not affected by the presence of a fault.																																																				
1	Inhibited	1 = Start inhibited. To start the drive, the inhibiting signal (see par. <a href="#">06.18</a> ) must be removed and the start signal cycled.																																																				
2	DC charged	1 = DC circuit has been charged																																																				
3	Ready to start	1 = Drive is ready to receive a start command																																																				
4	Following reference	1 = Drive is ready to follow given reference																																																				
5	Started	1 = Drive has been started																																																				
6	Modulating	1 = Drive is modulating (output stage is being controlled)																																																				
7	Limiting	1 = Any operating limit (speed, torque, etc.) is active																																																				
8	Local control	1 = Drive is in local control																																																				
9	Network control	1 = Drive is in <a href="#">network control</a> (see page <a href="#">18</a> ).																																																				
10	Ext1 active	1 = Control location EXT1 active																																																				
11	Ext2 active	1 = Control location EXT2 active																																																				
12	Reserved																																																					
13	Start request	1 = Start requested. 0 = When Enable to rotate signal (see par. <a href="#">20.22</a> ) is 0 (rotating of the motor is disabled).																																																				
14	Running	1 = Drive is running.																																																				
15	Reserved																																																					
0000h...FFFFh		Drive status word 1.	1 = 1																																																			

No.	Name/Value	Description	Def/FbEq16																																													
06.17	Drive status word 2	Drive status word 2. This parameter is read-only.	-																																													
<table border="1"> <thead> <tr> <th>Bit</th> <th>Name</th> <th>Description</th> </tr> </thead> <tbody> <tr> <td>0</td> <td>Identification run done</td> <td>1 = Motor identification (ID) run has been performed</td> </tr> <tr> <td>1</td> <td>Magnetized</td> <td>1 = The motor has been magnetized</td> </tr> <tr> <td>2</td> <td>Torque control</td> <td>1 = Torque control mode active</td> </tr> <tr> <td>3</td> <td>Speed control</td> <td>1 = Speed control mode active</td> </tr> <tr> <td>4</td> <td>Reserved</td> <td></td> </tr> <tr> <td>5</td> <td>Safe reference active</td> <td>1 = A "safe" reference is applied by functions such as parameters <a href="#">49.05</a> and <a href="#">50.02</a></td> </tr> <tr> <td>6</td> <td>Last speed active</td> <td>1 = A "last speed" reference is applied by functions such as parameters <a href="#">49.05</a> and <a href="#">50.02</a></td> </tr> <tr> <td>7</td> <td>Reserved</td> <td></td> </tr> <tr> <td>8</td> <td>Emergency stop failed</td> <td>1 = Emergency stop failed (see parameters <a href="#">31.32</a> and <a href="#">31.33</a>)</td> </tr> <tr> <td>9</td> <td>Jogging active</td> <td>1 = Jogging enable signal is on</td> </tr> <tr> <td>10</td> <td>Above limit</td> <td>1 = Actual speed or frequency equals or exceeds limit (defined by parameters <a href="#">46.31</a>...<a href="#">46.32</a>). Valid in both directions of rotation.</td> </tr> <tr> <td>11...12</td> <td>Reserved</td> <td></td> </tr> <tr> <td>13</td> <td>Start delay active</td> <td>1 = Start delay (par. <a href="#">21.22</a>) active.</td> </tr> <tr> <td>14...15</td> <td>Reserved</td> <td></td> </tr> </tbody> </table>				Bit	Name	Description	0	Identification run done	1 = Motor identification (ID) run has been performed	1	Magnetized	1 = The motor has been magnetized	2	Torque control	1 = Torque control mode active	3	Speed control	1 = Speed control mode active	4	Reserved		5	Safe reference active	1 = A "safe" reference is applied by functions such as parameters <a href="#">49.05</a> and <a href="#">50.02</a>	6	Last speed active	1 = A "last speed" reference is applied by functions such as parameters <a href="#">49.05</a> and <a href="#">50.02</a>	7	Reserved		8	Emergency stop failed	1 = Emergency stop failed (see parameters <a href="#">31.32</a> and <a href="#">31.33</a> )	9	Jogging active	1 = Jogging enable signal is on	10	Above limit	1 = Actual speed or frequency equals or exceeds limit (defined by parameters <a href="#">46.31</a> ... <a href="#">46.32</a> ). Valid in both directions of rotation.	11...12	Reserved		13	Start delay active	1 = Start delay (par. <a href="#">21.22</a> ) active.	14...15	Reserved	
Bit	Name	Description																																														
0	Identification run done	1 = Motor identification (ID) run has been performed																																														
1	Magnetized	1 = The motor has been magnetized																																														
2	Torque control	1 = Torque control mode active																																														
3	Speed control	1 = Speed control mode active																																														
4	Reserved																																															
5	Safe reference active	1 = A "safe" reference is applied by functions such as parameters <a href="#">49.05</a> and <a href="#">50.02</a>																																														
6	Last speed active	1 = A "last speed" reference is applied by functions such as parameters <a href="#">49.05</a> and <a href="#">50.02</a>																																														
7	Reserved																																															
8	Emergency stop failed	1 = Emergency stop failed (see parameters <a href="#">31.32</a> and <a href="#">31.33</a> )																																														
9	Jogging active	1 = Jogging enable signal is on																																														
10	Above limit	1 = Actual speed or frequency equals or exceeds limit (defined by parameters <a href="#">46.31</a> ... <a href="#">46.32</a> ). Valid in both directions of rotation.																																														
11...12	Reserved																																															
13	Start delay active	1 = Start delay (par. <a href="#">21.22</a> ) active.																																														
14...15	Reserved																																															
0000h...FFFFh		Drive status word 2.	1 = 1																																													

## 212 Parameters

No.	Name/Value	Description	Def/FbEq16
06.18	<i>Start inhibit status word</i>	Start inhibit status word. This word specifies the source of the inhibiting signal that is preventing the drive from starting. The conditions marked with an asterisk (*) only require that the start command is cycled. In all other instances, the inhibiting condition must be removed first. See also parameter <i>06.16 Drive status word 1</i> , bit 1. This parameter is read-only.	-

Bit	Name	Description
0	Not ready run	1 = DC voltage is missing or drive has not been parametrized correctly. Check the parameters in groups 95 and 99.
1	Ctrl location changed	* 1 = Control location has changed
2	SSW inhibit	1 = Control program is keeping itself in inhibited state
3	Fault reset	* 1 = A fault has been reset
4	Lost start enable	1 = Start enable signal missing
5	Lost run enable	1 = Run enable signal missing
6	Reserved	
7	STO	1 = Safe torque off function active
8	Current calibration ended	* 1 = Current calibration routine has finished
9	ID run ended	* 1 = Motor identification run has finished
10	Reserved	
11	Em Off1	1 = Emergency stop signal (mode off1)
12	Em Off2	1 = Emergency stop signal (mode off2)
13	Em Off3	1 = Emergency stop signal (mode off3)
14	Auto reset inhibit	1 = The autoreset function is inhibiting operation
15	Jogging active	1 = The jogging enable signal is inhibiting operation

0000h...FFFFh      Start inhibit status word.      1 = 1

06.19	<i>Speed control status word</i>	Speed control status word. This parameter is read-only.	-
-------	----------------------------------	---	---

Bit	Name	Description
0	Zero speed	1 = Drive has been running below zero speed limit (par. <a href="#">21.06</a> ) for a time defined by parameter <a href="#">21.07 Zero speed delay</a>
1	Forward	1 = Drive is running in forward direction above zero speed limit (par. <a href="#">21.06</a> )
2	Reverse	1 = Drive is running in reverse direction above zero speed limit (par. <a href="#">21.06</a> )
3...6	Reserved	
7	Any constant speed request	1 = A constant speed or frequency has been selected; see par. <a href="#">06.20</a> .
8...15	Reserved	

0000h...FFFFh      Speed control status word.      1 = 1

No.	Name/Value	Description	Def/FbEq16																											
06.20	<i>Constant speed status word</i>	Constant speed/frequency status word. Indicates which constant speed or frequency is active (if any). See also parameter <i>06.19 Speed control status word</i> , bit 7, and section <i>Constant speeds/frequencies</i> (page 124). This parameter is read-only.	-																											
		<table border="1"> <thead> <tr> <th>Bit</th> <th>Name</th> <th>Description</th> </tr> </thead> <tbody> <tr> <td>0</td> <td>Constant speed 1</td> <td>1 = Constant speed or frequency 1 selected</td> </tr> <tr> <td>1</td> <td>Constant speed 2</td> <td>1 = Constant speed or frequency 2 selected</td> </tr> <tr> <td>2</td> <td>Constant speed 3</td> <td>1 = Constant speed or frequency 3 selected</td> </tr> <tr> <td>3</td> <td>Constant speed 4</td> <td>1 = Constant speed or frequency 4 selected</td> </tr> <tr> <td>4</td> <td>Constant speed 5</td> <td>1 = Constant speed or frequency 5 selected</td> </tr> <tr> <td>5</td> <td>Constant speed 6</td> <td>1 = Constant speed or frequency 6 selected</td> </tr> <tr> <td>6</td> <td>Constant speed 7</td> <td>1 = Constant speed or frequency 7 selected</td> </tr> <tr> <td>7...15</td> <td>Reserved</td> <td></td> </tr> </tbody> </table>	Bit	Name	Description	0	Constant speed 1	1 = Constant speed or frequency 1 selected	1	Constant speed 2	1 = Constant speed or frequency 2 selected	2	Constant speed 3	1 = Constant speed or frequency 3 selected	3	Constant speed 4	1 = Constant speed or frequency 4 selected	4	Constant speed 5	1 = Constant speed or frequency 5 selected	5	Constant speed 6	1 = Constant speed or frequency 6 selected	6	Constant speed 7	1 = Constant speed or frequency 7 selected	7...15	Reserved		
Bit	Name	Description																												
0	Constant speed 1	1 = Constant speed or frequency 1 selected																												
1	Constant speed 2	1 = Constant speed or frequency 2 selected																												
2	Constant speed 3	1 = Constant speed or frequency 3 selected																												
3	Constant speed 4	1 = Constant speed or frequency 4 selected																												
4	Constant speed 5	1 = Constant speed or frequency 5 selected																												
5	Constant speed 6	1 = Constant speed or frequency 6 selected																												
6	Constant speed 7	1 = Constant speed or frequency 7 selected																												
7...15	Reserved																													
	0000h...FFFFh	Constant speed/frequency status word.	1 = 1																											
06.21	<i>Drive status word 3</i>	Drive status word 3. This parameter is read-only.	-																											
		<table border="1"> <thead> <tr> <th>Bit</th> <th>Name</th> <th>Description</th> </tr> </thead> <tbody> <tr> <td>0</td> <td>DC hold active</td> <td>1 = DC hold is active</td> </tr> <tr> <td>1</td> <td>Post-magnetizing active</td> <td>1 = Post-magnetizing is active</td> </tr> <tr> <td>2</td> <td>Motor pre-heating active</td> <td>1 = Motor pre-heating is active</td> </tr> <tr> <td>3</td> <td>PM smooth start active</td> <td>1 = PM smooth start active</td> </tr> <tr> <td>4</td> <td>Reserved</td> <td></td> </tr> <tr> <td>5</td> <td>DC brake active</td> <td>1 = Brake is active</td> </tr> <tr> <td>6...15</td> <td>Reserved</td> <td></td> </tr> </tbody> </table>	Bit	Name	Description	0	DC hold active	1 = DC hold is active	1	Post-magnetizing active	1 = Post-magnetizing is active	2	Motor pre-heating active	1 = Motor pre-heating is active	3	PM smooth start active	1 = PM smooth start active	4	Reserved		5	DC brake active	1 = Brake is active	6...15	Reserved					
Bit	Name	Description																												
0	DC hold active	1 = DC hold is active																												
1	Post-magnetizing active	1 = Post-magnetizing is active																												
2	Motor pre-heating active	1 = Motor pre-heating is active																												
3	PM smooth start active	1 = PM smooth start active																												
4	Reserved																													
5	DC brake active	1 = Brake is active																												
6...15	Reserved																													
	0000h...FFFFh	Drive status word 1.	1 = 1																											
	0000h...FFFFh	Start inhibit status word.	1 = 1																											
06.29	<i>MSW bit 10 selection</i>	Selects a binary source whose status is transmitted as bit 10 (User bit 0) of <i>06.11 Main status word</i> .	<i>Above limit</i>																											
	False	0.	0																											
	True	1.	1																											
	Above limit	Bit 10 of <i>06.17 Drive status word 2</i> (see page 211).	2																											
	<i>Other [bit]</i>	Source selection (see <i>Terms and abbreviations</i> on page 196).	-																											
06.30	<i>MSW bit 11 selection</i>	Selects a binary source whose status is transmitted as bit 11 (User bit 0) of <i>06.11 Main status word</i> .	<i>Ext ctrl loc</i>																											
	False	0.	0																											
	True	1.	1																											
	Ext ctrl loc	Bit 11 of <i>06.01 Main control word</i> (see page 209).	2																											
	<i>Other [bit]</i>	Source selection (see <i>Terms and abbreviations</i> on page 196).	-																											

No.	Name/Value	Description	Def/FbEq16
06.31	<i>MSW bit 12 selection</i>	Selects a binary source whose status is transmitted as bit 12 (User bit 1) of <i>06.11 Main status word</i> .	<i>Ext run enable</i>
	False	0.	0
	True	1.	1
	Ext run enable	Status of the external run enable signal (see parameter <i>20.12 Run enable 1 source</i> ).	2
	<i>Other [bit]</i>	Source selection (see <i>Terms and abbreviations</i> on page 196).	-
06.32	<i>MSW bit 13 selection</i>	Selects a binary source whose status is transmitted as bit 13 (User bit 2) of <i>06.11 Main status word</i> .	<i>False</i>
	False	0.	0
	True	1.	1
	<i>Other [bit]</i>	Source selection (see <i>Terms and abbreviations</i> on page 196).	-
06.33	<i>MSW bit 14 selection</i>	Selects a binary source whose status is transmitted as bit 14 (User bit 3) of <i>06.11 Main status word</i> .	<i>False</i>
	False	0.	0
	True	1.	1
	<i>Other [bit]</i>	Source selection (see <i>Terms and abbreviations</i> on page 196).	-

<b>07 System info</b>		Drive hardware and firmware information. All parameters in this group are read-only.	
07.03	<i>Drive rating id</i>	Type of the drive. (Rating ID in brackets.)	-
07.04	<i>Firmware name</i>	Firmware identification.	-
07.05	<i>Firmware version</i>	Version number of the firmware.	-
07.06	<i>Loading package name</i>	Name of the firmware loading package.	-
07.07	<i>Loading package version</i>	Version number of the firmware loading package.	-
07.10	<i>Language file set</i>	The language file set (language package) in use, see parameter <i>96.01 Language</i> . The language file set value is written to this parameter after the first start-up, and it is available in this parameter through power-ups.	-
	Not known	No language file set in use.	0
	Global	Global language file set in use.	1
	European	European language file set in use.	2
	Asian	Asian language file set in use.	3
07.11	<i>Cpu usage</i>	Microprocessor load in percent.	-
	0...100%	Microprocessor load.	1 = 1%
07.25	<i>Customization package name</i>	First five ASCII letters of the name given to the customization package. The full name is visible in the <b>System info</b> menu under the <b>Main</b> menu on the control panel or the Drive composer PC tool. _N/A_ = None.	-
07.26	<i>Customization package version</i>	Customization package version number. Also visible in the <b>System info</b> menu under the <b>Main</b> menu on the control panel or the Drive composer PC tool.	-

No.	Name/Value	Description	Def/FbEq16																																													
07.30	<i>Adaptive program status</i>	Shows the status of the adaptive program. See section <i>Adaptive programming</i> (page 117).	-																																													
<table border="1"> <thead> <tr> <th>Bit</th> <th>Name</th> <th>Description</th> </tr> </thead> <tbody> <tr> <td>0</td> <td>Initialized</td> <td>1 = Adaptive program initialized</td> </tr> <tr> <td>1</td> <td>Editing</td> <td>1 = Adaptive program is being edited</td> </tr> <tr> <td>2</td> <td>Edit done</td> <td>1 = Editing of adaptive program finished</td> </tr> <tr> <td>3</td> <td>Running</td> <td>1 = Adaptive program running</td> </tr> <tr> <td>4...13</td> <td>Reserved</td> <td></td> </tr> <tr> <td>14</td> <td>State changing</td> <td>1 = State change in progress in adaptive programming engine</td> </tr> <tr> <td>15</td> <td>Faulted</td> <td>1 = Error in adaptive program</td> </tr> </tbody> </table>				Bit	Name	Description	0	Initialized	1 = Adaptive program initialized	1	Editing	1 = Adaptive program is being edited	2	Edit done	1 = Editing of adaptive program finished	3	Running	1 = Adaptive program running	4...13	Reserved		14	State changing	1 = State change in progress in adaptive programming engine	15	Faulted	1 = Error in adaptive program																					
Bit	Name	Description																																														
0	Initialized	1 = Adaptive program initialized																																														
1	Editing	1 = Adaptive program is being edited																																														
2	Edit done	1 = Editing of adaptive program finished																																														
3	Running	1 = Adaptive program running																																														
4...13	Reserved																																															
14	State changing	1 = State change in progress in adaptive programming engine																																														
15	Faulted	1 = Error in adaptive program																																														
0000h...FFFFh		Adaptive program status.	1 = 1																																													
07.31	<i>AP sequence state</i>	Shows the number of the active state of the sequence program part of the adaptive program (AP). If adaptive programming is not running, or it does not contain a sequence program, the parameter is zero.																																														
0...20			1 = 1																																													
07.35	<i>Drive configuration</i>	Performs HW initialization, and shows the detected option module configuration of the drive. Plug 'n' play configuration during the HW initialization, if the drive is not able to detect any option module, the value is set to 1, Base unit. For information on automatic setting of parameters after detecting a module, see section <i>Automatic drive configuration for fieldbus control</i> on page 548.	0000h																																													
<table border="1"> <thead> <tr> <th>Bit</th> <th>Name</th> <th>Description</th> </tr> </thead> <tbody> <tr> <td>0</td> <td>Not initialized</td> <td>1 = Drive configuration has not been initialized</td> </tr> <tr> <td>1</td> <td>Base unit</td> <td>1 = Drive has not detected any option modules, that is, there is only the base unit.</td> </tr> <tr> <td>2</td> <td>Reserved</td> <td></td> </tr> <tr> <td>3</td> <td>FENA-21</td> <td>1 = FENA-21 Two-port Ethernet adapter module included</td> </tr> <tr> <td>4</td> <td>FECA-01</td> <td>1 = FECA-01 EtherCAT adapter module included</td> </tr> <tr> <td>5</td> <td>FPBA-01</td> <td>1 = FPBA-01 PROFIBUS DP adapter module included</td> </tr> <tr> <td>6</td> <td>FCAN-01</td> <td>1 = FCAN-01 CANopen adapter module included</td> </tr> <tr> <td>7...9</td> <td>Reserved</td> <td></td> </tr> <tr> <td>10</td> <td>FSCA-01</td> <td>1 = FSCA-01 Modbus/RTU adapter module included</td> </tr> <tr> <td>11</td> <td>FEIP-21</td> <td>1 = FEIP-21 Two-port EtherNet/IP adapter module included</td> </tr> <tr> <td>12</td> <td>FMBT-21</td> <td>1 = FMBT-21 Two-port Modbus/TCP adapter module included</td> </tr> <tr> <td>13</td> <td>Reserved</td> <td></td> </tr> <tr> <td>14</td> <td>FPNO-21</td> <td>1 = FPNO-21 Two-port PROFINET IO adapter module included</td> </tr> <tr> <td>15</td> <td>FEPL-02</td> <td>1 = FEPL-02 Ethernet POWERLINK adapter module included</td> </tr> </tbody> </table>				Bit	Name	Description	0	Not initialized	1 = Drive configuration has not been initialized	1	Base unit	1 = Drive has not detected any option modules, that is, there is only the base unit.	2	Reserved		3	FENA-21	1 = FENA-21 Two-port Ethernet adapter module included	4	FECA-01	1 = FECA-01 EtherCAT adapter module included	5	FPBA-01	1 = FPBA-01 PROFIBUS DP adapter module included	6	FCAN-01	1 = FCAN-01 CANopen adapter module included	7...9	Reserved		10	FSCA-01	1 = FSCA-01 Modbus/RTU adapter module included	11	FEIP-21	1 = FEIP-21 Two-port EtherNet/IP adapter module included	12	FMBT-21	1 = FMBT-21 Two-port Modbus/TCP adapter module included	13	Reserved		14	FPNO-21	1 = FPNO-21 Two-port PROFINET IO adapter module included	15	FEPL-02	1 = FEPL-02 Ethernet POWERLINK adapter module included
Bit	Name	Description																																														
0	Not initialized	1 = Drive configuration has not been initialized																																														
1	Base unit	1 = Drive has not detected any option modules, that is, there is only the base unit.																																														
2	Reserved																																															
3	FENA-21	1 = FENA-21 Two-port Ethernet adapter module included																																														
4	FECA-01	1 = FECA-01 EtherCAT adapter module included																																														
5	FPBA-01	1 = FPBA-01 PROFIBUS DP adapter module included																																														
6	FCAN-01	1 = FCAN-01 CANopen adapter module included																																														
7...9	Reserved																																															
10	FSCA-01	1 = FSCA-01 Modbus/RTU adapter module included																																														
11	FEIP-21	1 = FEIP-21 Two-port EtherNet/IP adapter module included																																														
12	FMBT-21	1 = FMBT-21 Two-port Modbus/TCP adapter module included																																														
13	Reserved																																															
14	FPNO-21	1 = FPNO-21 Two-port PROFINET IO adapter module included																																														
15	FEPL-02	1 = FEPL-02 Ethernet POWERLINK adapter module included																																														
000h...FFFFh		Drive configuration	1 = 1																																													
07.36	<i>Drive configuration 2</i>	Shows the detected module configuration. See parameter <a href="#">07.35 Drive configuration</a> .	0000h																																													

No.	Name/Value	Description	Def/FbEq16																														
<table border="1"> <thead> <tr> <th>Bit</th> <th>Name</th> <th>Description</th> </tr> </thead> <tbody> <tr> <td>0</td> <td>Reserved</td> <td></td> </tr> <tr> <td>1</td> <td>FDNA-01</td> <td>1 = FDNA-01 DeviceNet™ adapter module included</td> </tr> <tr> <td>2</td> <td>FCNA-01</td> <td>1 = FCNA-01 ControlNet™ adapter module included</td> </tr> <tr> <td>3</td> <td>CMOD-01</td> <td>1 = CMOD-01 adapter module included</td> </tr> <tr> <td>4</td> <td>CMOD-02</td> <td>1 = CMOD-02 adapter module included</td> </tr> <tr> <td>5</td> <td>CPTC-02</td> <td>1 = CPTC-02 adapter module included</td> </tr> <tr> <td>6</td> <td>CHDI-01</td> <td>1 = CHDI-01 adapter module included</td> </tr> <tr> <td>7</td> <td>FSPS-21</td> <td>1 = FSPS-21 adapter module included</td> </tr> <tr> <td>8...15</td> <td>Reserved</td> <td></td> </tr> </tbody> </table>				Bit	Name	Description	0	Reserved		1	FDNA-01	1 = FDNA-01 DeviceNet™ adapter module included	2	FCNA-01	1 = FCNA-01 ControlNet™ adapter module included	3	CMOD-01	1 = CMOD-01 adapter module included	4	CMOD-02	1 = CMOD-02 adapter module included	5	CPTC-02	1 = CPTC-02 adapter module included	6	CHDI-01	1 = CHDI-01 adapter module included	7	FSPS-21	1 = FSPS-21 adapter module included	8...15	Reserved	
Bit	Name	Description																															
0	Reserved																																
1	FDNA-01	1 = FDNA-01 DeviceNet™ adapter module included																															
2	FCNA-01	1 = FCNA-01 ControlNet™ adapter module included																															
3	CMOD-01	1 = CMOD-01 adapter module included																															
4	CMOD-02	1 = CMOD-02 adapter module included																															
5	CPTC-02	1 = CPTC-02 adapter module included																															
6	CHDI-01	1 = CHDI-01 adapter module included																															
7	FSPS-21	1 = FSPS-21 adapter module included																															
8...15	Reserved																																
0000h...FFFFh	Drive configuration		1 = 1																														

10 Standard DI, RO		Configuration of digital inputs and relay outputs.																									
10.01	DI status	<p>Displays the electrical status of digital inputs DI1...DI6. The activation/deactivation delays of the inputs (if any are specified) are ignored.</p> <p>Bits 0...5 reflect the status of DI1...DI6.</p> <p><b>Example:</b> 0000000000010011b = DI5, DI2 and DI1 are on, DI3, DI4 and DI6 are off.</p> <p>This parameter is read-only.</p>	-																								
<table border="1"> <thead> <tr> <th>Bit</th> <th>Name</th> <th>Description</th> </tr> </thead> <tbody> <tr> <td>0</td> <td>DI1</td> <td>1 = Digital input 1 is ON.</td> </tr> <tr> <td>1</td> <td>DI2</td> <td>1 = Digital input 2 is ON.</td> </tr> <tr> <td>2</td> <td>DI3</td> <td>1 = Digital input 3 is ON.</td> </tr> <tr> <td>3</td> <td>DI4</td> <td>1 = Digital input 4 is ON.</td> </tr> <tr> <td>4</td> <td>DI5</td> <td>1 = Digital input 5 is ON.</td> </tr> <tr> <td>5</td> <td>DI6</td> <td>1 = Digital input 6 is ON.</td> </tr> <tr> <td>6...15</td> <td>Reserved</td> <td></td> </tr> </tbody> </table>				Bit	Name	Description	0	DI1	1 = Digital input 1 is ON.	1	DI2	1 = Digital input 2 is ON.	2	DI3	1 = Digital input 3 is ON.	3	DI4	1 = Digital input 4 is ON.	4	DI5	1 = Digital input 5 is ON.	5	DI6	1 = Digital input 6 is ON.	6...15	Reserved	
Bit	Name	Description																									
0	DI1	1 = Digital input 1 is ON.																									
1	DI2	1 = Digital input 2 is ON.																									
2	DI3	1 = Digital input 3 is ON.																									
3	DI4	1 = Digital input 4 is ON.																									
4	DI5	1 = Digital input 5 is ON.																									
5	DI6	1 = Digital input 6 is ON.																									
6...15	Reserved																										
0000h...FFFFh	Status for digital inputs.		1 = 1																								



No.	Name/Value	Description	Def/FbEq16																								
10.02	<i>DI delayed status</i>	<p>Displays the delayed status of digital inputs DI1...DI6. Bits 0...5 reflect the delayed status of DI1...DI6.</p> <p><b>Example:</b> 0000000000010011b = DI5, DI2 and DI1 are on, DI3, DI4 and DI6 are off.</p> <p>This word is updated only after a 2 ms activation/deactivation delay. When the value of a digital input changes, it must remain the same in two consecutive samples, that is, for 2 ms, for the new value to be accepted.</p> <p>This parameter is read-only.</p>	-																								
<table border="1"> <thead> <tr> <th>Bit</th> <th>Name</th> <th>Description</th> </tr> </thead> <tbody> <tr> <td>0</td> <td>DI1</td> <td>1 = Digital input 1 is ON.</td> </tr> <tr> <td>1</td> <td>DI2</td> <td>1 = Digital input 2 is ON.</td> </tr> <tr> <td>2</td> <td>DI3</td> <td>1 = Digital input 3 is ON.</td> </tr> <tr> <td>3</td> <td>DI4</td> <td>1 = Digital input 4 is ON.</td> </tr> <tr> <td>4</td> <td>DI5</td> <td>1 = Digital input 5 is ON.</td> </tr> <tr> <td>5</td> <td>DI6</td> <td>1 = Digital input 6 is ON.</td> </tr> <tr> <td>6...15</td> <td colspan="2">Reserved</td> </tr> </tbody> </table>				Bit	Name	Description	0	DI1	1 = Digital input 1 is ON.	1	DI2	1 = Digital input 2 is ON.	2	DI3	1 = Digital input 3 is ON.	3	DI4	1 = Digital input 4 is ON.	4	DI5	1 = Digital input 5 is ON.	5	DI6	1 = Digital input 6 is ON.	6...15	Reserved	
Bit	Name	Description																									
0	DI1	1 = Digital input 1 is ON.																									
1	DI2	1 = Digital input 2 is ON.																									
2	DI3	1 = Digital input 3 is ON.																									
3	DI4	1 = Digital input 4 is ON.																									
4	DI5	1 = Digital input 5 is ON.																									
5	DI6	1 = Digital input 6 is ON.																									
6...15	Reserved																										
0000h...FFFFh		Delayed status for digital inputs.	1 = 1																								
10.03	<i>DI force selection</i>	<p>The electrical statuses of the digital inputs can be overridden, for example, testing purposes. A bit in parameter <i>10.04 DI forced data</i> is provided for each digital input, and its value is applied whenever the corresponding bit in this parameter is 1.</p> <p><b>Note:</b> Boot and power cycle reset the force selections (parameters <i>10.03</i> and <i>10.04</i>).</p>	0000h																								
<table border="1"> <thead> <tr> <th>Bit</th> <th>Name</th> <th>Value</th> </tr> </thead> <tbody> <tr> <td>0</td> <td>DI1</td> <td>1 = Force DI1 to value of bit 0 of parameter <i>10.04 DI forced data</i>. (0 = Normal mode)</td> </tr> <tr> <td>1</td> <td>DI2</td> <td>1 = Force DI2 to value of bit 1 of parameter <i>10.04 DI forced data</i>. (0 = Normal mode)</td> </tr> <tr> <td>2</td> <td>DI3</td> <td>1 = Force DI3 to value of bit 2 of parameter <i>10.04 DI forced data</i>. (0 = Normal mode)</td> </tr> <tr> <td>3</td> <td>DI4</td> <td>1 = Force DI4 to value of bit 3 of parameter <i>10.04 DI forced data</i>. (0 = Normal mode)</td> </tr> <tr> <td>4</td> <td>DI5</td> <td>1 = Force DI5 to value of bit 4 of parameter <i>10.04 DI forced data</i>. (0 = Normal mode)</td> </tr> <tr> <td>5</td> <td>DI6</td> <td>1 = Force DI6 to value of bit 5 of parameter <i>10.04 DI forced data</i>. (0 = Normal mode)</td> </tr> <tr> <td>6...15</td> <td colspan="2">Reserved</td> </tr> </tbody> </table>				Bit	Name	Value	0	DI1	1 = Force DI1 to value of bit 0 of parameter <i>10.04 DI forced data</i> . (0 = Normal mode)	1	DI2	1 = Force DI2 to value of bit 1 of parameter <i>10.04 DI forced data</i> . (0 = Normal mode)	2	DI3	1 = Force DI3 to value of bit 2 of parameter <i>10.04 DI forced data</i> . (0 = Normal mode)	3	DI4	1 = Force DI4 to value of bit 3 of parameter <i>10.04 DI forced data</i> . (0 = Normal mode)	4	DI5	1 = Force DI5 to value of bit 4 of parameter <i>10.04 DI forced data</i> . (0 = Normal mode)	5	DI6	1 = Force DI6 to value of bit 5 of parameter <i>10.04 DI forced data</i> . (0 = Normal mode)	6...15	Reserved	
Bit	Name	Value																									
0	DI1	1 = Force DI1 to value of bit 0 of parameter <i>10.04 DI forced data</i> . (0 = Normal mode)																									
1	DI2	1 = Force DI2 to value of bit 1 of parameter <i>10.04 DI forced data</i> . (0 = Normal mode)																									
2	DI3	1 = Force DI3 to value of bit 2 of parameter <i>10.04 DI forced data</i> . (0 = Normal mode)																									
3	DI4	1 = Force DI4 to value of bit 3 of parameter <i>10.04 DI forced data</i> . (0 = Normal mode)																									
4	DI5	1 = Force DI5 to value of bit 4 of parameter <i>10.04 DI forced data</i> . (0 = Normal mode)																									
5	DI6	1 = Force DI6 to value of bit 5 of parameter <i>10.04 DI forced data</i> . (0 = Normal mode)																									
6...15	Reserved																										
0000h...FFFFh		Override selection for digital inputs.	1 = 1																								

No.	Name/Value	Description	Def/FbEq16																								
10.04	<i>DI forced data</i>	Allows the data value of a forced digital input to be changed from 0 to 1. It is only possible to force an input that has been selected in parameter <a href="#">10.03 DI force selection</a> .	0000h																								
<table border="1"> <thead> <tr> <th>Bit</th> <th>Name</th> <th>Value</th> </tr> </thead> <tbody> <tr> <td>0</td> <td>DI1</td> <td>Force the value of this bit to D1, if so defined in parameter <a href="#">10.03 DI force selection</a>.</td> </tr> <tr> <td>1</td> <td>DI2</td> <td>Force the value of this bit to D3, if so defined in parameter <a href="#">10.03 DI force selection</a>.</td> </tr> <tr> <td>2</td> <td>DI3</td> <td>Force the value of this bit to D3, if so defined in parameter <a href="#">10.03 DI force selection</a>.</td> </tr> <tr> <td>3</td> <td>DI4</td> <td>Force the value of this bit to D4, if so defined in parameter <a href="#">10.03 DI force selection</a>.</td> </tr> <tr> <td>4</td> <td>DI5</td> <td>Force the value of this bit to D5, if so defined in parameter <a href="#">10.03 DI force selection</a>.</td> </tr> <tr> <td>5</td> <td>DI6</td> <td>Force the value of this bit to D6, if so defined in parameter <a href="#">10.03 DI force selection</a>.</td> </tr> <tr> <td>6...15</td> <td colspan="2">Reserved</td> </tr> </tbody> </table>				Bit	Name	Value	0	DI1	Force the value of this bit to D1, if so defined in parameter <a href="#">10.03 DI force selection</a> .	1	DI2	Force the value of this bit to D3, if so defined in parameter <a href="#">10.03 DI force selection</a> .	2	DI3	Force the value of this bit to D3, if so defined in parameter <a href="#">10.03 DI force selection</a> .	3	DI4	Force the value of this bit to D4, if so defined in parameter <a href="#">10.03 DI force selection</a> .	4	DI5	Force the value of this bit to D5, if so defined in parameter <a href="#">10.03 DI force selection</a> .	5	DI6	Force the value of this bit to D6, if so defined in parameter <a href="#">10.03 DI force selection</a> .	6...15	Reserved	
Bit	Name	Value																									
0	DI1	Force the value of this bit to D1, if so defined in parameter <a href="#">10.03 DI force selection</a> .																									
1	DI2	Force the value of this bit to D3, if so defined in parameter <a href="#">10.03 DI force selection</a> .																									
2	DI3	Force the value of this bit to D3, if so defined in parameter <a href="#">10.03 DI force selection</a> .																									
3	DI4	Force the value of this bit to D4, if so defined in parameter <a href="#">10.03 DI force selection</a> .																									
4	DI5	Force the value of this bit to D5, if so defined in parameter <a href="#">10.03 DI force selection</a> .																									
5	DI6	Force the value of this bit to D6, if so defined in parameter <a href="#">10.03 DI force selection</a> .																									
6...15	Reserved																										
	0000h...FFFFh	Forced values of digital inputs.	1 = 1																								
10.05	<i>DI1 ON delay</i>	Defines the activation delay for digital input DI1.	0.00 s																								
<p> <math>t_{On} = 10.05 DI1 ON delay</math>  <math>t_{Off} = 10.06 DI1 OFF delay</math>                      *Electrical status of digital input. Indicated by <a href="#">10.01 DI status</a>.                      **Indicated by <a href="#">10.02 DI delayed status</a>.                 </p>																											
	0.00 ... 3000.00 s	Activation delay for DI1.	10 = 1 s																								
10.06	<i>DI1 OFF delay</i>	Defines the deactivation delay for digital input DI1. See parameter <a href="#">10.05 DI1 ON delay</a> .	0.00 s																								
	0.00 ... 3000.00 s	Deactivation delay for DI1.	10 = 1 s																								
10.07	<i>DI2 ON delay</i>	Defines the activation delay for digital input DI2.	0.00 s																								
<p> <math>t_{On} = 10.07 DI2 ON delay</math>  <math>t_{Off} = 10.08 DI2 OFF delay</math>                      *Electrical status of digital input. Indicated by <a href="#">10.01 DI status</a>.                      **Indicated by <a href="#">10.02 DI delayed status</a>.                 </p>																											
	0.00 ... 3000.00 s	Activation delay for DI2.	10 = 1 s																								

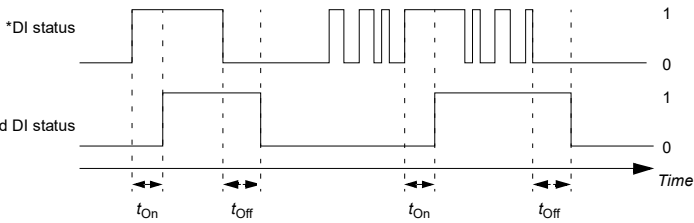
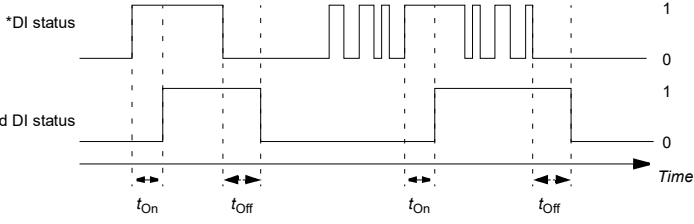
No.	Name/Value	Description	Def/FbEq16
10.08	<i>DI2 OFF delay</i>	Defines the deactivation delay for digital input DI2. See parameter <a href="#">10.07 DI2 ON delay</a> .	0.00 s
	0.00 ... 3000.00 s	Deactivation delay for DI2.	10 = 1 s
10.09	<i>DI3 ON delay</i>	Defines the activation delay for digital input DI3.	0.00 s
		 <p> <math>t_{On} = 10.09 \text{ DI3 ON delay}</math>  <math>t_{Off} = 10.10 \text{ DI3 OFF delay}</math>            *Electrical status of digital input. Indicated by <a href="#">10.01 DI status</a>.            **Indicated by <a href="#">10.02 DI delayed status</a>.         </p>	
	0.00 ... 3000.00 s	Activation delay for DI3.	10 = 1 s
10.10	<i>DI3 OFF delay</i>	Defines the deactivation delay for digital input DI3. See parameter <a href="#">10.09 DI3 ON delay</a> .	0.00 s
	0.00 ... 3000.00 s	Deactivation delay for DI3.	10 = 1 s
10.11	<i>DI4 ON delay</i>	Defines the activation delay for digital input DI4.	0.00 s
		 <p> <math>t_{On} = 10.11 \text{ DI4 ON delay}</math>  <math>t_{Off} = 10.12 \text{ DI4 OFF delay}</math>            *Electrical status of digital input. Indicated by <a href="#">10.01 DI status</a>.            **Indicated by <a href="#">10.02 DI delayed status</a>.         </p>	
	0.00 ... 3000.00 s	Activation delay for DI4.	10 = 1 s
10.12	<i>DI4 OFF delay</i>	Defines the deactivation delay for digital input DI4. See parameter <a href="#">10.11 DI4 ON delay</a> .	0.00 s
	0.00 ... 3000.00 s	Deactivation delay for DI4.	10 = 1 s

No.	Name/Value	Description	Def/FbEq16															
10.13	<a href="#">DI5 ON delay</a>	Defines the activation delay for digital input DI5.	0.00 s															
<p><math>t_{On} = 10.13</math> <a href="#">DI5 ON delay</a>  <math>t_{Off} = 10.14</math> <a href="#">DI5 OFF delay</a>                      *Electrical status of digital input. Indicated by <a href="#">10.01 DI status</a>.                      **Indicated by <a href="#">10.02 DI delayed status</a>.</p>																		
	0.00 ... 3000.00 s	Activation delay for DI5.	10 = 1 s															
10.14	<a href="#">DI5 OFF delay</a>	Defines the deactivation delay for digital input DI5. See parameter <a href="#">10.13 DI5 ON delay</a> .	0.00 s															
	0.00 ... 3000.00 s	Deactivation delay for DI5.	10 = 1 s															
10.15	<a href="#">DI6 ON delay</a>	Defines the activation delay for digital input DI6.	0.00 s															
<p><math>t_{On} = 10.15</math> <a href="#">DI6 ON delay</a>  <math>t_{Off} = 10.16</math> <a href="#">DI6 OFF delay</a>                      *Electrical status of digital input. Indicated by <a href="#">10.01 DI status</a>.                      **Indicated by <a href="#">10.02 DI delayed status</a>.</p>																		
	0.00 ... 3000.00 s	Activation delay for DI6.	10 = 1 s															
10.16	<a href="#">DI6 OFF delay</a>	Defines the deactivation delay for digital input DI6. See parameter <a href="#">10.15 DI6 ON delay</a> .	0.00 s															
	0.00 ... 3000.00 s	Deactivation delay for DI6.	10 = 1 s															
10.21	<a href="#">RO status</a>	Status of relay outputs RO3...RO1.	-															
<table border="1"> <thead> <tr> <th>Bit</th> <th>Name</th> <th>Value</th> </tr> </thead> <tbody> <tr> <td>0</td> <td>RO1</td> <td>1 = energized, 0 = de-energized.</td> </tr> <tr> <td>1</td> <td>RO2</td> <td>1 = energized, 0 = de-energized</td> </tr> <tr> <td>2</td> <td>RO3</td> <td>1 = energized, 0 = de-energized</td> </tr> <tr> <td>3...15</td> <td>Reserved</td> <td></td> </tr> </tbody> </table>				Bit	Name	Value	0	RO1	1 = energized, 0 = de-energized.	1	RO2	1 = energized, 0 = de-energized	2	RO3	1 = energized, 0 = de-energized	3...15	Reserved	
Bit	Name	Value																
0	RO1	1 = energized, 0 = de-energized.																
1	RO2	1 = energized, 0 = de-energized																
2	RO3	1 = energized, 0 = de-energized																
3...15	Reserved																	
	0000h...FFFFh	Status of relay outputs.	1 = 1															

No.	Name/Value	Description	Def/FbEq16															
10.22	<i>RO force selection</i>	The signals connected to the relay outputs can be overridden, for example, testing purposes. A bit in parameter <i>10.23 RO forced data</i> is provided for each relay output, and its value is applied whenever the corresponding bit in this parameter is 1. <b>Note:</b> Boot and power cycle reset the force selections (parameters <i>10.22</i> and <i>10.23</i> ).	0000h															
<table border="1"> <thead> <tr> <th>Bit</th> <th>Name</th> <th>Value</th> </tr> </thead> <tbody> <tr> <td>0</td> <td>RO1</td> <td>1 = Force RO1 to value of bit 0 of parameter <i>10.23 RO forced data</i>. (0 = Normal mode)</td> </tr> <tr> <td>1</td> <td>RO2</td> <td>1 = Force RO2 to value of bit 1 of parameter <i>10.23 RO forced data</i>. (0 = Normal mode)</td> </tr> <tr> <td>2</td> <td>RO3</td> <td>1 = Force RO3 to value of bit 2 of parameter <i>10.23 RO forced data</i>. (0 = Normal mode)</td> </tr> <tr> <td>3...15</td> <td colspan="2">Reserved</td> </tr> </tbody> </table>				Bit	Name	Value	0	RO1	1 = Force RO1 to value of bit 0 of parameter <i>10.23 RO forced data</i> . (0 = Normal mode)	1	RO2	1 = Force RO2 to value of bit 1 of parameter <i>10.23 RO forced data</i> . (0 = Normal mode)	2	RO3	1 = Force RO3 to value of bit 2 of parameter <i>10.23 RO forced data</i> . (0 = Normal mode)	3...15	Reserved	
Bit	Name	Value																
0	RO1	1 = Force RO1 to value of bit 0 of parameter <i>10.23 RO forced data</i> . (0 = Normal mode)																
1	RO2	1 = Force RO2 to value of bit 1 of parameter <i>10.23 RO forced data</i> . (0 = Normal mode)																
2	RO3	1 = Force RO3 to value of bit 2 of parameter <i>10.23 RO forced data</i> . (0 = Normal mode)																
3...15	Reserved																	
0000h...FFFFh		Override selection for relay outputs.	1 = 1															
10.23	<i>RO forced data</i>	Contains the values of relay outputs that are used instead of the connected signals if selected in parameter <i>10.22 RO force selection</i> . Bit 0 is the forced value for RO1.																
<table border="1"> <thead> <tr> <th>Bit</th> <th>Name</th> <th>Value</th> </tr> </thead> <tbody> <tr> <td>0</td> <td>RO1</td> <td>Force the value of this bit to RO1, if so defined in parameter <i>10.22 RO force selection</i>.</td> </tr> <tr> <td>1</td> <td>RO2</td> <td>Force the value of this bit to RO2, if so defined in parameter <i>10.22 RO force selection</i>.</td> </tr> <tr> <td>2</td> <td>RO3</td> <td>Force the value of this bit to RO3, if so defined in parameter <i>10.22 RO force selection</i>.</td> </tr> <tr> <td>3...15</td> <td colspan="2">Reserved</td> </tr> </tbody> </table>				Bit	Name	Value	0	RO1	Force the value of this bit to RO1, if so defined in parameter <i>10.22 RO force selection</i> .	1	RO2	Force the value of this bit to RO2, if so defined in parameter <i>10.22 RO force selection</i> .	2	RO3	Force the value of this bit to RO3, if so defined in parameter <i>10.22 RO force selection</i> .	3...15	Reserved	
Bit	Name	Value																
0	RO1	Force the value of this bit to RO1, if so defined in parameter <i>10.22 RO force selection</i> .																
1	RO2	Force the value of this bit to RO2, if so defined in parameter <i>10.22 RO force selection</i> .																
2	RO3	Force the value of this bit to RO3, if so defined in parameter <i>10.22 RO force selection</i> .																
3...15	Reserved																	
0000h...FFFFh		Forced RO values.	1 = 1															
10.24	<i>RO1 source</i>	Selects a drive signal to be connected to relay output RO1.	<i>Ready run</i>															
Not energized		Output is not energized.	0															
Energized		Output is energized.	1															
Ready run		Bit 1 of <i>06.11 Main status word</i> (see page 209).	2															
Enabled		Bit 0 of <i>06.16 Drive status word 1</i> (see page 210).	4															
Started		Bit 5 of <i>06.16 Drive status word 1</i> (see page 210).	5															
Magnetized		Bit 1 of <i>06.17 Drive status word 2</i> (see page 211).	6															
Running		Bit 6 of <i>06.16 Drive status word 1</i> (see page 210).	7															
Ready ref		Bit 2 of <i>06.11 Main status word</i> (see page 209).	8															
At setpoint		Bit 8 of <i>06.11 Main status word</i> (see page 209).	9															
Reverse		Bit 2 of <i>06.19 Speed control status word</i> (see page 212).	10															
Zero speed		Bit 0 of <i>06.19 Speed control status word</i> (see page 212).	11															
Above limit		Bit 10 of <i>06.17 Drive status word 2</i> (see page 211).	12															
Warning		Bit 7 of <i>06.11 Main status word</i> (see page 209).	13															
Fault		Bit 3 of <i>06.11 Main status word</i> (see page 209).	14															
Fault (-1)		Inverted bit 3 of <i>06.11 Main status word</i> (see page 209).	15															
Fault/Warning		Bit 3 of <i>06.11 Main status word</i> OR bit 7 of <i>06.11 Main status word</i> (see page 209).	16															

## 222 Parameters

No.	Name/Value	Description	Def/FbEq16
	Overcurrent	Fault <a href="#">2310 Overcurrent</a> has occurred.	17
	Overvoltage	Fault <a href="#">3210 DC link overvoltage</a> has occurred.	18
	Drive temp	Fault <a href="#">2381 IGBT overload</a> or <a href="#">4110 Control board temperature</a> or <a href="#">4210 IGBT overtemperature</a> or <a href="#">4290 Cooling</a> or <a href="#">42F1 IGBT temperature</a> or <a href="#">4310 Excess temperature</a> or <a href="#">4380 Excess temperature difference</a> has occurred.	19
	Undervoltage	Fault <a href="#">3220 DC link undervoltage</a> has occurred.	20
	Motor temp	Fault <a href="#">4981 External temperature 1</a> or <a href="#">4982 External temperature 2</a> has occurred.	21
	Brake command	Bit 0 of <a href="#">44.01 Brake control status</a> (see page <a href="#">373</a> ).	22
	Ext2 active	Bit 11 of <a href="#">06.16 Drive status word 1</a> (see page <a href="#">210</a> ).	23
	Remote control	Bit 9 of <a href="#">06.11 Main status word</a> (see page <a href="#">209</a> ).	24
	Reserved		25...26
	Timed function 1	Bit 0 of <a href="#">34.01 Timed functions status</a> (see page <a href="#">327</a> ).	27
	Timed function 2	Bit 1 of <a href="#">34.01 Timed functions status</a> (see page <a href="#">327</a> ).	28
	Timed function 3	Bit 2 of <a href="#">34.01 Timed functions status</a> (see page <a href="#">327</a> ).	29
	Reserved		30...32
	Supervision 1	Bit 0 of <a href="#">32.01 Supervision status</a> (see page <a href="#">319</a> ).	33
	Supervision 2	Bit 1 of <a href="#">32.01 Supervision status</a> (see page <a href="#">319</a> ).	34
	Supervision 3	Bit 2 of <a href="#">32.01 Supervision status</a> (see page <a href="#">319</a> ).	35
	Reserved		36...38
	Start delay	Bit 13 of <a href="#">06.17 Drive status word 2</a> (see page <a href="#">211</a> ).	39
	RO/DIO control word bit0	Bit 0 of <a href="#">10.99 RO/DIO control word</a> (see page <a href="#">224</a> ).	40
	RO/DIO control word bit1	Bit 1 of <a href="#">10.99 RO/DIO control word</a> (see page <a href="#">224</a> ).	41
	RO/DIO control word bit2	Bit 2 of <a href="#">10.99 RO/DIO control word</a> (see page <a href="#">224</a> ).	42
	Reserved		43...44
	PFC1	Bit 0 of <a href="#">76.01 PFC status</a> (see page <a href="#">403</a> ).	45
	PFC2	Bit 1 of <a href="#">76.01 PFC status</a> (see page <a href="#">403</a> ).	46
	PFC3	Bit 2 of <a href="#">76.01 PFC status</a> (see page <a href="#">403</a> ).	47
	PFC4	Bit 3 of <a href="#">76.01 PFC status</a> (see page <a href="#">403</a> ).	48
	PFC5	Bit 3 of <a href="#">76.01 PFC status</a> (see page <a href="#">403</a> ).	49
	PFC6	Bit 3 of <a href="#">76.01 PFC status</a> (see page <a href="#">403</a> ).	50
	Event word 1	Event word 1 = 1 if any bit of <a href="#">04.40 Event word 1</a> (see page <a href="#">204</a> ) is 1, that is, if any warning, fault or pure event that has been defined with parameters <a href="#">04.41...04.71</a> is on.	53
	User load curve	Bit 3 (Outside load limit) of <a href="#">37.01 ULC output status word</a> (see page <a href="#">349</a> ).	61
	RO/DIO control word	<a href="#">For 10.24 RO1 source</a> : Bit 0 (RO1) of <a href="#">10.99 RO/DIO control word</a> (see page <a href="#">224</a> ). <a href="#">For 10.27 RO2 source</a> : Bit 1 (RO2) of <a href="#">10.99 RO/DIO control word</a> (see page <a href="#">224</a> ). <a href="#">For 10.30 RO3 source</a> : Bit 2 (RO3) of <a href="#">10.99 RO/DIO control word</a> (see page <a href="#">224</a> ).	62

No.	Name/Value	Description	Def/FbEq16
	<a href="#">Other [bit]</a>	Source selection (see <a href="#">Terms and abbreviations</a> on page 196).	-
10.25	<a href="#">RO1 ON delay</a>	Defines the activation delay for relay output RO1.	0.0 s
		<p> <math>t_{On} = 10.25</math> <a href="#">RO1 ON delay</a>  <math>t_{Off} = 10.26</math> <a href="#">RO1 OFF delay</a> </p>	
	0.0 ... 3000.0 s	Activation delay for RO1.	10 = 1 s
10.26	<a href="#">RO1 OFF delay</a>	Defines the deactivation delay for relay output RO1. See parameter <a href="#">10.25 RO1 ON delay</a> .	0.0 s
	0.0 ... 3000.0 s	Deactivation delay for RO1.	10 = 1 s
10.27	<a href="#">RO2 source</a>	Selects a drive signal to be connected to relay output RO2. For the available selections, see parameter <a href="#">10.24 RO1 source</a> .	<a href="#">Running</a>
10.28	<a href="#">RO2 ON delay</a>	Defines the activation delay for relay output RO2.	0.0 s
		<p> <math>t_{On} = 10.28</math> <a href="#">RO2 ON delay</a>  <math>t_{Off} = 10.29</math> <a href="#">RO2 OFF delay</a> </p>	
	0.0 ... 3000.0 s	Activation delay for RO2.	10 = 1 s
10.29	<a href="#">RO2 OFF delay</a>	Defines the deactivation delay for relay output RO2. See parameter <a href="#">10.28 RO2 ON delay</a> .	0.0 s
	0.0 ... 3000.0 s	Deactivation delay for RO2.	10 = 1 s
10.30	<a href="#">RO3 source</a>	Selects a drive signal to be connected to relay output RO3. For the available selections, see parameter <a href="#">10.24 RO1 source</a> .	<a href="#">Fault (-1)</a>

No.	Name/Value	Description	Def/FbEq16																								
10.31	<i>RO3 ON delay</i>	Defines the activation delay for relay output RO3.	0.0 s																								
<p> <math>t_{On} = 10.31</math> RO3 ON delay  <math>t_{Off} = 10.32</math> RO3 OFF delay                 </p>																											
	0.0 ... 3000.0 s	Activation delay for RO3.	10 = 1 s																								
10.32	<i>RO3 OFF delay</i>	Defines the deactivation delay for relay output RO3. See parameter <a href="#">10.31 RO3 ON delay</a> .	0.0 s																								
	0.0 ... 3000.0 s	Deactivation delay for RO3.	10 = 1 s																								
10.99	<i>RO/DIO control word</i>	Storage parameter for controlling the relay outputs, for example, through the embedded fieldbus interface. To control the relay outputs (RO) of the drive, send a control word with the bit assignments shown below as Modbus I/O data. Set the target selection parameter of that particular data ( <a href="#">58.101...58.114</a> ) to <i>RO/DIO control word</i> . In the source selection parameter of the desired output, select the appropriate bit of this word.	0000h																								
<table border="1"> <thead> <tr> <th>Bit</th> <th>Name</th> <th>Description</th> </tr> </thead> <tbody> <tr> <td>0</td> <td>RO1</td> <td rowspan="3">Source bits for relay outputs RO1...RO3. See parameters <a href="#">10.24</a>, <a href="#">10.27</a> and <a href="#">10.30</a>.</td> </tr> <tr> <td>1</td> <td>RO2</td> </tr> <tr> <td>2</td> <td>RO3</td> </tr> <tr> <td>3</td> <td>RO4</td> <td rowspan="2">Source bits for relay outputs RO4...RO5 with a CHDI-01 or CMOD-01 extension module. See parameters <a href="#">15.07</a> and <a href="#">15.10</a>.</td> </tr> <tr> <td>4</td> <td>RO5</td> </tr> <tr> <td>5...7</td> <td colspan="2">Reserved</td> </tr> <tr> <td>8</td> <td>DIO1</td> <td>Source bit for digital output DO1 with a CMOD-01 extension module. See parameter <a href="#">15.23</a>.</td> </tr> <tr> <td>9...15</td> <td colspan="2">Reserved</td> </tr> </tbody> </table>				Bit	Name	Description	0	RO1	Source bits for relay outputs RO1...RO3. See parameters <a href="#">10.24</a> , <a href="#">10.27</a> and <a href="#">10.30</a> .	1	RO2	2	RO3	3	RO4	Source bits for relay outputs RO4...RO5 with a CHDI-01 or CMOD-01 extension module. See parameters <a href="#">15.07</a> and <a href="#">15.10</a> .	4	RO5	5...7	Reserved		8	DIO1	Source bit for digital output DO1 with a CMOD-01 extension module. See parameter <a href="#">15.23</a> .	9...15	Reserved	
Bit	Name	Description																									
0	RO1	Source bits for relay outputs RO1...RO3. See parameters <a href="#">10.24</a> , <a href="#">10.27</a> and <a href="#">10.30</a> .																									
1	RO2																										
2	RO3																										
3	RO4	Source bits for relay outputs RO4...RO5 with a CHDI-01 or CMOD-01 extension module. See parameters <a href="#">15.07</a> and <a href="#">15.10</a> .																									
4	RO5																										
5...7	Reserved																										
8	DIO1	Source bit for digital output DO1 with a CMOD-01 extension module. See parameter <a href="#">15.23</a> .																									
9...15	Reserved																										
	0000h...FFFFh	RO/DIO control word.	1 = 1																								
10.101	<i>RO1 toggle counter</i>	Displays the number of times relay output RO1 has changed states. Can be reset from the control panel by keeping Reset down for over 3 seconds.	-																								
	0...4294967000	State change count.	1 = 1																								
10.102	<i>RO2 toggle counter</i>	Displays the number of times relay output RO2 has changed states. Can be reset from the control panel by keeping Reset down for over 3 seconds.	-																								
	0...4294967000	State change count.	1 = 1																								
10.103	<i>RO3 toggle counter</i>	Displays the number of times relay output RO3 has changed states. Can be reset from the control panel by keeping Reset down for over 3 seconds.	-																								
	0...4294967000	State change count.	1 = 1																								

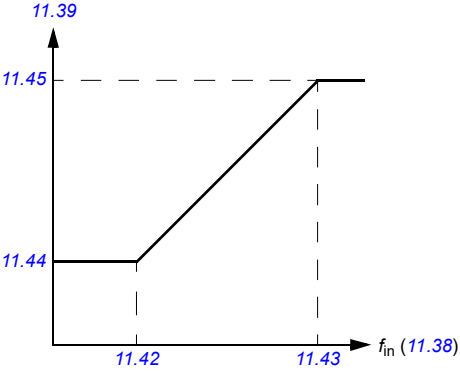

No.	Name/Value	Description	Def/FbEq16
<b>11 Standard DIO, FI, FO</b>			
<b>11.21</b>	<b><i>DI5 configuration</i></b>	Selects how digital input 5 is used.	<i>Digital input</i>
	Digital input	DI5 is used as a digital input.	0
	Frequency input	DI5 is used as a frequency input.	1
<b>11.38</b>	<b><i>Freq in 1 actual value</i></b>	Displays the value of frequency input 1 (via DI5 when it is used as a frequency input) before scaling. See parameter <b>11.42 <i>Freq in 1 min.</i></b> This parameter is read-only.	-
	0 ... 16000 Hz	Unscaled value of frequency input 1.	1 = 1 Hz
<b>11.39</b>	<b><i>Freq in 1 scaled value</i></b>	Displays the value of frequency input 1 (via DI5 when it is used as a frequency input) after scaling. See parameter <b>11.42 <i>Freq in 1 min.</i></b> This parameter is read-only.	-
	-32768.000... 32767.000	Scaled value of frequency input 1 (DI5).	1 = 1
<b>11.42</b>	<b><i>Freq in 1 min</i></b>	Defines the minimum for the frequency actually arriving at frequency input 1 (DI5 when it is used as a frequency input). The incoming frequency signal ( <b>11.38 <i>Freq in 1 actual value</i></b> ) is scaled into an internal signal ( <b>11.39 <i>Freq in 1 scaled value</i></b> ) by parameters <b>11.42...11.45</b> as follows:  	0 Hz
	0 ... 16000 Hz	Minimum frequency of frequency input 1 (DI5).	1 = 1 Hz
<b>11.43</b>	<b><i>Freq in 1 max</i></b>	Defines the maximum for the frequency actually arriving at frequency input 1 (DI5 when it is used as a frequency input). See parameter <b>11.42 <i>Freq in 1 min.v</i></b>	16000 Hz
	0 ... 16000 Hz	Maximum frequency for frequency input 1 (DI5).	1 = 1 Hz
<b>11.44</b>	<b><i>Freq in 1 at scaled min</i></b>	Defines the value that is required to correspond internally to the minimum input frequency defined by parameter <b>11.42 <i>Freq in 1 min.</i></b> See diagram at parameter <b>11.42 <i>Freq in 1 min.</i></b>	0.000
	-32768.000... 32767.000	Value corresponding to minimum of frequency input 1.	1 = 1

No.	Name/Value	Description	Def/FbEq16
11.45	<i>Freq in 1 at scaled max</i>	Defines the value that is required to correspond internally to the maximum input frequency defined by parameter <a href="#">11.43 Freq in 1 max</a> . See diagram at parameter <a href="#">11.42 Freq in 1 min</a> .	1500.000; 1800.000 (95.20 b0)
	-32768.000... 32767.000	Value corresponding to maximum of frequency input 1.	1 = 1

**12 Standard AI**

Configuration of standard analog inputs.

**12.02 AI force selection**

The true readings of the analog inputs can be overridden, for example, for testing purposes. A forced value parameter is provided for each analog input, and its value is applied whenever the corresponding bit in this parameter is 1.  
**Note:** AI filter times (parameters [12.16 AI1 filter time](#) and [12.26 AI2 filter time](#)) have no effect on forced AI values (parameters [12.13 AI1 forced value](#) and [12.23 AI2 forced value](#)).  
**Note:** Boot and power cycle reset the force selections (parameters [12.02](#) and [12.03](#)).

0000h

Bit	Name	Value
0	AI1	1 = Force AI1 to value of parameter <a href="#">12.13 AI1 forced value</a> .
1	AI2	1 = Force AI2 to value of parameter <a href="#">12.23 AI2 forced value</a> .
2...15	Reserved	

0000h...FFFFh

Forced values selector for analog inputs AI1 and AI2.

1 = 1

**12.03 AI supervision function**

Selects how the drive reacts when an analog input signal moves out of the minimum and/or maximum limits specified for the input.  
 The supervision applies a margin of 0.5 V or 1.0 mA to the limits. For example, if the maximum limit for the input is 7.000 V, the maximum limit supervision activates at 7.500 V. The inputs and the limits to be observed are selected by parameter [12.04 AI supervision selection](#).

*No action*

No action

No action taken.

0

Fault

Drive trips on [80A0 AI supervision](#).

1

Warning

Drive generates an [A8A0 AI supervision](#) warning.

2

Last speed

Drive generates a warning ([A8A0 AI supervision](#)) and freezes the speed (or frequency) to the level the drive was operating at. The speed/frequency is determined on the basis of actual speed using 850 ms low-pass filtering.

3



**WARNING!** Make sure that it is safe to continue operation in case of a communication break.

Speed ref safe

Drive generates a warning ([A8A0 AI supervision](#)) and sets the speed to the speed defined by parameter [22.41 Speed ref safe](#) (or [28.41 Frequency ref safe](#) when frequency reference is being used).

4



**WARNING!** Make sure that it is safe to continue operation in case of a communication break.

No.	Name/Value	Description	Def/FbEq16																		
12.04	<i>AI supervision selection</i>	Specifies the analog input limits to be supervised. See parameter <a href="#">12.03 AI supervision function</a> .	0000h																		
		<table border="1"> <thead> <tr> <th>Bit</th> <th>Name</th> <th>Description</th> </tr> </thead> <tbody> <tr> <td>0</td> <td>AI1 &lt; MIN</td> <td>1 = Minimum limit supervision of AI1 active.</td> </tr> <tr> <td>1</td> <td>AI1 &gt; MAX</td> <td>1 = Maximum limit supervision of AI1 active.</td> </tr> <tr> <td>2</td> <td>AI2 &lt; MIN</td> <td>1 = Minimum limit supervision of AI2 active.</td> </tr> <tr> <td>3</td> <td>AI2 &gt; MAX</td> <td>1 = Maximum limit supervision of AI2 active.</td> </tr> <tr> <td>4...15</td> <td>Reserved</td> <td></td> </tr> </tbody> </table>	Bit	Name	Description	0	AI1 < MIN	1 = Minimum limit supervision of AI1 active.	1	AI1 > MAX	1 = Maximum limit supervision of AI1 active.	2	AI2 < MIN	1 = Minimum limit supervision of AI2 active.	3	AI2 > MAX	1 = Maximum limit supervision of AI2 active.	4...15	Reserved		
Bit	Name	Description																			
0	AI1 < MIN	1 = Minimum limit supervision of AI1 active.																			
1	AI1 > MAX	1 = Maximum limit supervision of AI1 active.																			
2	AI2 < MIN	1 = Minimum limit supervision of AI2 active.																			
3	AI2 > MAX	1 = Maximum limit supervision of AI2 active.																			
4...15	Reserved																				
	0000h...FFFFh	Activation of analog input supervision.	1 = 1																		
12.11	<i>AI1 actual value</i>	Displays the value of analog input AI1 in mA or V (depending on whether the input is set to current or voltage with parameter <a href="#">12.15 AI1 unit selection</a> ). This parameter is read-only.	-																		
	0.000...22.000 mA or 0.000...11.000 V	Value of analog input AI1.	1000 = 1 unit																		
12.12	<i>AI1 scaled value</i>	Displays the value of analog input AI1 after scaling. See parameters <a href="#">12.19 AI1 scaled at AI1 min</a> and <a href="#">12.20 AI1 scaled at AI1 max</a> . This parameter is read-only.	-																		
	-32768.000... 32767.000	Scaled value of analog input AI1.	1 = 1																		
12.13	<i>AI1 forced value</i>	Forced value that can be used instead of the true reading of the input. See parameter <a href="#">12.02 AI force selection</a> .	-																		
	0.000...22.000 mA or 0.000...11.000 V	Forced value of analog input AI1.	1000 = 1 unit																		
12.15	<i>AI1 unit selection</i>	Selects the unit for readings and settings related to analog input AI1.	V																		
	V	Volts.	2																		
	mA	Milliamperes.	10																		

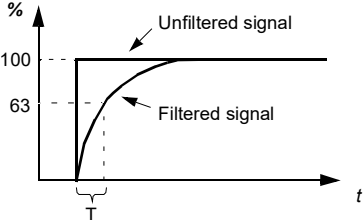
No.	Name/Value	Description	Def/FbEq16
12.16	<i>AI1 filter time</i>	<p>Defines the filter time constant for analog input AI1.</p>  <p style="text-align: center;"><math>O = I \times (1 - e^{-t/T})</math></p> <p>I = filter input (step)  O = filter output  t = time  T = filter time constant</p> <p><b>Note:</b> The signal is also filtered due to the signal interface hardware (approximately 0.25 ms time constant). This cannot be changed by any parameter.</p>	0.100 s
	0.000...30.000 s	Filter time constant.	1000 = 1 s
12.17	<i>AI1 min</i>	<p>Defines the minimum site value for analog input AI1.  Set the value actually sent to the drive when the analog signal from plant is wound to its minimum setting.  See also parameter <a href="#">12.19 AI1 scaled at AI1 min.</a></p>	4.000 mA or 0.000 V
	0.000...22.000 mA or 0.000...11.000 V	Minimum value of AI1.	1000 = 1 unit
12.18	<i>AI1 max</i>	<p>Defines the maximum site value for analog input AI1.  Set the value actually sent to the drive when the analog signal from plant is wound to its maximum setting.  See also parameter <a href="#">12.19 AI1 scaled at AI1 min.</a></p>	20.000 mA or 10.000 V
	0.000...22.000 mA or 0.000...11.000 V	Maximum value of AI1.	1000 = 1 unit

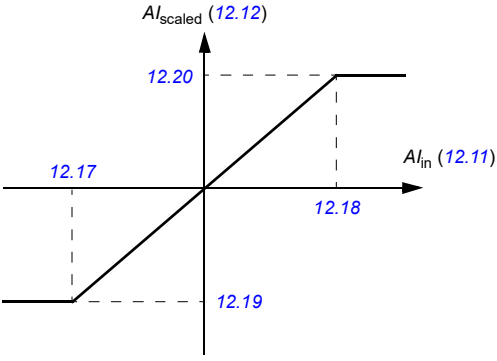
No.	Name/Value	Description	Def/FbEq16
12.19	<i>AI1 scaled at AI1 min</i>	Defines the real internal value that corresponds to the minimum analog input AI1 value defined by parameter <a href="#">12.17 AI1 min</a> . (Changing the polarity settings of <a href="#">12.19</a> and <a href="#">12.20</a> can effectively invert the analog input.) 	0.000
	-32768.000... 32767.000	Real value corresponding to minimum AI1 value.	1 = 1
12.20	<i>AI1 scaled at AI1 max</i>	Defines the real internal value that corresponds to the maximum analog input AI1 value defined by parameter <a href="#">12.18 AI1 max</a> . See the drawing at parameter <a href="#">12.19 AI1 scaled at AI1 min</a> .	50.000; 60.000 (95.20 b0)
	-32768.000... 32767.000	Real value corresponding to maximum AI1 value.	1 = 1
12.21	<i>AI2 actual value</i>	Displays the value of analog input AI2 in mA or V (depending on whether the input is set to current or voltage with parameter <a href="#">12.25 AI2 unit selection</a> ). This parameter is read-only.	-
	0.000...22.000 mA or 0.000...11.000 V	Value of analog input AI2.	1000 = 1 unit
12.22	<i>AI2 scaled value</i>	Displays the value of analog input AI2 after scaling. See parameters <a href="#">12.29 AI2 scaled at AI2 min</a> and <a href="#">12.101 AI1 percent value</a> . This parameter is read-only.	-
	-32768.000... 32767.000	Scaled value of analog input AI2.	1 = 1
12.23	<i>AI2 forced value</i>	Forced value that can be used instead of the true reading of the input. See parameter <a href="#">12.02 AI force selection</a> .	-
	0.000...22.000 mA or 0.000...11.000 V	Forced value of analog input AI2.	1000 = 1 unit
12.25	<i>AI2 unit selection</i>	Selects the unit for readings and settings related to analog input AI2.	<i>mA</i>
	V	Volts.	2
	mA	Milliamperes.	10
12.26	<i>AI2 filter time</i>	Defines the filter time constant for analog input AI2. See parameter <a href="#">12.16 AI1 filter time</a> .	0.100 s
	0.000...30.000 s	Filter time constant.	1000 = 1 s

230 Parameters

No.	Name/Value	Description	Def/FbEq16
12.27	<i>AI2 min</i>	Defines the minimum site value for analog input AI2. Set the value actually sent to the drive when the analog signal from plant is wound to its minimum setting.	4.000 mA or 0.000 V
	0.000...22.000 mA or 0.000...11.000 V	Minimum value of AI2.	1000 = 1 unit
12.28	<i>AI2 max</i>	Defines the maximum site value for analog input AI2. Set the value actually sent to the drive when the analog signal from plant is wound to its maximum setting.	20.000 mA or 10.000 V
	0.000...22.000 mA or 0.000...11.000 V	Maximum value of AI2.	1000 = 1 unit
12.29	<i>AI2 scaled at AI2 min</i>	Defines the real value that corresponds to the minimum analog input AI2 value defined by parameter <i>12.27 AI2 min</i> . (Changing the polarity settings of <i>12.29</i> and <i>12.101</i> can effectively invert the analog input.)	0.000
	-32768.000... 32767.000	Real value corresponding to minimum AI2 value.	1 = 1
12.30	<i>AI2 scaled at AI2 max</i>	Defines the real value that corresponds to the minimum analog input AI2 value defined by parameter <i>12.28 AI2 max</i> . See the drawing at parameter of <i>12.29 AI2 scaled at AI2 min</i> .	50.000
	-32768.000... 32767.000	Real value corresponding to maximum AI2 value.	1 = 1
12.101	<i>AI1 percent value</i>	Value of analog input AI1 in percent of AI1 scaling ( <i>12.18 AI1 max</i> - <i>12.17 AI1 min</i> ).	-
	0.00...100.00%	AI1 value	100 = 1%
12.102	<i>AI2 percent value</i>	Value of analog input AI2 in percent of AI2 scaling ( <i>12.28 AI2 max</i> - <i>12.27 AI2 min</i> ).	-
	0.00...100.00%	AI2 value	100 = 1%

No.	Name/Value	Description	Def/FbEq16												
<b>13 Standard AO</b>		Configuration of standard analog outputs.													
13.02	<i>AO force selection</i>	The source signals of the analog outputs can be overridden, for example, for testing purposes. A forced value parameter is provided for each analog output, and its value is applied whenever the corresponding bit in this parameter is 1. <b>Note:</b> Boot and power cycle reset the force selections (parameters <a href="#">13.02</a> and <a href="#">13.11</a> ).	0000h												
<table border="1"> <thead> <tr> <th>Bit</th> <th>Name</th> <th>Value</th> </tr> </thead> <tbody> <tr> <td>0</td> <td>AO1</td> <td>1 = Force AO1 to value of parameter <a href="#">13.13 AO1 forced value</a>. (0 = Normal mode)</td> </tr> <tr> <td>1</td> <td>AO2</td> <td>1 = Force AO2 to value of parameter <a href="#">13.23 AO2 forced value</a>. (0 = Normal mode)</td> </tr> <tr> <td>2...15</td> <td colspan="2">Reserved</td> </tr> </tbody> </table>				Bit	Name	Value	0	AO1	1 = Force AO1 to value of parameter <a href="#">13.13 AO1 forced value</a> . (0 = Normal mode)	1	AO2	1 = Force AO2 to value of parameter <a href="#">13.23 AO2 forced value</a> . (0 = Normal mode)	2...15	Reserved	
Bit	Name	Value													
0	AO1	1 = Force AO1 to value of parameter <a href="#">13.13 AO1 forced value</a> . (0 = Normal mode)													
1	AO2	1 = Force AO2 to value of parameter <a href="#">13.23 AO2 forced value</a> . (0 = Normal mode)													
2...15	Reserved														
	0000h...FFFFh	Forced values selector for analog outputs AO1 and AO2.	1 = 1												
13.11	<i>AO1 actual value</i>	Displays the value of AO1 in mA or V (depending on whether the input is set to current or voltage with parameter <a href="#">13.15 AO1 unit selection</a> ). This parameter is read-only.	-												
	0.000...22.000 mA / 0.000...11.000 V	Value of AO1.	1 = 1 mA												
13.12	<i>AO1 source</i>	Selects a signal to be connected to analog output AO1. Alternatively, sets the output to excitation mode to feed a constant current to a temperature sensor.	<i>Output frequency</i>												
	Zero	None.	0												
	Motor speed used	<a href="#">01.01 Motor speed used</a> (page 199).	1												
	Reserved		2												
	Output frequency	<a href="#">01.06 Output frequency</a> (page 199).	3												
	Motor current	<a href="#">01.07 Motor current</a> (page 199).	4												
	Motor current % of motor nominal	<a href="#">01.08 Motor current % of motor nom</a> (page 199).	5												
	Motor torque	<a href="#">01.10 Motor torque</a> (page 199).	6												
	DC voltage	<a href="#">01.11 DC voltage</a> (page 199).	7												
	Output power	<a href="#">01.14 Output power</a> (page 200).	8												
	Reserved		9												
	Speed ref ramp in	<a href="#">23.01 Speed ref ramp input</a> (page 276).	10												
	Speed ref ramp out	<a href="#">23.02 Speed ref ramp output</a> (page 276).	11												
	Speed ref used	<a href="#">24.01 Used speed reference</a> (page 280).	12												
	Reserved		13												
	Freq ref used	<a href="#">28.02 Frequency ref ramp output</a> (page 291).	14												
	Reserved		15												
	Process PID out	<a href="#">40.01 Process PID output actual</a> (page 353).	16												
	Reserved		17...19												
	Temp sensor 1 excitation	The output is used to feed an excitation current to the temperature sensor 1, see parameter <a href="#">35.11 Temperature 1 source</a> . See also section <a href="#">Motor thermal protection</a> (page 177).	20												

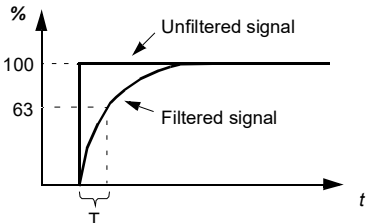
No.	Name/Value	Description	Def/FbEq16
	Temp sensor 2 excitation	The output is used to feed an excitation current to the temperature sensor 2, see parameter <a href="#">35.21 Temperature 2 source</a> . See also section <a href="#">Motor thermal protection</a> (page 177).	21
	Reserved		21...25
	Abs motor speed used	<a href="#">01.61 Abs motor speed used</a> (page 201).	26
	Abs motor speed %	<a href="#">01.62 Abs motor speed %</a> (page 202).	27
	Abs output frequency	<a href="#">01.63 Abs output frequency</a> (page 202).	28
	Reserved		29
	Abs motor torque	<a href="#">01.64 Abs motor torque</a> (page 202).	30
	Abs output power	<a href="#">01.65 Abs output power</a> (page 202).	31
	Abs motor shaft power	<a href="#">01.68 Abs motor shaft power</a> (page 202).	32
	External PID1 out	<a href="#">71.01 External PID act value</a> ((page 400).	33
	Reserved		34...36
	AO1 data storage	<a href="#">13.91 AO1 data storage</a> (page 236).	37
	AO2 data storage	<a href="#">13.92 AO2 data storage</a> (page 236).	38
	<i>Other</i>	Source selection (see <a href="#">Terms and abbreviations</a> on page 196).	-
<a href="#">13.13</a>	<a href="#">AO1 forced value</a>	Forced value that can be used instead of the selected output signal. See parameter <a href="#">13.02 AO force selection</a> .	0.000 mA
	0.000...22.000 mA / 0.000...11.000 V	Forced value for AO1.	1 = 1 unit
<a href="#">13.15</a>	<a href="#">AO1 unit selection</a>	Selects the unit for readings and settings related to analog input AO1.	<i>mA</i>
	V	Volts.	2
	mA	Milliamperes.	10
<a href="#">13.16</a>	<a href="#">AO1 filter time</a>	Defines the filtering time constant for analog output AO1.   $O = I \times (1 - e^{-t/T})$ I = filter input (step) O = filter output t = time T = filter time constant	0.100 s
	0.000 ... 30.000 s	Filter time constant.	1000 = 1 s

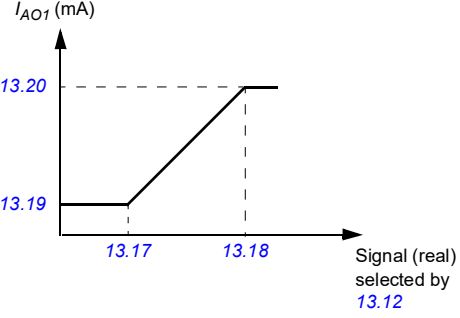
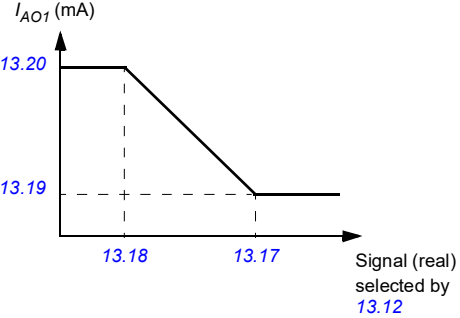

No.	Name/Value	Description	Def/FbEq16
13.17	<i>AO1 source min</i>	<p data-bbox="395 172 904 260">Defines the real minimum value of the signal (selected by parameter <a href="#">13.12 AO1 source</a>) that corresponds to the minimum required AO1 output value (defined by parameter <a href="#">13.19 AO1 out at AO1 src min</a>).</p> <div data-bbox="412 292 871 611">  <p data-bbox="412 292 871 611">The graph plots <math>I_{AO1}</math> (mA) on the vertical axis against the Signal (real) selected by 13.12 on the horizontal axis. The vertical axis has tick marks at 13.19 and 13.20. The horizontal axis has tick marks at 13.17 and 13.18. The signal starts at a low value, remains constant at 13.19 mA until it reaches 13.17. From 13.17 to 13.18, the signal increases linearly, reaching 13.20 mA. For signal values greater than 13.18, the output remains constant at 13.20 mA.</p> </div> <p data-bbox="395 639 904 683">Programming <a href="#">13.17</a> as the maximum value and <a href="#">13.18</a> as the minimum value inverts the output.</p> <div data-bbox="412 715 871 1034">  <p data-bbox="412 715 871 1034">The graph plots <math>I_{AO1}</math> (mA) on the vertical axis against the Signal (real) selected by 13.12 on the horizontal axis. The vertical axis has tick marks at 13.19 and 13.20. The horizontal axis has tick marks at 13.18 and 13.17. The signal starts at a low value, remains constant at 13.20 mA until it reaches 13.18. From 13.18 to 13.17, the signal decreases linearly, reaching 13.19 mA. For signal values greater than 13.17, the output remains constant at 13.19 mA.</p> </div>	0.0

## 234 Parameters

No.	Name/Value	Description	Def/FbEq16
<p>AO has automatic scaling. Every time the source for the AO is changed, the scaling range is changed accordingly. User given minimum and maximum values override the automatic values.</p>			
	<a href="#">13.12 AO1 source</a> , <a href="#">13.22 AO2 source</a>	<a href="#">13.17 AO1 source min</a> , <a href="#">13.27 AO2 source min</a>	<a href="#">13.18 AO1 source max</a> , <a href="#">13.28 AO2 source max</a>
0	<a href="#">Zero</a>	N/A (Output is constant zero.)	
1	<a href="#">Motor speed used</a>	0	<a href="#">46.01 Speed scaling</a>
3	<a href="#">Output frequency</a>	0	<a href="#">46.02 Frequency scaling</a>
4	<a href="#">Motor current</a>	0	Max. value of <a href="#">30.17 Maximum current</a>
5	<a href="#">Motor current % of motor nominal</a>	0%	100%
6	<a href="#">Motor torque</a>	0	<a href="#">46.03 Torque scaling</a>
7	<a href="#">DC voltage</a>	Min. value of <a href="#">01.11 DC voltage</a>	Max. value of <a href="#">01.11 DC voltage</a>
8	<a href="#">Output power</a>	0	<a href="#">46.04 Power scaling</a>
10	<a href="#">Speed ref ramp in</a>	0	<a href="#">46.01 Speed scaling</a>
11	<a href="#">Speed ref ramp out</a>	0	<a href="#">46.01 Speed scaling</a>
12	<a href="#">Speed ref used</a>	0	<a href="#">46.01 Speed scaling</a>
14	<a href="#">Freq ref used</a>	0	<a href="#">46.02 Frequency scaling</a>
16	<a href="#">Process PID out</a>	Min. value of <a href="#">40.01 Process PID output actual</a>	Max. value of <a href="#">40.01 Process PID output actual</a>
20	<a href="#">Temp sensor 1 excitation</a>	N/A (Analog output is not scaled; it is determined by the sensor's triggering voltage.)	
21	<a href="#">Temp sensor 2 excitation</a>		
26	<a href="#">Abs motor speed used</a>	0	<a href="#">46.01 Speed scaling</a>
27	<a href="#">Abs motor speed %</a>	0	<a href="#">46.01 Speed scaling</a>
28	<a href="#">Abs output frequency</a>	0	<a href="#">46.02 Frequency scaling</a>
30	<a href="#">Abs motor torque</a>	0	<a href="#">46.03 Torque scaling</a>
31	<a href="#">Abs output power</a>	0	<a href="#">46.04 Power scaling</a>
32	<a href="#">Abs motor shaft power</a>	0	<a href="#">46.04 Power scaling</a>
33	<a href="#">External PID1 out</a>	Min. value of <a href="#">71.01 External PID act value</a>	Max. value of <a href="#">71.01 External PID act value</a>
	<a href="#">Other</a>	Min. value of the selected parameter	Max. value of the selected parameter
	-32768.0...32767.0	Real signal value corresponding to minimum AO1 output value.	1 = 1
<a href="#">13.18</a>	<a href="#">AO1 source max</a>	Defines the real maximum value of the signal (selected by parameter <a href="#">13.12 AO1 source</a> ) that corresponds to the maximum required AO1 output value (defined by parameter <a href="#">13.20 AO1 out at AO1 src max</a> ). See parameter <a href="#">13.17 AO1 source min</a> .	50.0; 60.0 ( <a href="#">95.20</a> b0)
	-32768.0...32767.0	Real signal value corresponding to maximum AO1 output value.	1 = 1
<a href="#">13.19</a>	<a href="#">AO1 out at AO1 src min</a>	Defines the minimum output value for analog output AO1. See also drawing at parameter <a href="#">13.17 AO1 source min</a> .	0.000 mA
	0.000...22.000 mA/ 0.000...11.000 V	Minimum AO1 output value.	1000 = 1 unit
<a href="#">13.20</a>	<a href="#">AO1 out at AO1 src max</a>	Defines the maximum output value for analog output AO1. See also drawing at parameter <a href="#">13.17 AO1 source min</a> .	20.000 mA
	0.000...22.000 mA/ 0.000...11.000 V	Maximum AO1 output value.	1000 = 1 unit

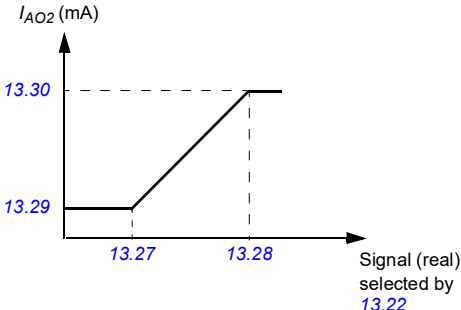
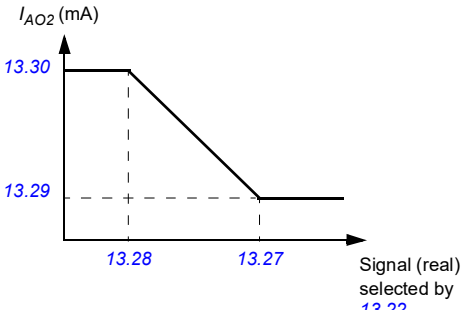
No.	Name/Value	Description	Def/FbEq16
13.21	<i>AO2 actual value</i>	Displays the value of AO2 in mA. This parameter is read-only.	-
	0.000 ... 22.000 mA	Value of AO2.	1000 = 1 mA
13.22	<i>AO2 source</i>	Selects a signal to be connected to analog output AO2. Alternatively, sets the output to excitation mode to feed a constant current to a temperature sensor. For the selections, see parameter <a href="#">13.12 AO1 source</a> .	<i>Motor current</i>
13.23	<i>AO2 forced value</i>	Forced value that can be used instead of the selected output signal. See parameter <a href="#">13.02 AO force selection</a> .	0.000 mA
	0.000 ... 22.000 mA	Forced value for AO2.	1000 = 1 mA
13.26	<i>AO2 filter time</i>	Defines the filtering time constant for analog output AO2. See parameter <a href="#">13.16 AO1 filter time</a> .	0.100 s
	0.000 ... 30.000 s	Filter time constant.	1000 = 1 s
13.27	<i>AO2 source min</i>	Defines the real minimum value of the signal (selected by parameter <a href="#">13.22 AO2 source</a> ) that corresponds to the minimum required AO2 output value (defined by parameter <a href="#">13.29 AO2 out at AO2 src min</a> ). See parameter <a href="#">13.17 AO1 source min</a> about the AO automatic scaling.	0.0
		 <p>Programming <a href="#">13.27</a> as the maximum value and <a href="#">13.28</a> as the minimum value inverts the output.</p> 	
	-32768.0...32767.0	Real signal value corresponding to minimum AO2 output value.	1 = 1

No.	Name/Value	Description	Def/FbEq16
13.28	<i>AO2 source max</i>	Defines the real maximum value of the signal (selected by parameter <a href="#">13.22 AO2 source</a> ) that corresponds to the maximum required AO2 output value (defined by parameter <a href="#">13.30 AO2 out at AO2 src max</a> ). See parameter <a href="#">13.27 AO2 source min</a> . See parameter <a href="#">13.17 AO1 source min</a> about the AO automatic scaling.	2.2
	-32768.0...32767.0	Real signal value corresponding to maximum AO2 output value.	1 = 1
13.29	<i>AO2 out at AO2 src min</i>	Defines the minimum output value for analog output AO2. See also drawing at parameter <a href="#">13.27 AO2 source min</a> .	4.000 mA
	0.000 ... 22.000 mA	Minimum AO2 output value.	1000 = 1 mA
13.30	<i>AO2 out at AO2 src max</i>	Defines the maximum output value for analog output AO2. See also drawing at parameter <a href="#">13.27 AO2 source min</a> .	20.000 mA
	0.000 ... 22.000 mA	Maximum AO2 output value.	1000 = 1 mA
13.91	<i>AO1 data storage</i>	Storage parameter for controlling analog output AO1, for example, through the embedded fieldbus interface. In parameter <a href="#">13.12 AO1 source</a> , select <a href="#">AO1 data storage</a> . Then set this parameter as the target of the incoming value data. With the embedded fieldbus interface, simply set the target selection parameter of that particular data ( <a href="#">58.101...58.114</a> ) to <a href="#">AO1 data storage</a> .	0.00
	-327.68...327.67	Storage parameter for AO1.	100 = 1
13.92	<i>AO2 data storage</i>	Storage parameter for controlling analog output AO2, for example, through the embedded fieldbus interface. In parameter <a href="#">13.22 AO2 source</a> , select <a href="#">AO2 data storage</a> . Then set this parameter as the target of the incoming value data. With the embedded fieldbus interface, simply set the target selection parameter of that particular data ( <a href="#">58.101...58.114</a> ) to <a href="#">AO2 data storage</a> .	0.00
	-327.68...327.67	Storage parameter for AO2.	100 = 1
<b>15 I/O extension module</b>		Configuration of the I/O extension module installed in slot 2. See also section <a href="#">Programmable I/O extensions</a> (page 122). <b>Note:</b> The contents of the parameter group vary according to the selected I/O extension module type.	
15.01	<i>Extension module type</i>	Activates (and specifies the type of) I/O extension module. If the value is <i>None</i> , when an extension module has been installed and the drive is powered, the drive automatically sets the value to the type it has detected (= value of parameter <a href="#">15.02 Detected extension module</a> ); otherwise warning <a href="#">A7AB Extension I/O configuration failure</a> is generated and you have to set the value of this parameter manually.	<i>None</i>
	None	Inactive.	0
	CMOD-01	CMOD-01 multifunction extension module (external 24 V AC/DC and digital I/O).	1
	CMOD-02	CMOD-02 multifunction extension module (external 24 V AC/DC and isolated PTC interface).	2
	CHDI-01	CHDI-01 115/230 V digital input extension module.	3
	CPTC-02	CPTC-02 extension module (external 24 V and ATEX certified PTC interface).	4

No.	Name/Value	Description	Def/FbEq16																								
15.02	<i>Detected extension module</i>	I/O extension module detected on the drive.	<i>None</i>																								
	None	Inactive.	0																								
	CMOD-01	CMOD-01 multifunction extension module (external 24 V AC/DC and digital I/O).	1																								
	CMOD-02	CMOD-02 multifunction extension module (external 24 V AC/DC and isolated PTC interface).	2																								
	CHDI-01	CHDI-01 115/230 V digital input extension module.	3																								
	CPTC-02	CPTC-02 extension module (external 24 V and ATEX certified PTC interface).	4																								
15.03	<i>DI status</i>	Displays the status of the digital inputs DI7...DI12 on the extension module Bit 0 indicates the status of DI7. <b>Example:</b> 001001b = DI7 and DI10 are on, the rest are off. This parameter is read-only.	-																								
		<table border="1"> <thead> <tr> <th>Bit</th> <th>Name</th> <th>Description</th> </tr> </thead> <tbody> <tr> <td>0</td> <td>DI7</td> <td>1 = Digital input 7 is ON.</td> </tr> <tr> <td>1</td> <td>DI8</td> <td>1 = Digital input 8 is ON.</td> </tr> <tr> <td>2</td> <td>DI9</td> <td>1 = Digital input 9 is ON.</td> </tr> <tr> <td>2</td> <td>DI10</td> <td>1 = Digital input 10 is ON.</td> </tr> <tr> <td>4</td> <td>DI11</td> <td>1 = Digital input 11 is ON.</td> </tr> <tr> <td>5</td> <td>DI12</td> <td>1 = Digital input 12 is ON.</td> </tr> <tr> <td>6...15</td> <td>Reserved</td> <td></td> </tr> </tbody> </table>	Bit	Name	Description	0	DI7	1 = Digital input 7 is ON.	1	DI8	1 = Digital input 8 is ON.	2	DI9	1 = Digital input 9 is ON.	2	DI10	1 = Digital input 10 is ON.	4	DI11	1 = Digital input 11 is ON.	5	DI12	1 = Digital input 12 is ON.	6...15	Reserved		
Bit	Name	Description																									
0	DI7	1 = Digital input 7 is ON.																									
1	DI8	1 = Digital input 8 is ON.																									
2	DI9	1 = Digital input 9 is ON.																									
2	DI10	1 = Digital input 10 is ON.																									
4	DI11	1 = Digital input 11 is ON.																									
5	DI12	1 = Digital input 12 is ON.																									
6...15	Reserved																										
	0000h...FFFFh	Status of digital input/outputs.	1 = 1																								
15.04	<i>RO/DO status</i>	Displays the status of the relay outputs RO4 and RO5 and digital output DO1 on the extension module. Bits 0...1 indicates the status of RO4...RO5; bit 5 indicates the status of DO1. <b>Example:</b> 100101b = RO4 is on, RO5 is off. and DO1 is on. This parameter is read-only.	-																								
		<table border="1"> <thead> <tr> <th>Bit</th> <th>Name</th> <th>Description</th> </tr> </thead> <tbody> <tr> <td>0</td> <td>RO4</td> <td>1 = Relay output 4 is ON.</td> </tr> <tr> <td>1</td> <td>RO5</td> <td>1 = Relay output 5 is ON</td> </tr> <tr> <td>2...4</td> <td>Reserved</td> <td></td> </tr> <tr> <td>5</td> <td>DO1</td> <td>1 = Digital output 1 is ON.</td> </tr> <tr> <td>6...15</td> <td>Reserved</td> <td></td> </tr> </tbody> </table>	Bit	Name	Description	0	RO4	1 = Relay output 4 is ON.	1	RO5	1 = Relay output 5 is ON	2...4	Reserved		5	DO1	1 = Digital output 1 is ON.	6...15	Reserved								
Bit	Name	Description																									
0	RO4	1 = Relay output 4 is ON.																									
1	RO5	1 = Relay output 5 is ON																									
2...4	Reserved																										
5	DO1	1 = Digital output 1 is ON.																									
6...15	Reserved																										
	0000h...FFFFh	Status of relay/digital outputs.	1 = 1																								

No.	Name/Value	Description	Def/FbEq16																		
15.05	<i>RO/DO force selection</i>	The electrical statuses of the relay/digital outputs can be overridden, for example, for testing purposes. A bit in parameter <i>15.06 RO/DO forced data</i> is provided for each relay or digital output, and its value is applied whenever the corresponding bit in this parameter is 1. <b>Note:</b> Boot and power cycle reset the force selections (parameters <i>15.05</i> and <i>15.06</i> ).	0000h																		
<table border="1"> <thead> <tr> <th>Bit</th> <th>Name</th> <th>Value</th> </tr> </thead> <tbody> <tr> <td>0</td> <td>RO4</td> <td>1 = Force RO4 to value of bit 0 of parameter <i>15.06 RO/DO forced data</i>.</td> </tr> <tr> <td>1</td> <td>RO5</td> <td>1 = Force RO5 to value of bit 1 of parameter <i>15.06 RO/DO forced data</i>.</td> </tr> <tr> <td>2...4</td> <td colspan="2">Reserved</td> </tr> <tr> <td>5</td> <td>DO1</td> <td>1 = Force DO1 to value of bit 5 of parameter <i>15.06 RO/DO forced data</i>.</td> </tr> <tr> <td>6...15</td> <td colspan="2">Reserved</td> </tr> </tbody> </table>				Bit	Name	Value	0	RO4	1 = Force RO4 to value of bit 0 of parameter <i>15.06 RO/DO forced data</i> .	1	RO5	1 = Force RO5 to value of bit 1 of parameter <i>15.06 RO/DO forced data</i> .	2...4	Reserved		5	DO1	1 = Force DO1 to value of bit 5 of parameter <i>15.06 RO/DO forced data</i> .	6...15	Reserved	
Bit	Name	Value																			
0	RO4	1 = Force RO4 to value of bit 0 of parameter <i>15.06 RO/DO forced data</i> .																			
1	RO5	1 = Force RO5 to value of bit 1 of parameter <i>15.06 RO/DO forced data</i> .																			
2...4	Reserved																				
5	DO1	1 = Force DO1 to value of bit 5 of parameter <i>15.06 RO/DO forced data</i> .																			
6...15	Reserved																				
0000h...FFFFh		Override selection for relay/digital outputs.	1 = 1																		
15.06	<i>RO/DO forced data</i>	Allows the data value of a forced relay or digital output to be changed from 0 to 1. It is only possible to force an output that has been selected in parameter <i>15.05 RO/DO force selection</i> . Bits 0...1 are the forced values for RO4...RO5; bit 5 is the forced value for DO1.	0000h																		
<table border="1"> <thead> <tr> <th>Bit</th> <th>Name</th> <th>Description</th> </tr> </thead> <tbody> <tr> <td>0</td> <td>RO4</td> <td>Force the value of this bit to RO4, if so defined in parameter <i>15.05 RO/DO force selection</i>.</td> </tr> <tr> <td>1</td> <td>RO5</td> <td>Force the value of this bit to RO5, if so defined in parameter <i>15.05 RO/DO force selection</i>.</td> </tr> <tr> <td>2...4</td> <td colspan="2">Reserved</td> </tr> <tr> <td>5</td> <td>DO1</td> <td>Force the value of this bit to DO1 if so defined in parameter <i>15.05 RO/DO force selection</i>.</td> </tr> <tr> <td>6...15</td> <td colspan="2">Reserved</td> </tr> </tbody> </table>				Bit	Name	Description	0	RO4	Force the value of this bit to RO4, if so defined in parameter <i>15.05 RO/DO force selection</i> .	1	RO5	Force the value of this bit to RO5, if so defined in parameter <i>15.05 RO/DO force selection</i> .	2...4	Reserved		5	DO1	Force the value of this bit to DO1 if so defined in parameter <i>15.05 RO/DO force selection</i> .	6...15	Reserved	
Bit	Name	Description																			
0	RO4	Force the value of this bit to RO4, if so defined in parameter <i>15.05 RO/DO force selection</i> .																			
1	RO5	Force the value of this bit to RO5, if so defined in parameter <i>15.05 RO/DO force selection</i> .																			
2...4	Reserved																				
5	DO1	Force the value of this bit to DO1 if so defined in parameter <i>15.05 RO/DO force selection</i> .																			
6...15	Reserved																				
0000h...FFFFh		Forced values of relay/digital outputs.	1 = 1																		
15.07	<i>RO4 source</i>	Selects a drive signal to be connected to relay output RO4.	<i>Not energized</i>																		
Not energized		Output is not energized.	0																		
Energized		Output is energized.	1																		
Ready run		Bit 1 of <i>06.11 Main status word</i> (see page 209).	2																		
Reserved			3																		
Enabled		Bit 0 of <i>06.16 Drive status word 1</i> (see page 210).	4																		
Started		Bit 5 of <i>06.16 Drive status word 1</i> (see page 210).	5																		
Magnetized		Bit 1 of <i>06.17 Drive status word 2</i> (see page 211).	6																		
Running		Bit 6 of <i>06.16 Drive status word 1</i> (see page 210).	7																		
Ready ref		Bit 2 of <i>06.11 Main status word</i> (see page 209).	8																		
At setpoint		Bit 8 of <i>06.11 Main status word</i> (see page 209).	9																		
Reverse		Bit 2 of <i>06.19 Speed control status word</i> (see page 212).	10																		
Zero speed		Bit 0 of <i>06.19 Speed control status word</i> (see page 212).	11																		

No.	Name/Value	Description	Def/FbEq16
	Above limit	Bit 10 of <a href="#">06.17 Drive status word 2</a> (see page <a href="#">211</a> ).	12
	Warning	Bit 7 of <a href="#">06.11 Main status word</a> (see page <a href="#">209</a> ).	13
	Fault	Bit 3 of <a href="#">06.11 Main status word</a> (see page <a href="#">209</a> ).	14
	Fault (-1)	Inverted bit 3 of <a href="#">06.11 Main status word</a> (see page <a href="#">209</a> ).	15
	Fault/Warning	Bit 3 of <a href="#">06.11 Main status word</a> OR bit 7 of <a href="#">06.11 Main status word</a> (see page <a href="#">209</a> ).	16
	Overcurrent	Fault <a href="#">2310 Overcurrent</a> has occurred.	17
	Overvoltage	Fault <a href="#">3210 DC link overvoltage</a> has occurred.	18
	Drive temp	Fault <a href="#">2381 IGBT overload</a> or <a href="#">4110 Control board temperature</a> or <a href="#">4210 IGBT overtemperature</a> or <a href="#">4290 Cooling</a> or <a href="#">42F1 IGBT temperature</a> or <a href="#">4310 Excess temperature</a> or <a href="#">4380 Excess temperature difference</a> has occurred.	19
	Undervoltage	Fault <a href="#">3220 DC link undervoltage</a> has occurred.	20
	Motor temp	Fault <a href="#">4981 External temperature 1</a> or <a href="#">4982 External temperature 2</a> has occurred.	21
	Brake command	Bit 0 of <a href="#">44.01 Brake control status</a> (see page <a href="#">373</a> ).	22
	Ext2 active	Bit 11 of <a href="#">06.16 Drive status word 1</a> (see page <a href="#">210</a> ).	23
	Remote control	Bit 9 of <a href="#">06.11 Main status word</a> (see page <a href="#">209</a> ).	24
	Reserved		25...26
	Timed function 1	Bit 0 of <a href="#">34.01 Timed functions status</a> (see page <a href="#">327</a> ).	27
	Timed function 2	Bit 1 of <a href="#">34.01 Timed functions status</a> (see page <a href="#">327</a> ).	28
	Timed function 3	Bit 2 of <a href="#">34.01 Timed functions status</a> (see page <a href="#">327</a> ).	29
	Reserved		30...32
	Supervision 1	Bit 0 of <a href="#">32.01 Supervision status</a> (see page <a href="#">319</a> ).	33
	Supervision 2	Bit 1 of <a href="#">32.01 Supervision status</a> (see page <a href="#">319</a> ).	34
	Supervision 3	Bit 2 of <a href="#">32.01 Supervision status</a> (see page <a href="#">319</a> ).	35
	Reserved		36...38
	Start delay	Bit 13 of <a href="#">06.17 Drive status word 2</a> (see page <a href="#">211</a> ).	39
	RO/DIO control word bit0	Bit 0 of <a href="#">10.99 RO/DIO control word</a> (see page <a href="#">224</a> ).	40
	RO/DIO control word bit1	Bit 1 of <a href="#">10.99 RO/DIO control word</a> (see page <a href="#">224</a> ).	41
	RO/DIO control word bit2	Bit 2 of <a href="#">10.99 RO/DIO control word</a> (see page <a href="#">224</a> ).	42
	Reserved		43...44
	PFC1	Bit 0 of <a href="#">76.01 PFC status</a> (see page <a href="#">403</a> ).	45
	PFC2	Bit 1 of <a href="#">76.01 PFC status</a> (see page <a href="#">403</a> ).	46
	PFC3	Bit 2 of <a href="#">76.01 PFC status</a> (see page <a href="#">403</a> ).	47
	PFC4	Bit 3 of <a href="#">76.01 PFC status</a> (see page <a href="#">403</a> ).	48
	PFC5	Bit 4 of <a href="#">76.01 PFC status</a> (see page <a href="#">403</a> ).	49
	PFC6	Bit 5 of <a href="#">76.01 PFC status</a> (see page <a href="#">403</a> ).	50
	Reserved		51...52

No.	Name/Value	Description	Def/FbEq16
	Event word 1	Event word 1 = 1 if any bit of <a href="#">04.40 Event word 1</a> (see page <a href="#">204</a> ) is 1, that is, if any warning, fault or pure event that has been defined with parameters <a href="#">04.41...04.71</a> is on.	53
	User load curve	Bit 3 (Outside load limit) of <a href="#">37.01 ULC output status word</a> (see page <a href="#">349</a> ).	61
	RO/DIO control word	<a href="#">For 15.07 RO4 source</a> : Bit 3 (RO4) of <a href="#">10.99 RO/DIO control word</a> (see page <a href="#">224</a> ). <a href="#">For 15.10 RO5 source</a> : Bit 4 (RO5) of <a href="#">10.99 RO/DIO control word</a> (see page <a href="#">224</a> ).	62
	<i>Other [bit]</i>	Source selection (see <a href="#">Terms and abbreviations</a> on page <a href="#">196</a> ).	-
<a href="#">15.08</a>	<a href="#">RO4 ON delay</a>	Defines the activation delay for relay output RO4.	0.0 s
<p><math>t_{On} = 15.08</math> RO4 ON delay <math>t_{Off} = 15.09</math> RO4 OFF delay</p>			
	0.0 ... 3000.0 s	Activation delay for RO4.	10 = 1 s
<a href="#">15.09</a>	<a href="#">RO4 OFF delay</a>	Defines the deactivation delay for relay output RO4. See parameter <a href="#">15.08 RO4 ON delay</a> .	0.0 s
	0.0 ... 3000.0 s	Deactivation delay for RO4.	10 = 1 s
<a href="#">15.10</a>	<a href="#">RO5 source</a>	Selects a drive signal to be connected to relay output RO5. For the available selections, see parameter <a href="#">15.07 RO4 source</a> .	<i>Not energized</i>
<a href="#">15.11</a>	<a href="#">RO5 ON delay</a>	Defines the activation delay for relay output RO5.	0.0 s
<p><math>t_{On} = 15.11</math> RO5 ON delay <math>t_{Off} = 15.12</math> RO5 OFF delay</p>			
	0.0 ... 3000.0 s	Activation delay for RO5.	10 = 1 s
<a href="#">15.12</a>	<a href="#">RO5 OFF delay</a>	Defines the deactivation delay for relay output RO5. See parameter <a href="#">15.11 RO5 ON delay</a> .	0.0 s
	0.0 ... 3000.0 s	Deactivation delay for RO5.	10 = 1 s
<a href="#">15.22</a>	<a href="#">DO1 configuration</a>	Selects how DO1 is used.	<i>Digital output</i>
	Digital output	DO1 is used as a digital output.	0



No.	Name/Value	Description	Def/FbEq16
	Frequency output	DO1 is used as a frequency output.	2
15.23	<i>DO1 source</i>	Selects a drive signal to be connected to digital output DO1 when <i>15.22 DO1 configuration</i> is set to <i>Digital output</i> .	<i>Not energized</i>
	Not energized	Output is not energized.	0
	Energized	Output is energized.	1
	Ready run	Bit 1 of <i>06.11 Main status word</i> (see page 209).	2
	Reserved		3
	Enabled	Bit 0 of <i>06.16 Drive status word 1</i> (see page 210).	4
	Started	Bit 5 of <i>06.16 Drive status word 1</i> (see page 210).	5
	Magnetized	Bit 1 of <i>06.17 Drive status word 2</i> (see page 211).	6
	Running	Bit 6 of <i>06.16 Drive status word 1</i> (see page 210).	7
	Ready ref	Bit 2 of <i>06.11 Main status word</i> (see page 209).	8
	At setpoint	Bit 8 of <i>06.11 Main status word</i> (see page 209).	9
	Reverse	Bit 2 of <i>06.19 Speed control status word</i> (see page 212).	10
	Zero speed	Bit 0 of <i>06.19 Speed control status word</i> (see page 212).	11
	Above limit	Bit 10 of <i>06.17 Drive status word 2</i> (see page 211).	12
	Warning	Bit 7 of <i>06.11 Main status word</i> (see page 209).	13
	Fault	Bit 3 of <i>06.11 Main status word</i> (see page 209).	14
	Fault (-1)	Inverted bit 3 of <i>06.11 Main status word</i> (see page 209).	15
	Fault/Warning	Bit 3 of <i>06.11 Main status word</i> OR bit 7 of <i>06.11 Main status word</i> (see page 209).	16
	Overcurrent	Fault <i>2310 Overcurrent</i> has occurred.	17
	Overvoltage	Fault <i>3210 DC link overvoltage</i> has occurred.	18
	Drive temp	Fault <i>2381 IGBT overload</i> or <i>4110 Control board temperature</i> or <i>4210 IGBT overtemperature</i> or <i>4290 Cooling</i> or <i>42F1 IGBT temperature</i> or <i>4310 Excess temperature</i> or <i>4380 Excess temperature difference</i> has occurred.	19
	Undervoltage	Fault <i>3220 DC link undervoltage</i> has occurred.	20
	Motor temp	Fault <i>4981 External temperature 1</i> or <i>4982 External temperature 2</i> has occurred.	21
	Brake command	Bit 0 of <i>44.01 Brake control status</i> (see page 373).	22
	Ext2 active	Bit 11 of <i>06.16 Drive status word 1</i> (see page 210).	23
	Remote control	Bit 9 of <i>06.11 Main status word</i> (see page 209).	24
	Reserved		25...26
	Timed function 1	Bit 0 of <i>34.01 Timed functions status</i> (see page 327).	27
	Timed function 2	Bit 1 of <i>34.01 Timed functions status</i> (see page 327).	28
	Timed function 3	Bit 2 of <i>34.01 Timed functions status</i> (see page 327).	29
	Reserved		30...32
	Supervision 1	Bit 0 of <i>32.01 Supervision status</i> (see page 319).	33
	Supervision 2	Bit 1 of <i>32.01 Supervision status</i> (see page 319).	34
	Supervision 3	Bit 2 of <i>32.01 Supervision status</i> (see page 319).	35
	Reserved		36...38
	Start delay	Bit 13 of <i>06.17 Drive status word 2</i> (see page 211).	39

No.	Name/Value	Description	Def/FbEq16
	RO/DIO control word bit0	Bit 0 of <a href="#">10.99 RO/DIO control word</a> (see page <a href="#">224</a> ).	40
	RO/DIO control word bit1	Bit 1 of <a href="#">10.99 RO/DIO control word</a> (see page <a href="#">224</a> ).	41
	RO/DIO control word bit2	Bit 2 of <a href="#">10.99 RO/DIO control word</a> (see page <a href="#">224</a> ).	42
	Reserved	<b>Hint:</b> To access bits 3, 4, and 8 of <a href="#">10.99 RO/DIO control word</a> (see page <a href="#">224</a> ), use selection 53 ( <a href="#">Other [bit]</a> ).	43...44
	PFC1	Bit 0 of <a href="#">76.01 PFC status</a> (see page <a href="#">403</a> ).	45
	PFC2	Bit 1 of <a href="#">76.01 PFC status</a> (see page <a href="#">403</a> ).	46
	PFC3	Bit 2 of <a href="#">76.01 PFC status</a> (see page <a href="#">403</a> ).	47
	PFC4	Bit 3 of <a href="#">76.01 PFC status</a> (see page <a href="#">403</a> ).	48
	PFC5	Bit 4 of <a href="#">76.01 PFC status</a> (see page <a href="#">403</a> ).	49
	PFC6	Bit 5 of <a href="#">76.01 PFC status</a> (see page <a href="#">403</a> ).	50
	Reserved		51...52
	Event word 1	Event word 1 = 1 if any bit of <a href="#">04.40 Event word 1</a> (see page <a href="#">204</a> ) is 1, that is, if any warning, fault or pure event that has been defined with parameters <a href="#">04.41...04.71</a> is on.	53
	User load curve	Bit 3 (Outside load limit) of <a href="#">37.01 ULC output status word</a> (see page <a href="#">349</a> ).	61
	RO/DIO control word	For <a href="#">15.23 DO1 source</a> : Bit 8 (DIO1) of <a href="#">10.99 RO/DIO control word</a> (see page <a href="#">224</a> ).	62
	<a href="#">Other [bit]</a>	Source selection (see <a href="#">Terms and abbreviations</a> on page <a href="#">196</a> ).	-
<a href="#">15.24</a>	<a href="#">DO1 ON delay</a>	Defines the activation delay for digital output DO1 when <a href="#">15.22 DO1 configuration</a> is set to <a href="#">Digital output</a> .	0.0 s
	<p> <math>t_{on} = \text{15.24 DO1 ON delay}</math>  <math>t_{off} = \text{15.25 DO1 OFF delay}</math> </p>		
	0.0 ... 3000.0 s	Activation delay for DO1.	10 = 1 s
<a href="#">15.25</a>	<a href="#">DO1 OFF delay</a>	Defines the deactivation delay for relay output DO1 when <a href="#">15.22 DO1 configuration</a> is set to <a href="#">Digital output</a> . See parameter <a href="#">15.24 DO1 ON delay</a> .	0.0 s
	0.0 ... 3000.0 s	Deactivation delay for DO1.	10 = 1 s
<a href="#">15.32</a>	<a href="#">Freq out 1 actual value</a>	Displays the value of frequency output 1 at digital output DO1 when <a href="#">15.22 DO1 configuration</a> is set to <a href="#">Frequency output</a> . This parameter is read-only.	-
	0 ... 16000 Hz	Value of frequency output 1.	1 = 1 Hz

No.	Name/Value	Description	Def/FbEq16
15.33	<i>Freq out 1 source</i>	Selects a signal to be connected to digital output DO1 when <a href="#">15.22 DO1 configuration</a> is set to <i>Frequency output</i> . Alternatively, sets the output to excitation mode to feed a constant current to a temperature sensor.	<i>Motor speed used</i>
	Not selected	None.	0
	Motor speed used	<a href="#">01.01 Motor speed used</a> (page 199).	1
	Output frequency	<a href="#">01.06 Output frequency</a> (page 199).	3
	Motor current	<a href="#">01.07 Motor current</a> (page 199).	4
	Motor torque	<a href="#">01.10 Motor torque</a> (page 199).	6
	DC voltage	<a href="#">01.11 DC voltage</a> (page 199).	7
	Output power	<a href="#">01.14 Output power</a> (page 200).	8
	Speed ref ramp in	<a href="#">23.01 Speed ref ramp input</a> (page 276).	10
	Speed ref ramp out	<a href="#">23.02 Speed ref ramp output</a> (page 276).	11
	Speed ref used	<a href="#">24.01 Used speed reference</a> (page 280).	12
	Torque ref used	<a href="#">26.02 Torque reference used</a> (page 286).	13
	Freq ref used	<a href="#">28.02 Frequency ref ramp output</a> (page 291).	14
	Reserved		15
	Process PID out	<a href="#">40.01 Process PID output actual</a> (page 353).	16
	<i>Other</i>	Source selection (see <a href="#">Terms and abbreviations</a> on page 196).	-

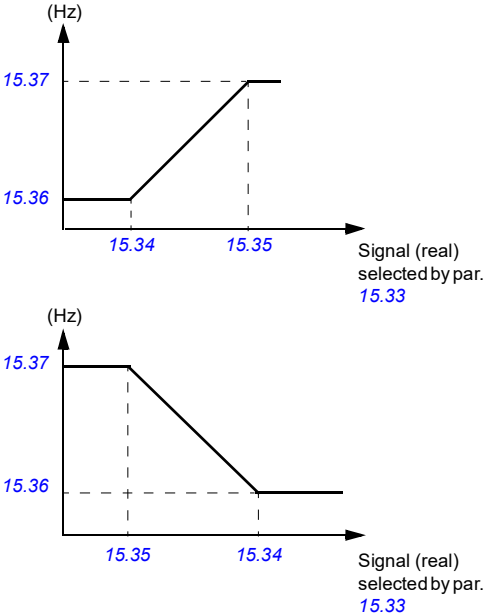
No.	Name/Value	Description	Def/FbEq16
15.34	<i>Freq out 1 src min</i>	<p>Defines the real value of the signal (selected by parameter <a href="#">15.33 Freq out 1 source</a>) that corresponds to the minimum value of frequency output 1 (defined by parameter <a href="#">15.36 Freq out 1 at src min</a>). This applies when <a href="#">15.22 DO1 configuration</a> is set to <i>Frequency output</i>.</p> 	0.000
	-32768.000... 32767.000	Real signal value corresponding to minimum value of frequency output 1.	1 = 1
15.35	<i>Freq out 1 src max</i>	<p>Defines the real value of the signal (selected by parameter <a href="#">15.33 Freq out 1 source</a>) that corresponds to the maximum value of frequency output 1 (defined by parameter <a href="#">15.37 Freq out 1 at src max</a>). This applies when <a href="#">15.22 DO1 configuration</a> is set to <i>Frequency output</i>. See parameter <a href="#">15.34 Freq out 1 src min</a>.</p>	1500.000; 1800.000 ( <a href="#">95.20 b0</a> )
	-32768.000... 32767.000	Real signal value corresponding to maximum value of frequency output 1.	1 = 1
15.36	<i>Freq out 1 at src min</i>	<p>Defines the minimum output value of frequency output 1 when <a href="#">15.22 DO1 configuration</a> is set to <i>Frequency output</i>. See also drawing at parameter <a href="#">15.34 Freq out 1 src min</a>.</p>	0 Hz
	0 ... 16000 Hz	Minimum frequency output 1 value.	1 = 1 Hz
15.37	<i>Freq out 1 at src max</i>	<p>Defines the maximum value of frequency output 1 when <a href="#">15.22 DO1 configuration</a> is set to <i>Frequency output</i>. See also drawing at parameter <a href="#">15.34 Freq out 1 src min</a>.</p>	16000 Hz
	0 ... 16000 Hz	Maximum value of frequency output 1.	1 = 1 Hz

No.	Name/Value	Description	Def/FbEq16
<b>19 Operation mode</b>			
		Selection of local and external control location sources and operating modes. See also section <i>Operating modes of the drive</i> (page 112).	
19.01	<i>Actual operation mode</i>	Displays the operating mode currently used. See parameters 19.11...19.14. This parameter is read-only.	<i>Scalar (Hz)</i>
	Zero	None.	1
	Speed	Speed control (in vector motor control mode).	2
	Torque	Torque control (in vector motor control mode).	3
	Min	The torque selector is comparing the output of the speed controller (25.01 <i>Torque reference speed control</i> ) and torque reference (26.74 <i>Torque ref ramp out</i> ) and the smaller of the two is used (in vector motor control mode).	4
	Max	The torque selector is comparing the output of the speed controller (25.01 <i>Torque reference speed control</i> ) and torque reference (26.74 <i>Torque ref ramp out</i> ) and the greater of the two is used (in vector motor control mode).	5
	Add	The speed controller output is added to the torque reference (in vector motor control mode).	6
	Reserved		7...9
	Scalar (Hz)	Frequency control in scalar motor control mode.	10
	Forced magn.	Motor is in magnetizing mode.	20
19.11	<i>Ext1/Ext2 selection</i>	Selects the source for external control location EXT1/EXT2 selection. 0 = EXT1 1 = EXT2	<i>EXT1</i>
	EXT1	EXT1 (permanently selected).	0
	EXT2	EXT2 (permanently selected).	1
	FBA A MCW bit 11	Control word bit 11 received through fieldbus interface A.	2
	DI1	Digital input DI1 (10.02 <i>DI delayed status</i> , bit 0).	3
	DI2	Digital input DI2 (10.02 <i>DI delayed status</i> , bit 1).	4
	DI3	Digital input DI3 (10.02 <i>DI delayed status</i> , bit 2).	5
	DI4	Digital input DI4 (10.02 <i>DI delayed status</i> , bit 3).	6
	DI5	Digital input DI5 (10.02 <i>DI delayed status</i> , bit 4).	7
	DI6	Digital input DI6 (10.02 <i>DI delayed status</i> , bit 5).	8
	Reserved		9...18
	Timed function 1	Bit 0 of 34.01 <i>Timed functions status</i> (see page 327).	19
	Timed function 2	Bit 1 of 34.01 <i>Timed functions status</i> (see page 327).	20
	Timed function 3	Bit 2 of 34.01 <i>Timed functions status</i> (see page 327).	21
	Reserved		22...24
	Supervision 1	Bit 0 of 32.01 <i>Supervision status</i> (see page 319).	25
	Supervision 2	Bit 1 of 32.01 <i>Supervision status</i> (see page 319).	26
	Supervision 3	Bit 2 of 32.01 <i>Supervision status</i> (see page 319).	27
	Reserved		28...31

No.	Name/Value	Description	Def/FbEq16
	EFB MCW bit 11	Control word bit 11 received through the embedded fieldbus interface.	32
	FBA A connection loss	Detected communication loss of fieldbus interface A changes control mode to EXT2.	33
	EFB connection loss	Detected communication loss of embedded fieldbus interface changes control mode to EXT2.	34
	<i>Other [bit]</i>	Source selection (see <i>Terms and abbreviations</i> on page 196).	-
19.12	<i>Ext1 control mode</i>	Selects the operating mode for external control location EXT1 in vector motor control mode.	<i>Speed</i>
	Zero	None.	1
	Speed	Speed control. The torque reference used is <i>25.01 Torque reference speed control</i> (output of the speed reference chain).	2
	Torque	Torque control. The torque reference used is <i>26.74 Torque ref ramp out</i> (output of the torque reference chain).	3
	Minimum	Combination of selections <i>Speed</i> and <i>Torque</i> : the torque selector compares the speed controller output ( <i>25.01 Torque reference speed control</i> ) and the torque reference ( <i>26.74 Torque ref ramp out</i> ) and selects the smaller of the two. If speed error becomes negative, the drive follows the speed controller output until speed error becomes positive again. This prevents the drive from accelerating uncontrollably if the load is lost in torque control.	4
	Maximum	Combination of selections <i>Speed</i> and <i>Torque</i> : the torque selector compares the speed controller output ( <i>25.01 Torque reference speed control</i> ) and the torque reference ( <i>26.74 Torque ref ramp out</i> ) and selects the greater of the two. If speed error becomes positive, the drive follows the speed controller output until speed error becomes negative again. This prevents the drive from accelerating uncontrollably if the load is lost in torque control.	5
19.14	<i>Ext2 control mode</i>	Selects the operating mode for external control location EXT2 in vector motor control mode. For the selections, see parameter <i>19.12 Ext1 control mode</i> .	<i>Speed</i>
19.16	<i>Local control mode</i>	Selects the operating mode for local control in vector motor control mode.	<i>Speed</i>
	Speed	Speed control. The torque reference used is <i>25.01 Torque reference speed control</i> (output of the speed reference chain).	0
	Torque	Torque control. The torque reference used is <i>26.74 Torque ref ramp out</i> (output of the torque reference chain).	1
19.17	<i>Local control disable</i>	Enables/disables local control (start and stop buttons on the control panel, and the local controls on the PC tool).  <b>WARNING!</b> Before disabling local control, ensure that the control panel is not needed for stopping the drive.	<i>No</i>
	No	Local control enabled.	0
	Yes	Local control disabled.	1

No.	Name/Value	Description	Def/FbEq16															
	<b>20 Start/stop/direction</b>	Start/stop/direction and run/start/jog enable signal source selection; positive/negative reference enable signal source selection. For information on control locations, see section <a href="#">Local control vs. external control</a> (page 107).																
20.01	<i>Ext1 commands</i>	Selects the source of start, stop and direction commands for external control location 1 (EXT1). See parameter 20.21 for the determination of the actual direction. See also parameters 20.02...20.05.	<i>In1 Start; In2 Dir</i>															
	Not selected	No start or stop command sources selected.	0															
	In1 Start	The source of the start and stop commands is selected by parameter 20.03 <i>Ext1 in1 source</i> . The state transitions of the source bits are interpreted as follows: <table border="1" data-bbox="396 523 743 628"> <thead> <tr> <th>State of source 1 (20.03)</th> <th>Command</th> </tr> </thead> <tbody> <tr> <td>0 -&gt; 1 (20.02 = Edge) 1 (20.02 = Level)</td> <td>Start</td> </tr> <tr> <td>0</td> <td>Stop</td> </tr> </tbody> </table>	State of source 1 (20.03)	Command	0 -> 1 (20.02 = Edge) 1 (20.02 = Level)	Start	0	Stop	1									
State of source 1 (20.03)	Command																	
0 -> 1 (20.02 = Edge) 1 (20.02 = Level)	Start																	
0	Stop																	
	In1 Start; In2 Dir	The source selected by 20.03 <i>Ext1 in1 source</i> is the start signal; the source selected by 20.04 <i>Ext1 in2 source</i> determines the direction. The state transitions of the source bits are interpreted as follows: <table border="1" data-bbox="396 756 902 884"> <thead> <tr> <th>State of source 1 (20.03)</th> <th>State of source 2 (20.04)</th> <th>Command</th> </tr> </thead> <tbody> <tr> <td>0</td> <td>Any</td> <td>Stop</td> </tr> <tr> <td>0 -&gt; 1 (20.02 = Edge)</td> <td>0</td> <td>Start forward</td> </tr> <tr> <td>1 (20.02 = Level)</td> <td>1</td> <td>Start reverse</td> </tr> </tbody> </table>	State of source 1 (20.03)	State of source 2 (20.04)	Command	0	Any	Stop	0 -> 1 (20.02 = Edge)	0	Start forward	1 (20.02 = Level)	1	Start reverse	2			
State of source 1 (20.03)	State of source 2 (20.04)	Command																
0	Any	Stop																
0 -> 1 (20.02 = Edge)	0	Start forward																
1 (20.02 = Level)	1	Start reverse																
	In1 Start fwd; In2 Start rev	The source selected by 20.03 <i>Ext1 in1 source</i> is the forward start signal; the source selected by 20.04 <i>Ext1 in2 source</i> is the reverse start signal. The state transitions of the source bits are interpreted as follows: <table border="1" data-bbox="396 1011 902 1219"> <thead> <tr> <th>State of source 1 (20.03)</th> <th>State of source 2 (20.04)</th> <th>Command</th> </tr> </thead> <tbody> <tr> <td>0</td> <td>0</td> <td>Stop</td> </tr> <tr> <td>0 -&gt; 1 (20.02 = Edge) 1 (20.02 = Level)</td> <td>0</td> <td>Start forward</td> </tr> <tr> <td>0</td> <td>0 -&gt; 1 (20.02 = Edge) 1 (20.02 = Level)</td> <td>Start reverse</td> </tr> <tr> <td>1</td> <td>1</td> <td>Stop</td> </tr> </tbody> </table>	State of source 1 (20.03)	State of source 2 (20.04)	Command	0	0	Stop	0 -> 1 (20.02 = Edge) 1 (20.02 = Level)	0	Start forward	0	0 -> 1 (20.02 = Edge) 1 (20.02 = Level)	Start reverse	1	1	Stop	3
State of source 1 (20.03)	State of source 2 (20.04)	Command																
0	0	Stop																
0 -> 1 (20.02 = Edge) 1 (20.02 = Level)	0	Start forward																
0	0 -> 1 (20.02 = Edge) 1 (20.02 = Level)	Start reverse																
1	1	Stop																

No.	Name/Value	Description	Def/FbEq16																
	In1P Start; In2 Stop	<p>The sources of the start and stop commands are selected by parameters <a href="#">20.03 Ext1 in1 source</a> and <a href="#">20.04 Ext1 in2 source</a>. The state transitions of the source bits are interpreted as follows:</p> <table border="1"> <thead> <tr> <th>State of source 1 (20.03)</th> <th>State of source 2 (20.04)</th> <th>Command</th> </tr> </thead> <tbody> <tr> <td>0 -&gt; 1</td> <td>1</td> <td>Start</td> </tr> <tr> <td>Any</td> <td>0</td> <td>Stop</td> </tr> </tbody> </table> <p><b>Notes:</b></p> <ul style="list-style-type: none"> <li>Parameter <a href="#">20.02 Ext1 start trigger type</a> has no effect with this setting.</li> <li>When source 2 is 0, the Start and Stop keys on the control panel are disabled.</li> </ul>	State of source 1 (20.03)	State of source 2 (20.04)	Command	0 -> 1	1	Start	Any	0	Stop	4							
State of source 1 (20.03)	State of source 2 (20.04)	Command																	
0 -> 1	1	Start																	
Any	0	Stop																	
	In1P Start; In2 Stop; In3 Dir	<p>The sources of the start and stop commands are selected by parameters <a href="#">20.03 Ext1 in1 source</a> and <a href="#">20.04 Ext1 in2 source</a>. The source selected by <a href="#">20.05 Ext1 in3 source</a> determines the direction. The state transitions of the source bits are interpreted as follows:</p> <table border="1"> <thead> <tr> <th>State of source 1 (20.03)</th> <th>State of source 2 (20.04)</th> <th>State of source 3 (20.05)</th> <th>Command</th> </tr> </thead> <tbody> <tr> <td>0 -&gt; 1</td> <td>1</td> <td>0</td> <td>Start forward</td> </tr> <tr> <td>0 -&gt; 1</td> <td>1</td> <td>1</td> <td>Start reverse</td> </tr> <tr> <td>Any</td> <td>0</td> <td>Any</td> <td>Stop</td> </tr> </tbody> </table> <p><b>Notes:</b></p> <ul style="list-style-type: none"> <li>Parameter <a href="#">20.02 Ext1 start trigger type</a> has no effect with this setting.</li> <li>When source 2 is 0, the Start and Stop keys on the control panel are disabled.</li> </ul>	State of source 1 (20.03)	State of source 2 (20.04)	State of source 3 (20.05)	Command	0 -> 1	1	0	Start forward	0 -> 1	1	1	Start reverse	Any	0	Any	Stop	5
State of source 1 (20.03)	State of source 2 (20.04)	State of source 3 (20.05)	Command																
0 -> 1	1	0	Start forward																
0 -> 1	1	1	Start reverse																
Any	0	Any	Stop																
	In1P Start fwd; In2P Start rev; In3 Stop	<p>The sources of the start and stop commands are selected by parameters <a href="#">20.03 Ext1 in1 source</a>, <a href="#">20.04 Ext1 in2 source</a> and <a href="#">20.05 Ext1 in3 source</a>. The source selected by <a href="#">20.05 Ext1 in3 source</a> determines the stop. The state transitions of the source bits are interpreted as follows:</p> <table border="1"> <thead> <tr> <th>State of source 1 (20.03)</th> <th>State of source 2 (20.04)</th> <th>State of source 3 (20.05)</th> <th>Command</th> </tr> </thead> <tbody> <tr> <td>0 -&gt; 1</td> <td>Any</td> <td>1</td> <td>Start forward</td> </tr> <tr> <td>Any</td> <td>0 -&gt; 1</td> <td>1</td> <td>Start reverse</td> </tr> <tr> <td>Any</td> <td>Any</td> <td>0</td> <td>Stop</td> </tr> </tbody> </table> <p><b>Note:</b> Parameter <a href="#">20.02 Ext1 start trigger type</a> has no effect with this setting.</p>	State of source 1 (20.03)	State of source 2 (20.04)	State of source 3 (20.05)	Command	0 -> 1	Any	1	Start forward	Any	0 -> 1	1	Start reverse	Any	Any	0	Stop	6
State of source 1 (20.03)	State of source 2 (20.04)	State of source 3 (20.05)	Command																
0 -> 1	Any	1	Start forward																
Any	0 -> 1	1	Start reverse																
Any	Any	0	Stop																
	Reserved		7...10																
	Control panel	The start and stop commands are taken from the control panel (or PC connected to the control panel connector).	11																
	Fieldbus A	The start and stop commands are taken from fieldbus adapter A. <b>Note:</b> Set also <a href="#">20.02 Ext1 start trigger type</a> to <i>Level</i> .	12																
	Reserved		13																



No.	Name/Value	Description	Def/FbEq16
	Embedded fieldbus	The start and stop commands are taken from the embedded fieldbus interface. <b>Note:</b> Set also <a href="#">20.02 Ext1 start trigger type</a> to <i>Level</i> .	14
<a href="#">20.02</a>	<a href="#">Ext1 start trigger type</a>	Defines whether the start signal for external control location EXT1 is edge-triggered or level-triggered. <b>Note:</b> This parameter is not effective if a pulse-type start signal is selected. See the descriptions of the selections of parameter <a href="#">20.01 Ext1 commands</a> .	<i>Level</i>
	Edge	The start signal is edge-triggered.	0
	Level	The start signal is level-triggered.	1
<a href="#">20.03</a>	<a href="#">Ext1 in1 source</a>	Selects source 1 for parameter <a href="#">20.01 Ext1 commands</a> .	<i>DI1</i>
	Always off	Always off.	0
	Always on	Always on.	1
	DI1	Digital input DI1 ( <a href="#">10.02 DI delayed status</a> , bit 0).	2
	DI2	Digital input DI2 ( <a href="#">10.02 DI delayed status</a> , bit 1).	3
	DI3	Digital input DI3 ( <a href="#">10.02 DI delayed status</a> , bit 2).	4
	DI4	Digital input DI4 ( <a href="#">10.02 DI delayed status</a> , bit 3).	5
	DI5	Digital input DI5 ( <a href="#">10.02 DI delayed status</a> , bit 4).	6
	DI6	Digital input DI6 ( <a href="#">10.02 DI delayed status</a> , bit 5).	7
	Reserved		8...17
	Timed function 1	Bit 0 of <a href="#">34.01 Timed functions status</a> (see page <a href="#">327</a> ).	18
	Timed function 2	Bit 1 of <a href="#">34.01 Timed functions status</a> (see page <a href="#">327</a> ).	19
	Timed function 3	Bit 2 of <a href="#">34.01 Timed functions status</a> (see page <a href="#">327</a> ).	20
	Reserved		21...23
	Supervision 1	Bit 0 of <a href="#">32.01 Supervision status</a> (see page <a href="#">319</a> ).	24
	Supervision 2	Bit 1 of <a href="#">32.01 Supervision status</a> (see page <a href="#">319</a> ).	25
	Supervision 3	Bit 2 of <a href="#">32.01 Supervision status</a> (see page <a href="#">319</a> ).	26
	<i>Other [bit]</i>	Source selection (see <a href="#">Terms and abbreviations</a> on page <a href="#">196</a> ).	-
<a href="#">20.04</a>	<a href="#">Ext1 in2 source</a>	Selects source 2 for parameter <a href="#">20.01 Ext1 commands</a> . For the available selections, see parameter <a href="#">20.03 Ext1 in1 source</a> .	<i>DI2</i>
<a href="#">20.05</a>	<a href="#">Ext1 in3 source</a>	Selects source 3 for parameter <a href="#">20.01 Ext1 commands</a> . For the available selections, see parameter <a href="#">20.03 Ext1 in1 source</a> .	<i>Always off</i>
<a href="#">20.06</a>	<a href="#">Ext2 commands</a>	Selects the source of start, stop and direction commands for external control location 2 (EXT2). See parameter <a href="#">20.21</a> for the determination of the actual direction. See also parameters <a href="#">20.07...20.10</a> .	<i>Not selected</i>
	Not selected	No start or stop command sources selected.	0

No.	Name/Value	Description	Def/FbEq16																		
	In1 Start	<p>The source of the start and stop commands is selected by parameter <a href="#">20.08 Ext2 in1 source</a>. The state transitions of the source bits are interpreted as follows:</p> <table border="1"> <thead> <tr> <th>State of source 1 (<a href="#">20.08</a>)</th> <th>Command</th> </tr> </thead> <tbody> <tr> <td>0 -&gt; 1 (<a href="#">20.07 = Edge</a>)</td> <td>Start</td> </tr> <tr> <td>1 (<a href="#">20.07 = Level</a>)</td> <td>Stop</td> </tr> </tbody> </table>	State of source 1 ( <a href="#">20.08</a> )	Command	0 -> 1 ( <a href="#">20.07 = Edge</a> )	Start	1 ( <a href="#">20.07 = Level</a> )	Stop	1												
State of source 1 ( <a href="#">20.08</a> )	Command																				
0 -> 1 ( <a href="#">20.07 = Edge</a> )	Start																				
1 ( <a href="#">20.07 = Level</a> )	Stop																				
	In1 Start; In2 Dir	<p>The source selected by <a href="#">20.08 Ext2 in1 source</a> is the start signal; the source selected by <a href="#">20.09 Ext2 in2 source</a> determines the direction. The state transitions of the source bits are interpreted as follows:</p> <table border="1"> <thead> <tr> <th>State of source 1 (<a href="#">20.08</a>)</th> <th>State of source 2 (<a href="#">20.09</a>)</th> <th>Command</th> </tr> </thead> <tbody> <tr> <td>0</td> <td>Any</td> <td>Stop</td> </tr> <tr> <td>0 -&gt; 1 (<a href="#">20.07 = Edge</a>)</td> <td>0</td> <td>Start forward</td> </tr> <tr> <td>1 (<a href="#">20.07 = Level</a>)</td> <td>1</td> <td>Start reverse</td> </tr> </tbody> </table>	State of source 1 ( <a href="#">20.08</a> )	State of source 2 ( <a href="#">20.09</a> )	Command	0	Any	Stop	0 -> 1 ( <a href="#">20.07 = Edge</a> )	0	Start forward	1 ( <a href="#">20.07 = Level</a> )	1	Start reverse	2						
State of source 1 ( <a href="#">20.08</a> )	State of source 2 ( <a href="#">20.09</a> )	Command																			
0	Any	Stop																			
0 -> 1 ( <a href="#">20.07 = Edge</a> )	0	Start forward																			
1 ( <a href="#">20.07 = Level</a> )	1	Start reverse																			
	In1 Start fwd; In2 Start rev	<p>The source selected by <a href="#">20.08 Ext2 in1 source</a> is the forward start signal; the source selected by <a href="#">20.09 Ext2 in2 source</a> is the reverse start signal. The state transitions of the source bits are interpreted as follows:</p> <table border="1"> <thead> <tr> <th>State of source 1 (<a href="#">20.08</a>)</th> <th>State of source 2 (<a href="#">20.09</a>)</th> <th>Command</th> </tr> </thead> <tbody> <tr> <td>0</td> <td>0</td> <td>Stop</td> </tr> <tr> <td>0 -&gt; 1 (<a href="#">20.07 = Edge</a>)</td> <td>0</td> <td>Start forward</td> </tr> <tr> <td>1 (<a href="#">20.07 = Level</a>)</td> <td>0 -&gt; 1 (<a href="#">20.07 = Edge</a>)</td> <td>Start reverse</td> </tr> <tr> <td>0</td> <td>1 (<a href="#">20.07 = Level</a>)</td> <td>Start reverse</td> </tr> <tr> <td>1</td> <td>1</td> <td>Stop</td> </tr> </tbody> </table>	State of source 1 ( <a href="#">20.08</a> )	State of source 2 ( <a href="#">20.09</a> )	Command	0	0	Stop	0 -> 1 ( <a href="#">20.07 = Edge</a> )	0	Start forward	1 ( <a href="#">20.07 = Level</a> )	0 -> 1 ( <a href="#">20.07 = Edge</a> )	Start reverse	0	1 ( <a href="#">20.07 = Level</a> )	Start reverse	1	1	Stop	3
State of source 1 ( <a href="#">20.08</a> )	State of source 2 ( <a href="#">20.09</a> )	Command																			
0	0	Stop																			
0 -> 1 ( <a href="#">20.07 = Edge</a> )	0	Start forward																			
1 ( <a href="#">20.07 = Level</a> )	0 -> 1 ( <a href="#">20.07 = Edge</a> )	Start reverse																			
0	1 ( <a href="#">20.07 = Level</a> )	Start reverse																			
1	1	Stop																			
	In1P Start; In2 Stop	<p>The sources of the start and stop commands are selected by parameters <a href="#">20.08 Ext2 in1 source</a> and <a href="#">20.09 Ext2 in2 source</a>. The state transitions of the source bits are interpreted as follows:</p> <table border="1"> <thead> <tr> <th>State of source 1 (<a href="#">20.08</a>)</th> <th>State of source 2 (<a href="#">20.09</a>)</th> <th>Command</th> </tr> </thead> <tbody> <tr> <td>0 -&gt; 1</td> <td>1</td> <td>Start</td> </tr> <tr> <td>Any</td> <td>0</td> <td>Stop</td> </tr> </tbody> </table> <p><b>Notes:</b></p> <ul style="list-style-type: none"> <li>Parameter <a href="#">20.07 Ext2 start trigger type</a> has no effect with this setting.</li> <li>When source 2 is 0, the Start and Stop keys on the control panel are disabled.</li> </ul>	State of source 1 ( <a href="#">20.08</a> )	State of source 2 ( <a href="#">20.09</a> )	Command	0 -> 1	1	Start	Any	0	Stop	4									
State of source 1 ( <a href="#">20.08</a> )	State of source 2 ( <a href="#">20.09</a> )	Command																			
0 -> 1	1	Start																			
Any	0	Stop																			

No.	Name/Value	Description	Def/FbEq16																
	In1P Start; In2 Stop; In3 Dir	<p>The sources of the start and stop commands are selected by parameters <a href="#">20.08 Ext2 in1 source</a> and <a href="#">20.09 Ext2 in2 source</a>. The source selected by <a href="#">20.10 Ext2 in3 source</a> determines the direction. The state transitions of the source bits are interpreted as follows:</p> <table border="1"> <thead> <tr> <th>State of source 1 (<a href="#">20.08</a>)</th> <th>State of source 2 (<a href="#">20.09</a>)</th> <th>State of source 3 (<a href="#">20.10</a>)</th> <th>Command</th> </tr> </thead> <tbody> <tr> <td>0 -&gt; 1</td> <td>1</td> <td>0</td> <td>Start forward</td> </tr> <tr> <td>0 -&gt; 1</td> <td>1</td> <td>1</td> <td>Start reverse</td> </tr> <tr> <td>Any</td> <td>0</td> <td>Any</td> <td>Stop</td> </tr> </tbody> </table> <p><b>Notes:</b></p> <ul style="list-style-type: none"> <li>Parameter <a href="#">20.07 Ext2 start trigger type</a> has no effect with this setting.</li> <li>When source 2 is 0, the Start and Stop keys on the control panel are disabled.</li> </ul>	State of source 1 ( <a href="#">20.08</a> )	State of source 2 ( <a href="#">20.09</a> )	State of source 3 ( <a href="#">20.10</a> )	Command	0 -> 1	1	0	Start forward	0 -> 1	1	1	Start reverse	Any	0	Any	Stop	5
State of source 1 ( <a href="#">20.08</a> )	State of source 2 ( <a href="#">20.09</a> )	State of source 3 ( <a href="#">20.10</a> )	Command																
0 -> 1	1	0	Start forward																
0 -> 1	1	1	Start reverse																
Any	0	Any	Stop																
	In1P Start fwd; In2P Start rev; In3 Stop	<p>The sources of the start and stop commands are selected by parameters <a href="#">20.08 Ext2 in1 source</a>, <a href="#">20.09 Ext2 in2 source</a> and <a href="#">20.10 Ext2 in3 source</a>. The source selected by <a href="#">20.10 Ext2 in3 source</a> determines the direction. The state transitions of the source bits are interpreted as follows:</p> <table border="1"> <thead> <tr> <th>State of source 1 (<a href="#">20.08</a>)</th> <th>State of source 2 (<a href="#">20.09</a>)</th> <th>State of source 3 (<a href="#">20.10</a>)</th> <th>Command</th> </tr> </thead> <tbody> <tr> <td>0 -&gt; 1</td> <td>Any</td> <td>1</td> <td>Start forward</td> </tr> <tr> <td>Any</td> <td>0 -&gt; 1</td> <td>1</td> <td>Start reverse</td> </tr> <tr> <td>Any</td> <td>Any</td> <td>0</td> <td>Stop</td> </tr> </tbody> </table> <p><b>Note:</b> Parameter <a href="#">20.07 Ext2 start trigger type</a> has no effect with this setting.</p>	State of source 1 ( <a href="#">20.08</a> )	State of source 2 ( <a href="#">20.09</a> )	State of source 3 ( <a href="#">20.10</a> )	Command	0 -> 1	Any	1	Start forward	Any	0 -> 1	1	Start reverse	Any	Any	0	Stop	6
State of source 1 ( <a href="#">20.08</a> )	State of source 2 ( <a href="#">20.09</a> )	State of source 3 ( <a href="#">20.10</a> )	Command																
0 -> 1	Any	1	Start forward																
Any	0 -> 1	1	Start reverse																
Any	Any	0	Stop																
	Reserved		7...10																
	Control panel	The start and stop commands are taken from the control panel (or PC connected to the control panel connector).	11																
	Fieldbus A	The start and stop commands are taken from fieldbus adapter A. <b>Note:</b> Set also <a href="#">20.07 Ext2 start trigger type</a> to <i>Level</i> .	12																
	Reserved		13																
	Embedded fieldbus	The start and stop commands are taken from the embedded fieldbus interface. <b>Note:</b> Set also <a href="#">20.07 Ext2 start trigger type</a> to <i>Level</i> .	14																
<a href="#">20.07</a>	<a href="#">Ext2 start trigger type</a>	<p>Defines whether the start signal for external control location EXT2 is edge-triggered or level-triggered.</p> <p><b>Note:</b> This parameter is not effective if a pulse-type start signal is selected. See the descriptions of the selections of parameter <a href="#">20.06 Ext2 commands</a>.</p>	<i>Level</i>																
	Edge	The start signal is edge-triggered.	0																
	Level	The start signal is level-triggered.	1																
<a href="#">20.08</a>	<a href="#">Ext2 in1 source</a>	<p>Selects source 1 for parameter <a href="#">20.06 Ext2 commands</a>. For the available selections, see parameter <a href="#">20.03 Ext1 in1 source</a>.</p>	<i>Always off</i>																

No.	Name/Value	Description	Def/FbEq16
20.09	<i>Ext2 in2 source</i>	Selects source 2 for parameter <i>20.06 Ext2 commands</i> . For the available selections, see parameter <i>20.03 Ext1 in1 source</i> .	<i>Always off</i>
20.10	<i>Ext2 in3 source</i>	Selects source 3 for parameter <i>20.06 Ext2 commands</i> . For the available selections, see parameter <i>20.03 Ext1 in1 source</i> .	<i>Always off</i>
20.11	<i>Run enable stop mode</i>	Selects the way the motor is stopped when the run enable signal switches off. The source of the run enable signal is selected by parameter <i>20.12 Run enable 1 source</i> .	<i>Coast</i>
	Coast	Stop by switching off the output semiconductors of the drive. The motor coasts to a stop.  <b>WARNING!</b> If a mechanical brake is used, ensure it is safe to stop the drive by coasting.	0
	Ramp	Stop along the active deceleration ramp. See parameter group <i>23 Speed reference ramp</i> on page 276.	1
	Torque limit	Stop according to torque limits (parameters <i>30.19</i> and <i>30.20</i> ).	2
20.12	<i>Run enable 1 source</i>	Selects the source of the external run enable signal. If the run enable signal is switched off, the drive will not start. If already running, the drive will stop according to the setting of parameter <i>20.11 Run enable stop mode</i> . 1 = Run enable signal on. See also parameter <i>20.19 Enable start command</i> .	<i>Selected</i>
	Not selected	0.	0
	Selected	1.	1
	DI1	Digital input DI1 ( <i>10.02 DI delayed status</i> , bit 0).	2
	DI2	Digital input DI2 ( <i>10.02 DI delayed status</i> , bit 1).	3
	DI3	Digital input DI3 ( <i>10.02 DI delayed status</i> , bit 2).	4
	DI4	Digital input DI4 ( <i>10.02 DI delayed status</i> , bit 3).	5
	DI5	Digital input DI5 ( <i>10.02 DI delayed status</i> , bit 4).	6
	DI6	Digital input DI6 ( <i>10.02 DI delayed status</i> , bit 5).	7
	Reserved		8...17
	Timed function 1	Bit 0 of <i>34.01 Timed functions status</i> (see page 327).	18
	Timed function 2	Bit 1 of <i>34.01 Timed functions status</i> (see page 327).	19
	Timed function 3	Bit 2 of <i>34.01 Timed functions status</i> (see page 327).	20
	Reserved		21...23
	Supervision 1	Bit 0 of <i>32.01 Supervision status</i> (see page 319).	24
	Supervision 2	Bit 1 of <i>32.01 Supervision status</i> (see page 319).	25
	Supervision 3	Bit 2 of <i>32.01 Supervision status</i> (see page 319).	26
	Reserved		27...29
	FBA A MCW bit 3	Control word bit 3 received through fieldbus interface A.	30
	Reserved		31
	EFB MCW bit 3	Control word bit 3 received through the embedded fieldbus interface.	32
	<i>Other [bit]</i>	Source selection (see <i>Terms and abbreviations</i> on page 196).	-

No.	Name/Value	Description	Def/FbEq16
20.19	<i>Enable start command</i>	Selects the source for the start enable signal. 1 = Start enable. With the signal switched off, any drive start command is inhibited. (Switching the signal off while the drive is running will not stop the drive.) See also parameter <a href="#">20.12 Run enable 1 source</a> .	<i>Selected</i>
	Not selected	0.	0
	Selected	1.	1
	DI1	Digital input DI1 ( <a href="#">10.02 DI delayed status</a> , bit 0).	2
	DI2	Digital input DI2 ( <a href="#">10.02 DI delayed status</a> , bit 1).	3
	DI3	Digital input DI3 ( <a href="#">10.02 DI delayed status</a> , bit 2).	4
	DI4	Digital input DI4 ( <a href="#">10.02 DI delayed status</a> , bit 3).	5
	DI5	Digital input DI5 ( <a href="#">10.02 DI delayed status</a> , bit 4).	6
	DI6	Digital input DI6 ( <a href="#">10.02 DI delayed status</a> , bit 5).	7
	Reserved		8...17
	Timed function 1	Bit 0 of <a href="#">34.01 Timed functions status</a> (see page <a href="#">327</a> ).	18
	Timed function 2	Bit 1 of <a href="#">34.01 Timed functions status</a> (see page <a href="#">327</a> ).	19
	Timed function 3	Bit 2 of <a href="#">34.01 Timed functions status</a> (see page <a href="#">327</a> ).	20
	Reserved		21...23
	Supervision 1	Bit 0 of <a href="#">32.01 Supervision status</a> (see page <a href="#">319</a> ).	24
	Supervision 2	Bit 1 of <a href="#">32.01 Supervision status</a> (see page <a href="#">319</a> ).	25
	Supervision 3	Bit 2 of <a href="#">32.01 Supervision status</a> (see page <a href="#">319</a> ).	26
	<i>Other [bit]</i>	Source selection (see <a href="#">Terms and abbreviations</a> on page <a href="#">196</a> ).	-

No.	Name/Value	Description	Def/FbEq16																
20.21	<i>Direction</i>	Reference direction lock. Defines the direction of the drive rather than the sign of the reference, except in some cases. In the table the actual drive rotation is shown as a function of parameter <i>20.21 Direction</i> and Direction command (from parameter <i>20.01 Ext1 commands</i> or <i>20.06 Ext2 commands</i> ).	<i>Request</i>																
		<table border="1"> <thead> <tr> <th></th> <th>Direction command = Forward</th> <th>Direction command = Reverse</th> <th>Direction command not defined</th> </tr> </thead> <tbody> <tr> <td>Par. <i>20.21 Direction</i> = <i>Forward</i></td> <td>Forward</td> <td>Forward</td> <td>Forward</td> </tr> <tr> <td>Par. <i>20.21 Direction</i> = <i>Reverse</i></td> <td>Reverse</td> <td>Reverse</td> <td>Reverse</td> </tr> <tr> <td>Par. <i>20.21 Direction</i> = <i>Request</i></td> <td>Forward, but                             <ul style="list-style-type: none"> <li>If reference from Constant, Motor potentiometer, PID, Safe speed, Last, Jogging or Panel reference, reference used as is.</li> <li>If reference from the network, reference used as is.</li> </ul> </td> <td>Reverse, but                             <ul style="list-style-type: none"> <li>If reference from Constant, PID or Jogging reference, reference used as is.</li> <li>If reference from the network, Panel, Analog input, Motor potentiometer, Safe speed or Last reference, reference multiplied by -1.</li> </ul> </td> <td>Forward</td> </tr> </tbody> </table>		Direction command = Forward	Direction command = Reverse	Direction command not defined	Par. <i>20.21 Direction</i> = <i>Forward</i>	Forward	Forward	Forward	Par. <i>20.21 Direction</i> = <i>Reverse</i>	Reverse	Reverse	Reverse	Par. <i>20.21 Direction</i> = <i>Request</i>	Forward, but <ul style="list-style-type: none"> <li>If reference from Constant, Motor potentiometer, PID, Safe speed, Last, Jogging or Panel reference, reference used as is.</li> <li>If reference from the network, reference used as is.</li> </ul>	Reverse, but <ul style="list-style-type: none"> <li>If reference from Constant, PID or Jogging reference, reference used as is.</li> <li>If reference from the network, Panel, Analog input, Motor potentiometer, Safe speed or Last reference, reference multiplied by -1.</li> </ul>	Forward	
	Direction command = Forward	Direction command = Reverse	Direction command not defined																
Par. <i>20.21 Direction</i> = <i>Forward</i>	Forward	Forward	Forward																
Par. <i>20.21 Direction</i> = <i>Reverse</i>	Reverse	Reverse	Reverse																
Par. <i>20.21 Direction</i> = <i>Request</i>	Forward, but <ul style="list-style-type: none"> <li>If reference from Constant, Motor potentiometer, PID, Safe speed, Last, Jogging or Panel reference, reference used as is.</li> <li>If reference from the network, reference used as is.</li> </ul>	Reverse, but <ul style="list-style-type: none"> <li>If reference from Constant, PID or Jogging reference, reference used as is.</li> <li>If reference from the network, Panel, Analog input, Motor potentiometer, Safe speed or Last reference, reference multiplied by -1.</li> </ul>	Forward																
	Request	In external control the direction is selected by a direction command (parameter <i>20.01 Ext1 commands</i> or <i>20.06 Ext2 commands</i> ). If the reference comes from Constant (constant speeds/frequencies), Motor potentiometer, PID, Speed ref safe, Last speed reference, Jogging speed or Panel reference, the reference is used as is. If the reference comes from a fieldbus: <ul style="list-style-type: none"> <li>if the direction command is forward, the reference is used as is</li> <li>if the direction command is reverse, the reference is multiplied by -1.</li> </ul>	0																
	Forward	Motor rotates forward regardless of the sign of the external reference. (Negative reference values are replaced by zero. Positive reference values are used as is.)	1																
	Reverse	Motor rotates reverse regardless of the sign of the external reference. (Negative reference values are replaced by zero. Positive reference values are multiplied by -1.)	2																
20.22	<i>Enable to rotate</i>	Setting this parameter to 0 stops motor rotating but does not affect any other conditions for rotating. Setting the parameter back to 1 starts motor rotating again. This parameter can be used for example with a signal from some external equipment to prevent the motor rotating before the equipment is ready. When this parameter is 0 (rotating of the motor is disabled), bit 13 of parameter <i>06.16 Drive status word 1</i> is set to 0.	<i>Selected</i>																
	Not selected	0 (always off).	0																
	Selected	1 (always on).	1																

No.	Name/Value	Description	Def/FbEq16
	DI1	Digital input DI1 ( <a href="#">10.02 DI delayed status</a> , bit 0).	2
	DI2	Digital input DI2 ( <a href="#">10.02 DI delayed status</a> , bit 1).	3
	DI3	Digital input DI3 ( <a href="#">10.02 DI delayed status</a> , bit 2).	4
	DI4	Digital input DI4 ( <a href="#">10.02 DI delayed status</a> , bit 3).	5
	DI5	Digital input DI5 ( <a href="#">10.02 DI delayed status</a> , bit 4).	6
	DI6	Digital input DI6 ( <a href="#">10.02 DI delayed status</a> , bit 5).	7
	Reserved		8...17
	Timed function 1	Bit 0 of <a href="#">34.01 Timed functions status</a> (see page <a href="#">327</a> ).	18
	Timed function 2	Bit 1 of <a href="#">34.01 Timed functions status</a> (see page <a href="#">327</a> ).	19
	Timed function 3	Bit 2 of <a href="#">34.01 Timed functions status</a> (see page <a href="#">327</a> ).	20
	Reserved		21...23
	Supervision 1	Bit 0 of <a href="#">32.01 Supervision status</a> (see page <a href="#">319</a> ).	24
	Supervision 2	Bit 1 of <a href="#">32.01 Supervision status</a> (see page <a href="#">319</a> ).	25
	Supervision 3	Bit 2 of <a href="#">32.01 Supervision status</a> (see page <a href="#">319</a> ).	26
	<i>Other [bit]</i>	Source selection (see <a href="#">Terms and abbreviations</a> on page <a href="#">196</a> ).	-
<a href="#">20.25</a>	<a href="#">Jogging enable</a>	<p>Selects the source for a jog enable signal. (The sources for jogging activation signals are selected by parameters <a href="#">20.26 Jogging 1 start source</a> and <a href="#">20.27 Jogging 2 start source</a>.)</p> <p>1 = Jogging is enabled. 0 = Jogging is disabled.</p> <p><b>Notes:</b></p> <ul style="list-style-type: none"> <li>Jogging is supported in vector control mode only.</li> <li>Jogging can be enabled only when no start command from an external control location is active. On the other hand, if jogging is already enabled, the drive cannot be started from an external control location (apart from inching commands through fieldbus).</li> <li>See section <a href="#">Rush control</a> (page <a href="#">165</a>).</li> </ul>	<i>Not selected</i>
	Not selected	0.	0
	Selected	1.	1
	DI1	Digital input DI1 ( <a href="#">10.02 DI delayed status</a> , bit 0).	2
	DI2	Digital input DI2 ( <a href="#">10.02 DI delayed status</a> , bit 1).	3
	DI3	Digital input DI3 ( <a href="#">10.02 DI delayed status</a> , bit 2).	4
	DI4	Digital input DI4 ( <a href="#">10.02 DI delayed status</a> , bit 3).	5
	DI5	Digital input DI5 ( <a href="#">10.02 DI delayed status</a> , bit 4).	6
	DI6	Digital input DI6 ( <a href="#">10.02 DI delayed status</a> , bit 5).	7
	Reserved		8...17
	Timed function 1	Bit 0 of <a href="#">34.01 Timed functions status</a> (see page <a href="#">327</a> ).	18
	Timed function 2	Bit 1 of <a href="#">34.01 Timed functions status</a> (see page <a href="#">327</a> ).	19
	Timed function 3	Bit 2 of <a href="#">34.01 Timed functions status</a> (see page <a href="#">327</a> ).	20
	Reserved		21...23
	Supervision 1	Bit 0 of <a href="#">32.01 Supervision status</a> (see page <a href="#">319</a> ).	24
	Supervision 2	Bit 1 of <a href="#">32.01 Supervision status</a> (see page <a href="#">319</a> ).	25
	Supervision 3	Bit 2 of <a href="#">32.01 Supervision status</a> (see page <a href="#">319</a> ).	26

No.	Name/Value	Description	Def/FbEq16
	<i>Other [bit]</i>	Source selection (see <a href="#">Terms and abbreviations</a> on page 196).	-
20.26	<i>Jogging 1 start source</i>	<p>If enabled by parameter <a href="#">20.25 Jogging enable</a>, selects the source for the activation of jogging function 1. (Jogging function 1 can also be activated through fieldbus regardless of parameter <a href="#">20.25</a>.)</p> <p>1 = Jogging 1 active.</p> <p><b>Notes:</b></p> <ul style="list-style-type: none"> <li>Jogging is supported in vector control mode only.</li> <li>If both jogging 1 and 2 are activated, the one that was activated first has priority.</li> <li>This parameter cannot be changed while the drive is running.</li> </ul>	<i>Not selected</i>
	Not selected	0.	0
	Selected	1.	1
	DI1	Digital input DI1 ( <a href="#">10.02 DI delayed status</a> , bit 0).	2
	DI2	Digital input DI2 ( <a href="#">10.02 DI delayed status</a> , bit 1).	3
	DI3	Digital input DI3 ( <a href="#">10.02 DI delayed status</a> , bit 2).	4
	DI4	Digital input DI4 ( <a href="#">10.02 DI delayed status</a> , bit 3).	5
	DI5	Digital input DI5 ( <a href="#">10.02 DI delayed status</a> , bit 4).	6
	DI6	Digital input DI6 ( <a href="#">10.02 DI delayed status</a> , bit 5).	7
	Reserved		8...17
	Timed function 1	Bit 0 of <a href="#">34.01 Timed functions status</a> (see page 327).	18
	Timed function 2	Bit 1 of <a href="#">34.01 Timed functions status</a> (see page 327).	19
	Timed function 3	Bit 2 of <a href="#">34.01 Timed functions status</a> (see page 327).	20
	Reserved		21...23
	Supervision 1	Bit 0 of <a href="#">32.01 Supervision status</a> (see page 319).	24
	Supervision 2	Bit 1 of <a href="#">32.01 Supervision status</a> (see page 319).	25
	Supervision 3	Bit 2 of <a href="#">32.01 Supervision status</a> (see page 319).	26
	<i>Other [bit]</i>	Source selection (see <a href="#">Terms and abbreviations</a> on page 196).	-
20.27	<i>Jogging 2 start source</i>	<p>If enabled by parameter <a href="#">20.25 Jogging enable</a>, selects the source for the activation of jogging function 2. (Jogging function 2 can also be activated through fieldbus regardless of parameter <a href="#">20.25</a>.)</p> <p>1 = Jogging 2 active.</p> <p>For the selections, see parameter <a href="#">20.26 Jogging 1 start source</a>.</p> <p><b>Notes:</b></p> <ul style="list-style-type: none"> <li>Jogging is supported in vector control mode only.</li> <li>If both jogging 1 and 2 are activated, the one that was activated first has priority.</li> <li>This parameter cannot be changed while the drive is running.</li> </ul>	<i>Not selected</i>



No.	Name/Value	Description	Def/FbEq16												
20.30	<i>Enable signal warning function</i>	Selects enable signal warnings to be suppressed. This parameter can be used to prevent these warnings from flooding the event log. Whenever a bit of this parameter is set to 1, the corresponding warning is suppressed.	0000h												
<table border="1"> <thead> <tr> <th>Bit</th> <th>Name</th> <th>Description</th> </tr> </thead> <tbody> <tr> <td>0</td> <td>Enable to rotate</td> <td>1 = Warning <i>AFED Enable to rotate</i> is suppressed.</td> </tr> <tr> <td>1</td> <td>Run enable missing</td> <td>1 = Warning <i>AFEB Run enable missing</i> is suppressed.</td> </tr> <tr> <td>3...15</td> <td>Reserved</td> <td></td> </tr> </tbody> </table>				Bit	Name	Description	0	Enable to rotate	1 = Warning <i>AFED Enable to rotate</i> is suppressed.	1	Run enable missing	1 = Warning <i>AFEB Run enable missing</i> is suppressed.	3...15	Reserved	
Bit	Name	Description													
0	Enable to rotate	1 = Warning <i>AFED Enable to rotate</i> is suppressed.													
1	Run enable missing	1 = Warning <i>AFEB Run enable missing</i> is suppressed.													
3...15	Reserved														
0000h...FFFFh			Word for disabling enable signal warnings.												
			1 = 1												

<b>21 Start/stop mode</b>		Start and stop modes; emergency stop mode and signal source selection; DC magnetization settings.	
21.01	<i>Start mode</i>	Selects the motor start function for the vector motor control mode, ie. when <i>99.04 Motor control mode</i> is set to <i>Vector</i> . <b>Notes:</b> <ul style="list-style-type: none"> <li>The start function for the scalar motor control mode is selected by parameter <i>21.19 Scalar start mode</i>.</li> <li>Starting into a rotating motor is not possible when DC magnetizing is selected (<i>Fast</i> or <i>Const time</i>).</li> <li>With permanent magnet motors, <i>Automatic</i> start mode must be used.</li> <li>This parameter cannot be changed while the drive is running.</li> </ul> See also section <i>DC magnetization</i> (page 161).	<i>Automatic</i>
	Fast	The drive pre-magnetizes the motor before start. The pre-magnetizing time is determined automatically, being typically 200 ms to 2 s depending on motor size. This mode should be selected if a high break-away torque is required.	0
	Const time	The drive pre-magnetizes the motor before start. The pre-magnetizing time is defined by parameter <i>21.02 Magnetization time</i> . This mode should be selected if constant pre-magnetizing time is required (for example, if the motor start must be synchronized with the release of a mechanical brake). This setting also guarantees the highest possible break-away torque when the pre-magnetizing time is set long enough.  <b>WARNING!</b> The drive will start after the set magnetizing time has passed even if motor magnetization is not completed. In applications where a full break-away torque is essential, ensure that the constant magnetizing time is long enough to allow generation of full magnetization and torque.	1
	Automatic	Automatic start guarantees optimal motor start in most cases. It includes the flying start function (starting into a rotating motor) and the automatic restart function. The drive motor control program identifies the flux as well as the mechanical state of the motor and starts the motor instantly under all conditions.	2

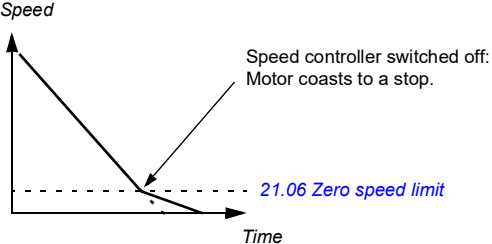
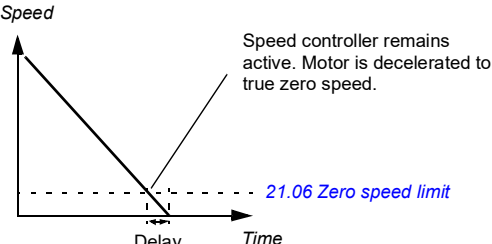

No.	Name/Value	Description	Def/FbEq16										
21.02	<i>Magnetization time</i>	<p>Defines the pre-magnetization time when</p> <ul style="list-style-type: none"> <li>parameter <a href="#">21.01 Start mode</a> is set to <i>Const time</i> (in vector motor control mode), or</li> <li>parameter <a href="#">21.19 Scalar start mode</a> is set to <i>Const time</i> or <i>Torque boost</i> (in scalar motor control mode).</li> </ul> <p>After the start command, the drive automatically premagnetizes the motor for the set time. To ensure full magnetizing, set this parameter to the same value as, or higher than, the rotor time constant. If not known, use the rule-of-thumb value given in the table below:</p> <table border="1" style="width: 100%; border-collapse: collapse;"> <thead> <tr> <th>Motor rated power</th> <th>Constant magnetizing time</th> </tr> </thead> <tbody> <tr> <td>&lt; 1 kW</td> <td>≥ 50 to 100 ms</td> </tr> <tr> <td>1 to 10 kW</td> <td>≥ 100 to 200 ms</td> </tr> <tr> <td>10 to 200 kW</td> <td>≥ 200 to 1000 ms</td> </tr> <tr> <td>200 to 1000 kW</td> <td>≥ 1000 to 2000 ms</td> </tr> </tbody> </table> <p><b>Note:</b> This parameter cannot be changed while the drive is running.</p>	Motor rated power	Constant magnetizing time	< 1 kW	≥ 50 to 100 ms	1 to 10 kW	≥ 100 to 200 ms	10 to 200 kW	≥ 200 to 1000 ms	200 to 1000 kW	≥ 1000 to 2000 ms	500 ms
Motor rated power	Constant magnetizing time												
< 1 kW	≥ 50 to 100 ms												
1 to 10 kW	≥ 100 to 200 ms												
10 to 200 kW	≥ 200 to 1000 ms												
200 to 1000 kW	≥ 1000 to 2000 ms												
	0...10000 ms	Constant DC magnetizing time.	1 = 1 ms										
21.03	<i>Stop mode</i>	<p>Selects the way the motor is stopped when a stop command is received.</p> <p>Additional braking is possible by selecting flux braking (see parameter <a href="#">97.05 Flux braking</a>).</p>	<i>Coast</i>										
	Coast	<p>Stop by switching off the output semiconductors of the drive. The motor coasts to a stop.</p> <p> <b>WARNING!</b> If a mechanical brake is used, ensure it is safe to stop the drive by coasting.</p>	0										
	Ramp	Stop along the active deceleration ramp. See parameter group <a href="#">23 Speed reference ramp</a> on page <a href="#">276</a> or <a href="#">28 Frequency reference chain</a> on page <a href="#">290</a> .	1										
	Torque limit	Stop according to torque limits (parameters <a href="#">30.19</a> and <a href="#">30.20</a> ). This mode is only possible in vector motor control mode.	2										
21.04	<i>Emergency stop mode</i>	<p>Selects the way the motor is stopped when an emergency stop command is received.</p> <p>The source of the emergency stop signal is selected by parameter <a href="#">21.05 Emergency stop source</a>.</p>	<i>Ramp stop (Off1)</i>										
	Ramp stop (Off1)	<p>With the drive running:</p> <ul style="list-style-type: none"> <li>1 = Normal operation.</li> <li>0 = Normal stop along the standard deceleration ramp defined for the particular reference type (see section <a href="#">Rush control</a> [page <a href="#">165</a>]). After the drive has stopped, it can be restarted by removing the emergency stop signal and switching the start signal from 0 to 1.</li> </ul> <p>With the drive stopped:</p> <ul style="list-style-type: none"> <li>1 = Starting allowed.</li> <li>0 = Starting not allowed.</li> </ul>	0										
	Coast stop (Off2)	<p>With the drive running:</p> <ul style="list-style-type: none"> <li>1 = Normal operation.</li> <li>0 = Stop by coasting.</li> </ul> <p>With the drive stopped:</p> <ul style="list-style-type: none"> <li>1 = Starting allowed.</li> <li>0 = Starting not allowed.</li> </ul>	1										

No.	Name/Value	Description	Def/FbEq16
	Eme ramp stop (Off3)	<p>With the drive running:</p> <ul style="list-style-type: none"> <li>• 1 = Normal operation</li> <li>• 0 = Stop by ramping along emergency stop ramp defined by parameter <a href="#">23.23 Emergency stop time</a>. After the drive has stopped, it can be restarted by removing the emergency stop signal and switching the start signal from 0 to 1.</li> </ul> <p>With the drive stopped:</p> <ul style="list-style-type: none"> <li>• 1 = Starting allowed.</li> <li>• 0 = Starting not allowed.</li> </ul>	2
<a href="#">21.05</a>	<a href="#">Emergency stop source</a>	<p>Selects the source of the emergency stop signal. The stop mode is selected by parameter <a href="#">21.04 Emergency stop mode</a>.</p> <p>0 = Emergency stop active. 1 = Normal operation</p> <p><b>Note:</b> This parameter cannot be changed while the drive is running.</p>	<i>Inactive (true)</i>
	Active (false)	0.	0
	Inactive (true)	1.	1
	Reserved		2
	DI1	Digital input DI1 ( <a href="#">10.02 DI delayed status</a> , bit 0).	3
	DI2	Digital input DI2 ( <a href="#">10.02 DI delayed status</a> , bit 1).	4
	DI3	Digital input DI3 ( <a href="#">10.02 DI delayed status</a> , bit 2).	5
	DI4	Digital input DI4 ( <a href="#">10.02 DI delayed status</a> , bit 3).	6
	DI5	Digital input DI5 ( <a href="#">10.02 DI delayed status</a> , bit 4).	7
	DI6	Digital input DI6 ( <a href="#">10.02 DI delayed status</a> , bit 5).	8
	<a href="#">Other [bit]</a>	Source selection (see <a href="#">Terms and abbreviations</a> on page 196).	-
<a href="#">21.06</a>	<a href="#">Zero speed limit</a>	<p>Defines the zero speed limit. The motor is stopped along a speed ramp (when ramped stop is selected or emergency stop time is used) until the defined zero speed limit is reached. After the zero speed delay, the motor coasts to a stop.</p>	30.00 rpm
	0.00...30000.00 rpm	Zero speed limit.	See par. <a href="#">46.01</a>

No.	Name/Value	Description	Def/FbEq16
21.07	<i>Zero speed delay</i>	<p>Defines the delay for the zero speed delay function. The function is useful in applications where a smooth and quick restarting is essential. During the delay, the drive knows the rotor position accurately.</p> <p><u>Without zero speed delay:</u> The drive receives a stop command and decelerates along a ramp. When actual motor speed falls below the value of parameter <i>21.06 Zero speed limit</i>, inverter modulation is stopped and the motor coasts to a standstill.</p>  <p><u>With zero speed delay:</u> The drive receives a stop command and decelerates along a ramp. When actual motor speed falls below the value of parameter <i>21.06 Zero speed limit</i>, the zero speed delay function activates. During the delay the function keeps the speed controller live: the inverter modulates, motor is magnetized and the drive is ready for a quick restart. Zero speed delay can be used, for example, with the jogging function.</p> 	0 ms
	0...30000 ms	Zero speed delay.	1 = 1 ms

No.	Name/Value	Description	Def/FbEq16															
21.08	<i>DC current control</i>	Activates/deactivates the DC hold and post-magnetization functions. See section <i>DC magnetization</i> (page 161). <b>Note:</b> DC magnetization causes the motor to heat up. In applications where long DC magnetization times are required, externally ventilated motors should be used. If the DC magnetization period is long, DC magnetization cannot prevent the motor shaft from rotating if a constant load is applied to the motor.	0000b															
		<table border="1"> <thead> <tr> <th>Bit</th> <th>Name</th> <th>Value</th> </tr> </thead> <tbody> <tr> <td>0</td> <td>DC hold</td> <td>1 = Enable DC hold. See section <i>DC hold</i> (page 162). <b>Note:</b> The DC hold function has no effect if the start signal is switched off.</td> </tr> <tr> <td>1</td> <td>Post-magnetization</td> <td>1 = Enable post-magnetization. See section <i>Settings and diagnostics</i> (page 162). <b>Notes:</b> <ul style="list-style-type: none"> <li>Post-magnetization is only available when ramping is the selected stop mode (see parameter <i>21.03 Stop mode</i>).</li> </ul> </td> </tr> <tr> <td>2</td> <td>DC brake</td> <td>1 = Enable DC brake.</td> </tr> <tr> <td>3...15</td> <td>Reserved</td> <td></td> </tr> </tbody> </table>	Bit	Name	Value	0	DC hold	1 = Enable DC hold. See section <i>DC hold</i> (page 162). <b>Note:</b> The DC hold function has no effect if the start signal is switched off.	1	Post-magnetization	1 = Enable post-magnetization. See section <i>Settings and diagnostics</i> (page 162). <b>Notes:</b> <ul style="list-style-type: none"> <li>Post-magnetization is only available when ramping is the selected stop mode (see parameter <i>21.03 Stop mode</i>).</li> </ul>	2	DC brake	1 = Enable DC brake.	3...15	Reserved		
Bit	Name	Value																
0	DC hold	1 = Enable DC hold. See section <i>DC hold</i> (page 162). <b>Note:</b> The DC hold function has no effect if the start signal is switched off.																
1	Post-magnetization	1 = Enable post-magnetization. See section <i>Settings and diagnostics</i> (page 162). <b>Notes:</b> <ul style="list-style-type: none"> <li>Post-magnetization is only available when ramping is the selected stop mode (see parameter <i>21.03 Stop mode</i>).</li> </ul>																
2	DC brake	1 = Enable DC brake.																
3...15	Reserved																	
	0000b...0011b	DC magnetization selection.	1 = 1															
21.09	<i>DC hold speed</i>	Defines the DC hold speed in speed control mode. See parameter <i>21.08 DC current control</i> , and section <i>DC hold</i> (page 162).	5.00 rpm															
	0.00...1000.00 rpm	DC hold speed.	See par. <i>46.01</i>															
21.10	<i>DC current reference</i>	Defines the DC hold current in percent of the motor nominal current. See parameter <i>21.08 DC current control</i> , and section <i>DC magnetization</i> (page 161). After 100 seconds post-magnetization time, the maximum magnetization current is limited to the magnetization current corresponding to the actual flux reference.	30.0%															
	0.0...100.0%	DC hold current.	1 = 1%															
21.11	<i>Post magnetization time</i>	Defines the length of time for which post-magnetization is active after stopping the motor. The magnetization current is defined by parameter <i>21.10 DC current reference</i> . See parameter <i>21.08 DC current control</i> .	0 s															
	0...3000 s	Post-magnetization time.	1 = 1 s															
21.14	<i>Pre-heating input source</i>	Selects the source for controlling pre-heating for the motor. The status of the pre-heating is shown as bit 2 of <i>06.21 Drive status word 3</i> . <b>Notes:</b> <ul style="list-style-type: none"> <li>The heating function requires that STO is not triggered.</li> <li>The heating function requires that the drive is not faulted.</li> </ul>	<i>Off</i>															
	Off	0. Pre-heating is always deactivated.	0															
	On	1. Pre-heating is always activated when the drive is stopped.	1															
	DI1	Digital input DI1 ( <i>10.02 DI delayed status</i> , bit 0).	2															
	DI2	Digital input DI2 ( <i>10.02 DI delayed status</i> , bit 1).	3															
	DI3	Digital input DI3 ( <i>10.02 DI delayed status</i> , bit 2).	4															
	DI4	Digital input DI4 ( <i>10.02 DI delayed status</i> , bit 3).	5															

No.	Name/Value	Description	Def/FbEq16
	DI5	Digital input DI5 ( <i>10.02 DI delayed status</i> , bit 4).	6
	DI6	Digital input DI6 ( <i>10.02 DI delayed status</i> , bit 5).	7
	Supervision 1	Bit 0 of <i>32.01 Supervision status</i> (see page 319).	8
	Supervision 2	Bit 1 of <i>32.01 Supervision status</i> (see page 319).	9
	Supervision 3	Bit 2 of <i>32.01 Supervision status</i> (see page 319).	10
	Timed function 1	Bit 0 of <i>34.01 Timed functions status</i> (see page 327).	11
	Timed function 2	Bit 1 of <i>34.01 Timed functions status</i> (see page 327).	12
	Timed function 3	Bit 2 of <i>34.01 Timed functions status</i> (see page 327).	13
	MCW user bit 0	Bit 12 of <i>06.01 Main control word</i> (see page 208).	16
	MCW user bit 1	Bit 13 of <i>06.01 Main control word</i> (see page 208).	17
	MCW user bit 2	Bit 14 of <i>06.01 Main control word</i> (see page 208).	18
	MCW user bit 3	Bit 15 of <i>06.01 Main control word</i> (see page 208).	19
	<i>Other [bit]</i>	Source selection (see <i>Terms and abbreviations</i> on page 196).	-
<i>21.15</i>	<i>Pre-heating time delay</i>	Defines the time delay before pre-heating starts after the drive is stopped.	60 s
	10...3000 s	Pre-heating time delay.	1 = 1 s
<i>21.16</i>	<i>Pre-heating current</i>	Defines the DC current used to heat the motor. The value is in percent of the nominal motor current.	0.0%
	0.0...30.0%	Pre-heating current.	1 = 1%
<i>21.18</i>	<i>Auto restart time</i>	<p>The motor can be automatically started after a short supply power failure using the automatic restart function. See section <i>Automatic restart</i> (page 171).</p> <p>When this parameter is set to 0.0 seconds, automatic restarting is disabled. Otherwise, the parameter defines the maximum duration of the power failure after which restarting is attempted. Note that this time also includes the DC precharging delay. See also parameter <i>21.34 Force auto restart</i>.</p> <p>This parameter has effect only if parameter <i>95.04 Control board supply</i> is set to <i>External 24V</i>.</p> <p> <b>WARNING!</b> Before you activate the function, make sure that no dangerous situations can occur. The function restarts the drive automatically and continues operation after a supply break.</p>	10.0 s
	0.0 s	Automatic restarting disabled.	0
	0.1...10.0 s	Maximum power failure duration.	1 = 1 s
<i>21.19</i>	<i>Scalar start mode</i>	<p>Selects the motor start function for the scalar motor control mode, that is, when <i>99.04 Motor control mode</i> is set to <i>Scalar</i>.</p> <p><b>Notes:</b></p> <ul style="list-style-type: none"> <li>• The start function for the vector motor control mode is selected by parameter <i>21.01 Start mode</i>.</li> <li>• With permanent magnet motors, <i>Automatic</i> start mode must be used.</li> <li>• This parameter cannot be changed while the drive is running.</li> </ul> <p>See also section <i>DC magnetization</i> (page 161).</p>	<i>Normal</i>
	Normal	Immediate start from zero speed.	0

No.	Name/Value	Description	Def/FbEq16
	Const time	<p>The drive pre-magnetizes the motor before start. The pre-magnetizing time is defined by parameter <a href="#">21.02 Magnetization time</a>. This mode should be selected if constant pre-magnetizing time is required (for example, if the motor start must be synchronized with the release of a mechanical brake). This setting also guarantees the highest possible break-away torque when the pre-magnetizing time is set long enough.</p> <p><b>Note:</b> This mode cannot be used to start into a rotating motor.</p> <p> <b>WARNING!</b> The drive will start after the set pre-magnetizing time has passed even if motor magnetization is not completed. In applications where a full break-away torque is essential, ensure that the constant magnetizing time is long enough to allow generation of full magnetization and torque.</p>	1
	Automatic	<p>The drive automatically selects the correct output frequency to start a rotating motor. This is useful for flying starts: if the motor is already rotating, the drive will start smoothly at the current frequency.</p> <p><b>Note:</b> Cannot be used in multimotor systems.</p>	2
	Torque boost	<p>The drive pre-magnetizes the motor before the start. The pre-magnetizing time is defined by parameter <a href="#">21.02 Magnetization time</a>.</p> <p>Torque boost is applied at start. Torque boost is stopped when output frequency exceeds 40% of nominal frequency or when it is equal to the reference value. See parameter <a href="#">21.26 Torque boost current</a>.</p> <p>This mode should be selected if a high break-away torque is required.</p> <p><b>Note:</b> This mode cannot be used to start into a rotating motor.</p> <p> <b>WARNING!</b> The drive will start after the set pre-magnetizing time has passed even if motor magnetization is not completed. In applications where a full break-away torque is essential, ensure that the constant magnetizing time is long enough to allow generation of full magnetization and torque.</p>	3
	Automatic+boost	<p>Automatic start with torque boost.</p> <p>Automatic start is performed first and the motor is magnetized. If the speed is found to be zero, torque boost is applied.</p>	4
	Flying start	<p>The drive automatically selects the correct output frequency to start a rotating motor. If the motor is already rotating, drive will start smoothly at the current frequency. – The mode will start the motor with vector control and switch to scalar control on the fly when the motor speed has been found.</p> <p>Compared to the Automatic start mode, Flying start detects the motor speed faster. Flying start requires more accurate information about motor model. Therefore standstill ID run is done automatically when the drive is started for the first time after selecting Flying start. Motor plate values should be accurate. Wrong plate values may decrease the starting performance.</p> <p><b>Note:</b> During flying start, the drive will at first run in vector control mode. This is why, when using flying start, the drive nominal current setting must be in the allowed range for vector control mode, see parameter <a href="#">99.06 Motor nominal current</a>.</p>	5

## 264 Parameters

No.	Name/Value	Description	Def/FbEq16
	Flying start+boost	Flying start with torque boost. Flying start is performed first and the motor is magnetized. If the speed is found to be zero, torque boost is applied.	6
21.21	<i>DC hold frequency</i>	Defines the DC hold frequency, which is used instead of parameter <i>21.09 DC hold speed</i> when the motor is in scalar frequency mode. See parameter <i>21.08 DC current control</i> , and section <i>DC hold</i> (page 162).	5.00 Hz
	0.00...1000.00 Hz	DC hold frequency.	1 = 1 Hz
21.22	<i>Start delay</i>	Defines the start delay. After the conditions for start have been fulfilled, the drive waits until the delay has elapsed and then starts the motor. During the delay, warning <i>AFE9 Start delay</i> is shown. Start delay can be used with all start modes.	0.00 s
	0.00...60.00 s	Start delay	1 = 1 s
21.23	<i>Smooth start</i>	Selects the forced current vector rotation mode at low speeds. When the smooth start mode is selected, the rate of acceleration is limited by the acceleration and deceleration ramp times. If the process driven by the permanent magnet synchronous motor has high inertia, slow ramp times are recommended. Can be used for permanent magnet synchronous motors only.	<i>Disabled</i>
	Disabled	Disabled.	0
	Enabled always	Enabled always.	1
	Start only	Enabled when starting the motor.	2
21.24	<i>Smooth start current</i>	Current used in the current vector rotation at low speeds. Increase the smooth start current if the application requires motor shaft swinging needs to be minimized. Note that accurate torque control is not possible in the current vector rotation mode. Can be used for permanent magnet synchronous motors only.	50.0%
	10.0...200.0%	Value in percent of the nominal motor current.	1 = 1%
21.25	<i>Smooth start speed</i>	Output frequency up to which the current vector rotation is used. See parameter <i>21.19 Scalar start mode</i> . Can be used for permanent magnet synchronous motors only.	10.0%
	2.0...100.0%	Value as a percentage of the nominal motor frequency.	1 = 1%
21.26	<i>Torque boost current</i>	Defines the maximum supplied current to motor when ( <i>21.19 Scalar start mode</i> is set to <i>Torque boost</i> (see page 263). Parameter value is in percent of the motor nominal current. Nominal value of the parameter is 100.0%. Torque boost is only applied at start, ending when output frequency exceeds 40% of nominal frequency or when output frequency is equal to reference. Can be used in scalar motor control mode only.	100.0%
	15.0...300.0%	Value in percent of the nominal motor current.	1 = 1%



No.	Name/Value	Description	Def/FbEq16
21.27	<i>Torque boost time</i>	Defines the minimum and maximum torque boost time. If torque boost time is less than 40% of frequency acceleration time (see parameters 28.72 and 28.74), then torque boost time is set at 40% of frequency acceleration time.	20.0 s
	0.0...60.0 s	Nominal motor time.	1 = 1 s
21.30	<i>Speed compensated stop mode</i>	Selects the method used to stop the drive. See also section. <i>Speed compensated stop</i> (page 168). Speed compensated stop is active only if <ul style="list-style-type: none"> <li>the operation mode is not torque, and <ul style="list-style-type: none"> <li>parameter 21.03 <i>Stop mode</i> is <i>Ramp</i>, or</li> <li>parameter 20.11 <i>Run enable stop mode</i> is <i>Ramp</i> (in case Run enable is missing).</li> </ul> </li> </ul>	<i>Off</i>
	Off	Stop according parameter 21.03 <i>Stop mode</i> , no speed compensated stop.	0
	Speed comp FWD	If the direction of rotation is forward, speed compensation is used for constant distance braking. Speed difference (between used speed and maximum speed) is compensated by running the drive with current speed before the motor is stopped along a ramp. If the direction of rotation is reverse, the drive is stopped along a ramp.	1
	Speed comp REV	If the direction of rotation is reverse, speed compensation is used for constant distance braking. Speed difference (between used speed and maximum speed) is compensated by running the drive with current speed before the motor is stopped along a ramp. If the direction of rotation is forward, the drive is stopped along a ramp.	2
	Speed comp bipolar	Regardless of the direction of rotation, speed compensation is used for constant distance braking. Speed difference (between used speed and maximum speed) is compensated by running the drive with current speed before the motor is stopped along a ramp.	3
21.31	<i>Speed comp stop delay</i>	This delay adds distance to the total distance traveled during a stop from maximum speed. It is used to adjust the distance to match requirements so that the distance traveled is not solely determined by the deceleration rate.	0.00 s
	0.00...1000.00 s	Speed delay.	1 = 1 s
21.32	<i>Speed comp stop threshold</i>	This parameter sets a speed threshold below which the Speed compensated stop feature is disabled. In this speed region, the speed compensated stop is not attempted and the drive stops as it would, using the ramp option.	10%
	0...100%	Speed threshold as a percent of the motor nominal speed.	1 = 1%
21.34	<i>Force auto restart</i>	Forces automatic restart. The parameter is applicable only if parameter 95.04 <i>Control board supply</i> is set to <i>External 24V</i> .	<i>Disable</i>
	Disable	Force auto restart disabled. Parameter 21.18 <i>Auto restart time</i> is in effect if its value is more than 0.0 s.	0
	Enable	Force auto restart enabled. Parameter 21.18 <i>Auto restart time</i> is ignored. The drive never trips on the undervoltage fault and the start signal is on forever. When the DC voltage is restored, the normal operation continues.	1
21.35	<i>Preheating power</i>	Defines the power used to heat the motor.	0.00

## 266 Parameters

No.	Name/Value	Description	Def/FbEq16
	0.00...10.00 kW	Preheating power.	100 = 1 kW
<b>21.36</b>	<b><i>Preheating unit</i></b>	Defines if preheating is specified as current or power.	<b><i>Current</i></b>
	Current		0
	Power		1
<b>22</b>	<b><i>Speed reference selection</i></b>	Speed reference selection; motor potentiometer settings. See the control chain diagrams on pages 554...559.	
<b>22.01</b>	<b><i>Speed ref unlimited</i></b>	Displays the output of the speed reference selection block. See the control chain diagram on page 555. This parameter is read-only.	-
	-30000.00... 30000.00 rpm	Value of the selected speed reference.	See par. <b>46.01</b>

No.	Name/Value	Description	Def/FbEq16
22.11	<i>Ext1 speed ref1</i>	<p>Selects EXT1 speed reference source 1.</p> <p>Two signal sources can be defined by this parameter and <a href="#">22.12 Ext1 speed ref2</a>. A mathematical function (<a href="#">22.13 Ext1 speed function</a>) applied to the two signals creates an EXT1 reference (A in the figure below).</p> <p>A digital source selected by <a href="#">19.11 Ext1/Ext2 selection</a> can be used to switch between EXT1 reference and the corresponding EXT2 reference defined by parameters <a href="#">22.18 Ext2 speed ref1</a>, <a href="#">22.19 Ext2 speed ref2</a> and <a href="#">22.20 Ext2 speed function</a> (B in the figure below).</p>	<i>Control panel (ref saved)</i>

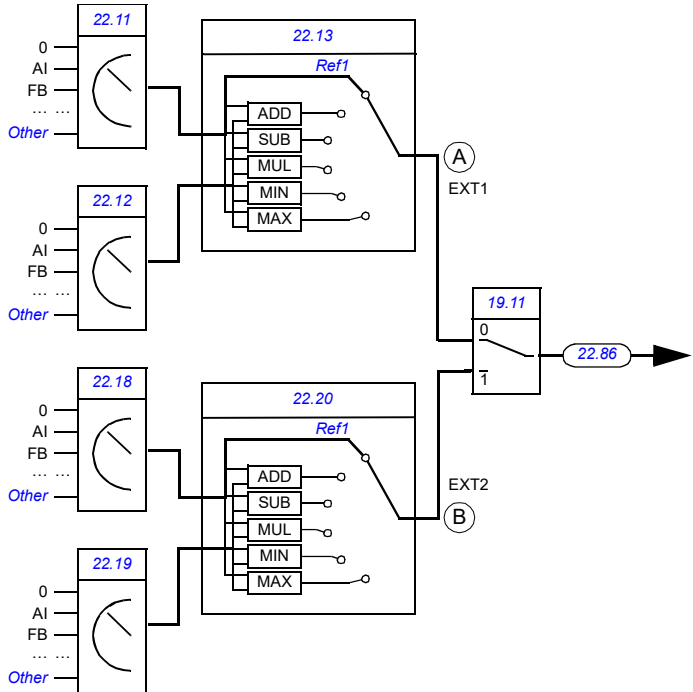

Zero	None.	0
AI1 scaled	<a href="#">12.12 AI1 scaled value</a> (see page 227).	1
AI2 scaled	<a href="#">12.22 AI2 scaled value</a> (see page 229).	2
Reserved		3
FB A ref1	<a href="#">03.05 FB A reference 1</a> (see page 202).	4
FB A ref2	<a href="#">03.06 FB A reference 2</a> (see page 202).	5
Reserved		6...7
EFB ref1	<a href="#">03.09 EFB reference 1</a> (see page 202).	8
EFB ref2	<a href="#">03.10 EFB reference 2</a> (see page 203).	9
Reserved		10...14

No.	Name/Value	Description	Def/FbEq16
	Motor potentiometer	<a href="#">22.80 Motor potentiometer ref act</a> (output of the motor potentiometer).	15
	PID	<a href="#">40.01 Process PID output actual</a> (output of the process PID controller).	16
	Frequency input	<a href="#">11.38 Freq in 1 actual value</a> (when DI5 is used as a frequency input).	17
	Control panel (ref saved)	Control panel reference ( <a href="#">03.01 Panel reference</a> , see page <a href="#">202</a> ) saved by the control system for the location where the control returns is used as the reference.  Reference 	18
	Control panel (ref copied)	Control panel reference ( <a href="#">03.01 Panel reference</a> , see page <a href="#">202</a> ) for the previous control location is used as the reference when the control location changes if the references for the two locations are of the same type (for example, frequency/speed/torque/PID); otherwise, the actual signal is used as the new reference.  Reference 	19
	<i>Other</i>	Source selection (see <a href="#">Terms and abbreviations</a> on page <a href="#">196</a> ).	-
<a href="#">22.12</a>	<a href="#">Ext1 speed ref2</a>	Selects EXT1 speed reference source 2. For the selections, and a diagram of reference source selection, see parameter <a href="#">22.11 Ext1 speed ref1</a> .	<i>Zero</i>
<a href="#">22.13</a>	<a href="#">Ext1 speed function</a>	Selects a mathematical function between the reference sources selected by parameters <a href="#">22.11 Ext1 speed ref1</a> and <a href="#">22.12 Ext1 speed ref2</a> . See diagram at <a href="#">22.11 Ext1 speed ref1</a> .	<i>Ref1</i>
	Ref1	Signal selected by <a href="#">22.11 Ext1 speed ref1</a> is used as speed reference 1 as such (no function applied).	0
	Add (ref1 + ref2)	The sum of the reference sources is used as speed reference 1.	1
	Sub (ref1 - ref2)	The subtraction ( <a href="#">[22.11 Ext1 speed ref1]</a> - <a href="#">[22.12 Ext1 speed ref2]</a> ) of the reference sources is used as speed reference 1.	2
	Mul (ref1 × ref2)	The multiplication of the reference sources is used as speed reference 1.	3
	Min (ref1, ref2)	The smaller of the reference sources is used as speed reference 1.	4
	Max (ref1, ref2)	The greater of the reference sources is used as speed reference 1.	5

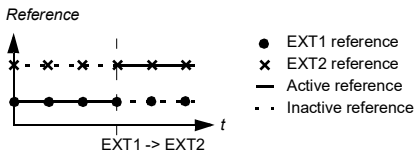
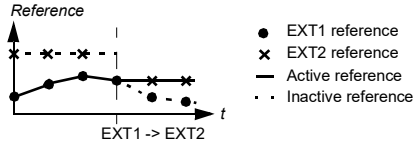
No.	Name/Value	Description	Def/FbEq16
22.18	<i>Ext2 speed ref1</i>	Selects EXT2 speed reference source 1. Two signal sources can be defined by this parameter and <a href="#">22.19 Ext2 speed ref2</a> . A mathematical function ( <a href="#">22.20 Ext2 speed function</a> ) applied to the two signals creates an EXT2 reference. See diagram at <a href="#">28.11 Ext1 frequency ref1</a> .	Zero
	Zero	None.	0
	AI1 scaled	<a href="#">12.12 AI1 scaled value</a> (see page 227).	1
	AI2 scaled	<a href="#">12.22 AI2 scaled value</a> (see page 229).	2
	Reserved		3
	FB A ref1	<a href="#">03.05 FB A reference 1</a> (see page 202).	4
	FB A ref2	<a href="#">03.06 FB A reference 2</a> (see page 202).	5
	Reserved		6...7
	EFB ref1	<a href="#">03.09 EFB reference 1</a> (see page 202).	8
	EFB ref2	<a href="#">03.10 EFB reference 2</a> (see page 203).	9
	Reserved		10...14
	Motor potentiometer	<a href="#">22.80 Motor potentiometer ref act</a> (output of the motor potentiometer).	15
	PID	<a href="#">40.01 Process PID output actual</a> (output of the process PID controller).	16
	Frequency input	<a href="#">11.38 Freq in 1 actual value</a> (when DI5 is used as a frequency input).	17
	Control panel (ref saved)	Control panel reference ( <a href="#">03.01 Panel reference</a> , see page 202) saved by the control system for the location where the control returns is used as the reference.  	18
	Control panel (ref copied)	Control panel reference ( <a href="#">03.01 Panel reference</a> , see page 202) for the previous control location is used as the reference when the control location changes if the references for the two locations are of the same type (for example, frequency/speed/torque/PID); otherwise, the actual signal is used as the new reference.  	19
	<i>Other</i>	Source selection (see <a href="#">Terms and abbreviations</a> on page 196).	-
22.19	<i>Ext2 speed ref2</i>	Selects EXT2 speed reference source 2. For the selections, and a diagram of reference source selection, see parameter <a href="#">22.18 Ext2 speed ref1</a> .	Zero

270 Parameters

No.	Name/Value	Description	Def/FbEq16
22.20	<i>Ext2 speed function</i>	Selects a mathematical function between the reference sources selected by parameters <i>22.18 Ext2 speed ref1</i> and <i>22.19 Ext2 speed ref2</i> . See diagram at <i>22.18 Ext2 speed ref1</i> .	<i>Ref1</i>
	Ref1	Signal selected by <i>Ext2 speed ref1</i> is used as speed reference 1 as such (no function applied).	0
	Add (ref1 + ref2)	The sum of the reference sources is used as speed reference 1.	1
	Sub (ref1 - ref2)	The subtraction ( <i>[22.11 Ext1 speed ref1] - [22.12 Ext1 speed ref2]</i> ) of the reference sources is used as speed reference 1.	2
	Mul (ref1 × ref2)	The multiplication of the reference sources is used as speed reference 1.	3
	Min (ref1, ref2)	The smaller of the reference sources is used as speed reference 1.	4
	Max (ref1, ref2)	The greater of the reference sources is used as speed reference 1.	5
22.21	<i>Constant speed function</i>	Determines how constant speeds are selected, and whether the rotation direction signal is considered or not when applying a constant speed.	0001b

Bit	Name	Information
0	Constant speed mode	<p>1 = Packed: 7 constant speeds are selectable using the three sources defined by parameters <i>22.22, 22.23</i> and <i>22.24</i>.</p> <p>0 = Separate: Constant speeds 1, 2 and 3 are separately activated by the sources defined by parameters <i>22.22, 22.23</i> and <i>22.24</i> respectively. In case of conflict, the constant speed with the smaller number takes priority.</p>
1	Direction enable	<p>1 = Start dir: To determine running direction for a constant speed, the sign of the constant speed setting (parameters <i>22.26...22.32</i>) is multiplied by the direction signal (forward: +1, reverse: -1). This effectively allows the drive to have 14 (7 forward, 7 reverse) constant speeds if all values in <i>22.26...22.32</i> are positive.</p> <p> <b>WARNING:</b> If the direction signal is reverse and the active constant speed is negative, the drive will run in the forward direction.</p> <p>0 = Accord Par: The running direction for the constant speed is determined by the sign of the constant speed setting (parameters <i>22.26...22.32</i>).</p>
2...15	Reserved	

0000h...FFFFh	Constant speed configuration word.	1 = 1
---------------	------------------------------------	-------

No.	Name/Value	Description	Def/FbEq16																																				
22.22	<i>Constant speed sel1</i>	When bit 0 of parameter <i>22.21 Constant speed function</i> is 0 (Separate), selects a source that activates constant speed 1. When bit 0 of parameter <i>22.21 Constant speed function</i> is 1 (Packed), this parameter and parameters <i>22.23 Constant speed sel2</i> and <i>22.24 Constant speed sel3</i> select three sources whose states activate constant speeds as follows:	<i>DI3</i>																																				
<table border="1"> <thead> <tr> <th>Source defined by par. 22.22</th> <th>Source defined by par. 22.23</th> <th>Source defined by par. 22.24</th> <th>Constant speed active</th> </tr> </thead> <tbody> <tr> <td>0</td> <td>0</td> <td>0</td> <td>None</td> </tr> <tr> <td>1</td> <td>0</td> <td>0</td> <td>Constant speed 1</td> </tr> <tr> <td>0</td> <td>1</td> <td>0</td> <td>Constant speed 2</td> </tr> <tr> <td>1</td> <td>1</td> <td>0</td> <td>Constant speed 3</td> </tr> <tr> <td>0</td> <td>0</td> <td>1</td> <td>Constant speed 4</td> </tr> <tr> <td>1</td> <td>0</td> <td>1</td> <td>Constant speed 5</td> </tr> <tr> <td>0</td> <td>1</td> <td>1</td> <td>Constant speed 6</td> </tr> <tr> <td>1</td> <td>1</td> <td>1</td> <td>Constant speed 7</td> </tr> </tbody> </table>				Source defined by par. 22.22	Source defined by par. 22.23	Source defined by par. 22.24	Constant speed active	0	0	0	None	1	0	0	Constant speed 1	0	1	0	Constant speed 2	1	1	0	Constant speed 3	0	0	1	Constant speed 4	1	0	1	Constant speed 5	0	1	1	Constant speed 6	1	1	1	Constant speed 7
Source defined by par. 22.22	Source defined by par. 22.23	Source defined by par. 22.24	Constant speed active																																				
0	0	0	None																																				
1	0	0	Constant speed 1																																				
0	1	0	Constant speed 2																																				
1	1	0	Constant speed 3																																				
0	0	1	Constant speed 4																																				
1	0	1	Constant speed 5																																				
0	1	1	Constant speed 6																																				
1	1	1	Constant speed 7																																				
	Always off	Always off.	0																																				
	Always on	Always on.	1																																				
	DI1	Digital input DI1 ( <i>10.02 DI delayed status</i> , bit 0).	2																																				
	DI2	Digital input DI2 ( <i>10.02 DI delayed status</i> , bit 1).	3																																				
	DI3	Digital input DI3 ( <i>10.02 DI delayed status</i> , bit 2).	4																																				
	DI4	Digital input DI4 ( <i>10.02 DI delayed status</i> , bit 3).	5																																				
	DI5	Digital input DI5 ( <i>10.02 DI delayed status</i> , bit 4).	6																																				
	DI6	Digital input DI6 ( <i>10.02 DI delayed status</i> , bit 5).	7																																				
	Reserved		8...17																																				
	Timed function 1	Bit 0 of <i>34.01 Timed functions status</i> (see page 327).	18																																				
	Timed function 2	Bit 1 of <i>34.01 Timed functions status</i> (see page 327).	19																																				
	Timed function 3	Bit 2 of <i>34.01 Timed functions status</i> (see page 327).	20																																				
	Reserved		21...23																																				
	Supervision 1	Bit 0 of <i>32.01 Supervision status</i> (see page 319).	24																																				
	Supervision 2	Bit 1 of <i>32.01 Supervision status</i> (see page 319).	25																																				
	Supervision 3	Bit 2 of <i>32.01 Supervision status</i> (see page 319).	26																																				
	<i>Other [bit]</i>	Source selection (see <i>Terms and abbreviations</i> on page 196).	-																																				
22.23	<i>Constant speed sel2</i>	When bit 0 of parameter <i>22.21 Constant speed function</i> is 0 (Separate), selects a source that activates constant speed 2. When bit 0 of parameter <i>22.21 Constant speed function</i> is 1 (Packed), this parameter and parameters <i>22.22 Constant speed sel1</i> and <i>22.24 Constant speed sel3</i> select three sources that are used to activate constant speeds. See table at parameter <i>22.22 Constant speed sel1</i> . For the selections, see parameter <i>22.22 Constant speed sel1</i> .	<i>DI4</i>																																				

## 272 Parameters

No.	Name/Value	Description	Def/FbEq16
22.24	<i>Constant speed sel3</i>	When bit 0 of parameter <i>22.21 Constant speed function</i> is 0 (Separate), selects a source that activates constant speed 3. When bit 0 of parameter <i>22.21 Constant speed function</i> is 1 (Packed), this parameter and parameters <i>22.22 Constant speed sel1</i> and <i>22.23 Constant speed sel2</i> select three sources that are used to activate constant speeds. See table at parameter <i>22.22 Constant speed sel1</i> . For the selections, see parameter <i>22.22 Constant speed sel1</i> .	<i>Always off</i>
22.26	<i>Constant speed 1</i>	Defines constant speed 1 (the speed the motor will turn when constant speed 1 is selected).	300.00 rpm; 360.00 rpm ( <i>95.20 b0</i> )
	-30000.00... 30000.00 rpm	Constant speed 1.	See par. <i>46.01</i>
22.27	<i>Constant speed 2</i>	Defines constant speed 2.	600.00 rpm; 720.00 rpm ( <i>95.20 b0</i> )
	-30000.00... 30000.00 rpm	Constant speed 2.	See par. <i>46.01</i>
22.28	<i>Constant speed 3</i>	Defines constant speed 3.	900.00 rpm; 1080.00 rpm ( <i>95.20 b0</i> )
	-30000.00... 30000.00 rpm	Constant speed 3.	See par. <i>46.01</i>
22.29	<i>Constant speed 4</i>	Defines constant speed 4.	1200.00 rpm; 1440.00 rpm ( <i>95.20 b0</i> )
	-30000.00... 30000.00 rpm	Constant speed 4.	See par. <i>46.01</i>
22.30	<i>Constant speed 5</i>	Defines constant speed 5.	1500.00 rpm; 1800.00 rpm ( <i>95.20 b0</i> )
	-30000.00... 30000.00 rpm	Constant speed 5.	See par. <i>46.01</i>
22.31	<i>Constant speed 6</i>	Defines constant speed 6.	2400.00 rpm; 2880.00 rpm ( <i>95.20 b0</i> )
	-30000.00... 30000.00 rpm	Constant speed 6.	See par. <i>46.01</i>
22.32	<i>Constant speed 7</i>	Defines constant speed 7.	3000.00 rpm; 3600.00 rpm ( <i>95.20 b0</i> )
	-30000.00... 30000.00 rpm	Constant speed 7.	See par. <i>46.01</i>
22.41	<i>Speed ref safe</i>	Defines a safe speed reference value that is used with supervision functions such as <ul style="list-style-type: none"> <li><i>12.03 AI supervision function</i></li> <li><i>49.05 Communication loss action</i></li> <li><i>50.02 FBA A comm loss func.</i></li> </ul>	0.00 rpm
	-30000.00... 30000.00 rpm	Safe speed reference.	See par. <i>46.01</i>



No.	Name/Value	Description	Def/FbEq16														
22.42	<i>Jogging 1 ref</i>	Defines the speed reference for jogging function 1. For more information on jogging, see page 165.	0.00 rpm														
	-30000.00... 30000.00 rpm	Speed reference for jogging function 1.	See par. 46.01														
22.43	<i>Jogging 2 ref</i>	Defines the speed reference for jogging function 2. For more information on jogging, see page 165.	0.00 rpm														
	-30000.00... 30000.00 rpm	Speed reference for jogging function 2.	See par. 46.01														
22.51	<i>Critical speed function</i>	Enables/disables the critical speeds function. Also determines whether the specified ranges are effective in both rotating directions or not. See also section <i>Critical speeds/frequencies</i> (page 125).	0000b														
<table border="1"> <thead> <tr> <th>Bit</th> <th>Name</th> <th>Information</th> </tr> </thead> <tbody> <tr> <td rowspan="2">0</td> <td rowspan="2">Enable</td> <td>1 = Enable: Critical speeds enabled.</td> </tr> <tr> <td>0 = Disable: Critical speeds disabled.</td> </tr> <tr> <td rowspan="2">1</td> <td rowspan="2">Sign mode</td> <td>1 = Signed: The signs of parameters 22.52...22.57 are taken into account.</td> </tr> <tr> <td>0 = Absolute: Parameters 22.52...22.57 are handled as absolute values. Each range is effective in both directions of rotation.</td> </tr> <tr> <td>2...15</td> <td>Reserved</td> <td></td> </tr> </tbody> </table>				Bit	Name	Information	0	Enable	1 = Enable: Critical speeds enabled.	0 = Disable: Critical speeds disabled.	1	Sign mode	1 = Signed: The signs of parameters 22.52...22.57 are taken into account.	0 = Absolute: Parameters 22.52...22.57 are handled as absolute values. Each range is effective in both directions of rotation.	2...15	Reserved	
Bit	Name	Information															
0	Enable	1 = Enable: Critical speeds enabled.															
		0 = Disable: Critical speeds disabled.															
1	Sign mode	1 = Signed: The signs of parameters 22.52...22.57 are taken into account.															
		0 = Absolute: Parameters 22.52...22.57 are handled as absolute values. Each range is effective in both directions of rotation.															
2...15	Reserved																
	0000b...0011b	Critical speeds configuration word.	1 = 1														
22.52	<i>Critical speed 1 low</i>	Defines the low limit for critical speed range 1. <b>Note:</b> This value must be less than or equal to the value of 22.53 <i>Critical speed 1 high</i> .	0.00 rpm														
	-30000.00... 30000.00 rpm	Low limit for critical speed 1.	See par. 46.01														
22.53	<i>Critical speed 1 high</i>	Defines the high limit for critical speed range 1. <b>Note:</b> This value must be greater than or equal to the value of 22.52 <i>Critical speed 1 low</i> .	0.00 rpm														
	-30000.00... 30000.00 rpm	High limit for critical speed 1.	See par. 46.01														
22.54	<i>Critical speed 2 low</i>	Defines the low limit for critical speed range 2. <b>Note:</b> This value must be less than or equal to the value of 22.55 <i>Critical speed 2 high</i> .	0.00 rpm														
	-30000.00... 30000.00 rpm	Low limit for critical speed 2.	See par. 46.01														
22.55	<i>Critical speed 2 high</i>	Defines the high limit for critical speed range 2. <b>Note:</b> This value must be greater than or equal to the value of 22.54 <i>Critical speed 2 low</i> .	0.00 rpm														
	-30000.00... 30000.00 rpm	High limit for critical speed 2.	See par. 46.01														
22.56	<i>Critical speed 3 low</i>	Defines the low limit for critical speed range 3. <b>Note:</b> This value must be less than or equal to the value of 22.57 <i>Critical speed 3 high</i> .	0.00 rpm														
	-30000.00... 30000.00 rpm	Low limit for critical speed 3.	See par. 46.01														

## 274 Parameters

No.	Name/Value	Description	Def/FbEq16
22.57	<i>Critical speed 3 high</i>	Defines the high limit for critical speed range 3. <b>Note:</b> This value must be greater than or equal to the value of <a href="#">22.56 Critical speed 3 low</a> .	0.00 rpm
	-30000.00... 30000.00 rpm	High limit for critical speed 3.	See par. <a href="#">46.01</a>
22.71	<i>Motor potentiometer function</i>	Activates and selects the mode of the motor potentiometer. See section <a href="#">Speed compensated stop</a> (page 168).	<i>Disabled</i>
	Disabled	Motor potentiometer is disabled and its value set to 0.	0
	Enabled (init at stop /power-up)	When enabled, the motor potentiometer first adopts the value defined by parameter <a href="#">22.72 Motor potentiometer initial value</a> . The value can then be adjusted from the up and down sources defined by parameters <a href="#">22.73 Motor potentiometer up source</a> and <a href="#">22.74 Motor potentiometer down source</a> . A stop or a power cycle will reset the motor potentiometer to the initial value ( <a href="#">22.72</a> ).	1
	Enabled (resume always)	As <a href="#">Enabled (init at stop /power-up)</a> , but the motor potentiometer value is retained over a power cycle.	2
	Enabled (init to actual)	Whenever another reference source is selected, the value of the motor potentiometer follows that reference. After the source of reference returns to the motor potentiometer, its value can again be changed by the up and down sources (defined by <a href="#">22.73</a> and <a href="#">22.74</a> ).	3
22.72	<i>Motor potentiometer initial value</i>	Defines an initial value (starting point) for the motor potentiometer. See the selections of parameter <a href="#">22.71 Motor potentiometer function</a> .	0.00
	-32768.00... 32767.00	Initial value for motor potentiometer.	1 = 1
22.73	<i>Motor potentiometer up source</i>	Selects the source of motor potentiometer up signal. 0 = No change 1 = Increase motor potentiometer value. (If both the up and down sources are on, the potentiometer value will not change.) <b>Note:</b> Motor potentiometer function up/down source control speed or frequency from zero to maximum speed or frequency. The running direction can be changed with parameter <a href="#">20.04 Ext1 in2 source</a> . See the figure in section <a href="#">Motor potentiometer</a> on page 150.	<i>Not used</i>
	Not used	0.	0
	Not used	1.	1
	DI1	Digital input DI1 ( <a href="#">10.02 DI delayed status</a> , bit 0).	2
	DI2	Digital input DI2 ( <a href="#">10.02 DI delayed status</a> , bit 1).	3
	DI3	Digital input DI3 ( <a href="#">10.02 DI delayed status</a> , bit 2).	4
	DI4	Digital input DI4 ( <a href="#">10.02 DI delayed status</a> , bit 3).	5
	DI5	Digital input DI5 ( <a href="#">10.02 DI delayed status</a> , bit 4).	6
	DI6	Digital input DI6 ( <a href="#">10.02 DI delayed status</a> , bit 5).	7
	Reserved		8...17
	Timed function 1	Bit 0 of <a href="#">34.01 Timed functions status</a> (see page 327).	18
	Timed function 2	Bit 1 of <a href="#">34.01 Timed functions status</a> (see page 327).	19
	Timed function 3	Bit 2 of <a href="#">34.01 Timed functions status</a> (see page 327).	20

No.	Name/Value	Description	Def/FbEq16
	Reserved		21...23
	Supervision 1	Bit 0 of <a href="#">32.01 Supervision status</a> (see page <a href="#">319</a> ).	24
	Supervision 2	Bit 1 of <a href="#">32.01 Supervision status</a> (see page <a href="#">319</a> ).	25
	Supervision 3	Bit 2 of <a href="#">32.01 Supervision status</a> (see page <a href="#">319</a> ).	26
	<i>Other [bit]</i>	Source selection (see <a href="#">Terms and abbreviations</a> on page <a href="#">196</a> ).	-
<a href="#">22.74</a>	<a href="#">Motor potentiometer down source</a>	<p>Selects the source of motor potentiometer down signal.</p> <p>0 = No change 1 = Decrease motor potentiometer value. (If both the up and down sources are on, the potentiometer value will not change.)</p> <p><b>Note:</b> Motor potentiometer function up/down source control speed or frequency from zero to maximum speed or frequency. The running direction can be changed with parameter <a href="#">20.04 Ext1 in2 source</a>. See the figure in section <a href="#">Motor potentiometer</a> on page <a href="#">150</a>.</p> <p>For the selections, see parameter <a href="#">22.73 Motor potentiometer up source</a>.</p>	<i>Not used</i>
<a href="#">22.75</a>	<a href="#">Motor potentiometer ramp time</a>	Defines the change rate of the motor potentiometer. This parameter specifies the time required for the motor potentiometer to change from minimum ( <a href="#">22.76</a> ) to maximum ( <a href="#">22.77</a> ). The same change rate applies in both directions.	40.0 s
	0.0...3600.0 s	Motor potentiometer change time.	10 = 1 s
<a href="#">22.76</a>	<a href="#">Motor potentiometer min value</a>	Defines the minimum value of the motor potentiometer. <b>Note:</b> If vector control mode is used, value of this parameter must be changed.	-50.00
	-32768.00... 32767.00	Motor potentiometer minimum.	1 = 1
<a href="#">22.77</a>	<a href="#">Motor potentiometer max value</a>	Defines the maximum value of the motor potentiometer. <b>Note:</b> If vector control mode is used, value of this parameter must be changed.	50.00
	-32768.00... 32767.00	Motor potentiometer maximum.	1 = 1
<a href="#">22.80</a>	<a href="#">Motor potentiometer ref act</a>	The output of the motor potentiometer function. (The motor potentiometer is configured using parameters <a href="#">22.71...22.74</a> .) This parameter is read-only.	-
	-32768.00... 32767.00	Value of motor potentiometer.	1 = 1
<a href="#">22.86</a>	<a href="#">Speed reference act 6</a>	Displays the value of the speed reference (EXT1 or EXT2) that has been selected by <a href="#">19.11 Ext1/Ext2 selection</a> . See diagram at <a href="#">22.11 Ext1 speed ref1</a> or the control chain diagram on page <a href="#">554</a> . This parameter is read-only.	-
	-30000.00... 30000.00 rpm	Speed reference after additive 2.	See par. <a href="#">46.01</a>

## 276 Parameters

No.	Name/Value	Description	Def/FbEq16
22.87	<i>Speed reference act 7</i>	Displays the value of speed reference before application of critical speeds. See the control chain diagram on page 555. The value is received from <a href="#">22.86 Speed reference act 6</a> unless overridden by <ul style="list-style-type: none"> <li>any constant speed</li> <li>a jogging reference</li> <li><i>network control</i> reference</li> <li>control panel reference</li> <li>safe speed reference.</li> </ul> This parameter is read-only.	-
	-30000.00... 30000.00 rpm	Speed reference before application of critical speeds.	See par. <a href="#">46.01</a>
<b>23 Speed reference ramp</b>		Speed reference ramp settings (programming of the acceleration and deceleration rates for the drive). See the control chain diagram on page 556.	
23.01	<i>Speed ref ramp input</i>	Displays the used speed reference (in rpm) before it enters the ramping and shaping functions. See the control chain diagram on page 556. This parameter is read-only.	-
	-30000.00... 30000.00 rpm	Speed reference before ramping and shaping.	See par. <a href="#">46.01</a>
23.02	<i>Speed ref ramp output</i>	Displays the ramped and shaped speed reference in rpm. See the control chain diagram on page 556. This parameter is read-only.	-
	-30000.00... 30000.00 rpm	Speed reference after ramping and shaping.	See par. <a href="#">46.01</a>
23.11	<i>Ramp set selection</i>	Selects the source that switches between the two sets of acceleration/deceleration ramp times defined by parameters <a href="#">23.12...23.15</a> . 0 = Acceleration time 1 and deceleration time 1 are active 1 = Acceleration time 2 and deceleration time 2 are active	<a href="#">DI5</a>
	Acc/Dec time 1	0.	0
	Acc/Dec time 2	1.	1
	DI1	Digital input DI1 ( <a href="#">10.02 DI delayed status</a> , bit 0).	2
	DI2	Digital input DI2 ( <a href="#">10.02 DI delayed status</a> , bit 1).	3
	DI3	Digital input DI3 ( <a href="#">10.02 DI delayed status</a> , bit 2).	4
	DI4	Digital input DI4 ( <a href="#">10.02 DI delayed status</a> , bit 3).	5
	DI5	Digital input DI5 ( <a href="#">10.02 DI delayed status</a> , bit 4).	6
	DI6	Digital input DI6 ( <a href="#">10.02 DI delayed status</a> , bit 5).	7
	Reserved		8...17
	FBA A	For Transparent16 and Transparent32 profiles only. DCU control word bit 10 received through the fieldbus adapter A.	18
	Reserved		19
	EFB DCU CW bit 10	Only for the DCU profile. DCU control word bit 10 received through the embedded fieldbus interface.	20
	<i>Other [bit]</i>	Source selection (see <a href="#">Terms and abbreviations</a> on page 196).	-

No.	Name/Value	Description	Def/FbEq16
23.12	<i>Acceleration time 1</i>	Defines acceleration time 1 as the time required for the speed to change from zero to the speed defined by parameter <a href="#">46.01 Speed scaling</a> (not to parameter <a href="#">30.12 Maximum speed</a> ). If the speed reference increases faster than the set acceleration rate, the motor speed will follow the acceleration rate. If the speed reference increases slower than the set acceleration rate, the motor speed will follow the reference. If the acceleration time is set too short, the drive will automatically prolong the acceleration in order not to exceed the drive torque limits.	5.000 s
	0.000...1800.000 s	Acceleration time 1.	10 = 1 s
23.13	<i>Deceleration time 1</i>	Defines deceleration time 1 as the time required for the speed to change from the speed defined by parameter <a href="#">46.01 Speed scaling</a> (not from parameter <a href="#">30.12 Maximum speed</a> ) to zero. If the speed reference decreases slower than the set deceleration rate, the motor speed will follow the reference. If the reference changes faster than the set deceleration rate, the motor speed will follow the deceleration rate. If the deceleration rate is set too short, the drive will automatically prolong the deceleration in order not to exceed drive torque limits (or not to exceed a safe DC link voltage). If there is any doubt about the deceleration time being too short, ensure that DC overvoltage control is on (parameter <a href="#">30.30 Overvoltage control</a> ). <b>Note:</b> If a short deceleration time is needed for a high inertia application, the drive should be equipped with braking equipment such as a brake chopper and brake resistor.	5.000 s
	0.000...1800.000 s	Deceleration time 1.	10 = 1 s
23.14	<i>Acceleration time 2</i>	Defines acceleration time 2. See parameter <a href="#">23.12 Acceleration time 1</a> .	60.000 s
	0.000...1800.000 s	Acceleration time 2.	10 = 1 s
23.15	<i>Deceleration time 2</i>	Defines deceleration time 2. See parameter <a href="#">23.13 Deceleration time 1</a> .	60.000 s
	0.000...1800.000 s	Deceleration time 2.	10 = 1 s
23.20	<i>Acc time jogging</i>	Defines the acceleration time for the jogging function ie. the time required for the speed to change from zero to the speed value defined by parameter <a href="#">46.01 Speed scaling</a> . See section <a href="#">Settings and diagnostics</a> (page <a href="#">165</a> ).	60.000 s
	0.000...1800.000 s	Acceleration time for jogging.	10 = 1 s
23.21	<i>Dec time jogging</i>	Defines the deceleration time for the jogging function ie. the time required for the speed to change from the speed value defined by parameter <a href="#">46.01 Speed scaling</a> to zero. See section <a href="#">Settings and diagnostics</a> (page <a href="#">165</a> ).	60.000 s
	0.000...1800.000 s	Deceleration time for jogging.	10 = 1 s

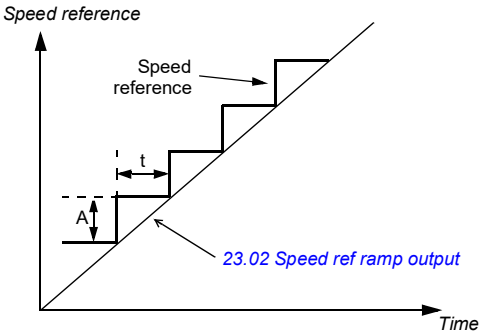
No.	Name/Value	Description	Def/FbEq16
23.23	<i>Emergency stop time</i>	<p>Defines the time inside which the drive is stopped if an emergency stop Off3 is activated (that is, the time required for the speed to change from the speed value defined by parameter <a href="#">46.01 Speed scaling</a> or <a href="#">46.02 Frequency scaling</a> to zero). Emergency stop mode and activation source are selected by parameters <a href="#">21.04 Emergency stop mode</a> and <a href="#">21.05 Emergency stop source</a> respectively. Emergency stop can also be activated through fieldbus.</p> <p><b>Note:</b></p> <ul style="list-style-type: none"> <li>Emergency stop Off1 uses the standard deceleration ramp as defined by parameters <a href="#">23.11...23.15</a>.</li> <li>The same parameter value is also used in frequency control mode (ramp parameters <a href="#">28.71...28.75</a>).</li> </ul>	3.000 s
	0.000...1800.000 s	Emergency stop Off3 deceleration time.	10 = 1 s
23.28	<i>Variable slope enable</i>	<p>Activates the variable slope function, which controls the slope of the speed ramp during a speed reference change. This allows for a constantly variable ramp rate to be generated, instead of just the standard two ramps normally available. If the update interval of the signal from an external control system and the variable slope rate (<a href="#">23.29 Variable slope rate</a>) are equal, speed reference (<a href="#">23.02 Speed ref ramp output</a>) is a straight line.</p> <p><i>Speed reference</i></p>  <p><math>t</math> = update interval of signal from an external control system  <math>A</math> = speed reference change during <math>t</math></p> <p>This function is only active in remote control.</p>	<i>Off</i>
	Off	Variable slope disabled.	0
	On	Variable slope enabled (not available in local control).	1
23.29	<i>Variable slope rate</i>	<p>Defines the rate of the speed reference change when variable slope is enabled by parameter <a href="#">23.28 Variable slope enable</a>. For the best result, enter the reference update interval into this parameter.</p>	50 ms
	2...30000 ms	Variable slope rate.	1 = 1 ms

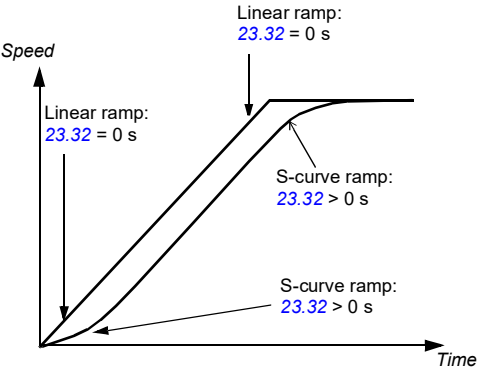
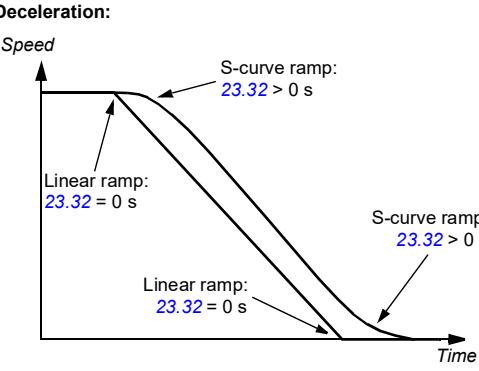
No.	Name/Value	Description	Def/FbEq16
23.32	<i>Shape time 1</i>	<p>Defines the shape of the acceleration and deceleration ramps used with the set 1.</p> <p>0.000 s: Linear ramp. Suitable for steady acceleration or deceleration and for slow ramps.</p> <p>0.001... 1000.000 s: S-curve ramp. S-curve ramps are ideal for lifting applications. The S-curve consists of symmetrical curves at both ends of the ramp and a linear part in between.</p> <p><b>Acceleration:</b></p>  <p><b>Deceleration:</b></p> 	0.000 s
	0.000...1800.000 s	Ramp shape at start and end of acceleration and deceleration.	10 = 1 s
23.33	<i>Shape time 2</i>	Defines the shape of the acceleration and deceleration ramps used with the set 2. See parameter 23.32 <i>Shape time 1</i> .	0.000 s
	0.000...1800.000 s	Ramp shape at start and end of acceleration and deceleration.	10 = 1 s

No.	Name/Value	Description	Def/FbEq16
<b>24 Speed reference conditioning</b>		Speed error calculation; speed error window control configuration; speed error step. See the control chain diagram on page 557.	
24.01	<i>Used speed reference</i>	Displays the ramped and corrected speed reference (before speed error calculation). See the control chain diagram on page 557. This parameter is read-only.	-
	-30000.00... 30000.00 rpm	Speed reference used for speed error calculation.	See par. 46.01
24.02	<i>Used speed feedback</i>	Displays the speed feedback used for speed error calculation. See the control chain diagram on page 557. This parameter is read-only.	-
	-30000.00... 30000.00 rpm	Speed feedback used for speed error calculation.	See par. 46.01
24.03	<i>Speed error filtered</i>	Displays the filtered speed error. See the control chain diagram on page 557. This parameter is read-only.	-
	-30000.0... 30000.0 rpm	Filtered speed error.	See par. 46.01
24.04	<i>Speed error inverted</i>	Displays the inverted (unfiltered) speed error. See the control chain diagram on page 557. This parameter is read-only.	-
	-30000.0... 30000.0 rpm	Inverted speed error.	See par. 46.01
24.11	<i>Speed correction</i>	Defines a speed reference correction, ie. a value added to the existing reference between ramping and limitation. This is useful to trim the speed if necessary, for example to adjust draw between sections of a paper machine. See the control chain diagram on page 557.	0.00 rpm
	-10000.00... 10000.00 rpm	Speed reference correction.	See par. 46.01
24.12	<i>Speed error filter time</i>	Defines the time constant of the speed error low-pass filter. If the used speed reference changes rapidly, the possible interferences in the speed measurement can be filtered with the speed error filter. Reducing the ripple with this filter may cause speed controller tuning problems. A long filter time constant and fast acceleration time contradict one another. A very long filter time results in unstable control.	0 ms
	0...10000 ms	Speed error filtering time constant. 0 = filtering disabled.	1 = 1 ms
<b>25 Speed control</b>		Speed controller settings. See the control chain diagram on page 557.	
25.01	<i>Torque reference speed control</i>	Displays the speed controller output that is transferred to the torque controller. See the control chain diagram on page 557. This parameter is read-only.	-
	-1600.0...1600.0%	Limited speed controller output torque.	See par. 46.03

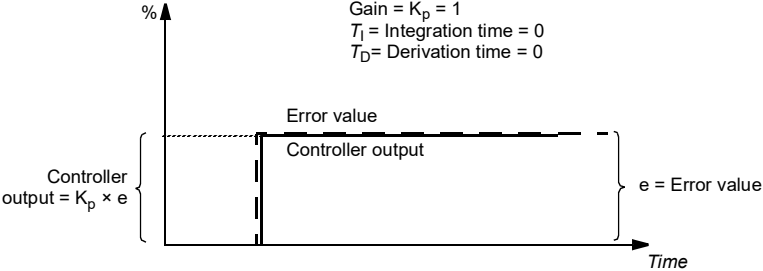

No.	Name/Value	Description	Def/FbEq16
25.02	<i>Speed proportional gain</i>	<p>Defines the proportional gain (<math>K_p</math>) of the speed controller. Too high a gain may cause speed oscillation. The figure below shows the speed controller output after an error step when the error remains constant.</p> 	5.00
0.00...250.00		<p>If gain is set to 1, a 10% change in error value (reference - actual value) causes the speed controller output to change by 10%, that is, the output value is input <math>\times</math> gain.</p>	100 = 1

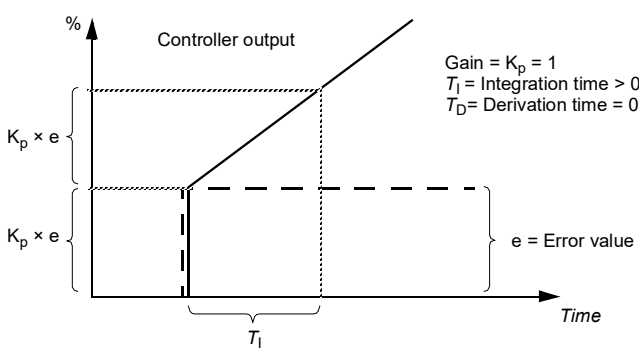
No.	Name/Value	Description	Def/FbEq16
25.03	<i>Speed integration time</i>	<p>Defines the integration time of the speed controller. The integration time defines the rate at which the controller output changes when the error value is constant and the proportional gain of the speed controller is 1. The shorter the integration time, the faster the continuous error value is corrected. This time constant must be set to the same order of magnitude as the time constant (time to respond) of the actual mechanical system being controlled, otherwise instability will result.</p> <p>Setting the integration time to zero disables the I-part of the controller. This is useful to do when tuning the proportional gain; adjust the proportional gain first, then return the integration time.</p> <p>Anti-windup (the integrator just integrates up to 100%) stops the integrator if the controller output is limited.</p> <p>The figure below shows the speed controller output after an error step when the error remains constant.</p> 	1.50 s
	0.00...1000.00 s	Integration time for speed controller.	10 = 1 s

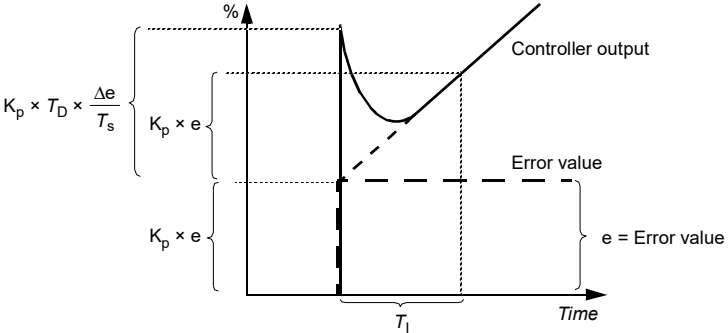
No.	Name/Value	Description	Def/FbEq16
25.04	<i>Speed derivation time</i>	<p>Defines the derivation time of the speed controller. Derivative action boosts the controller output if the error value changes. The longer the derivation time, the more the speed controller output is boosted during the change. If the derivation time is set to zero, the controller works as a PI controller, otherwise as a PID controller. The derivation makes the control more responsive for disturbances. For simple applications, derivation time is not normally required and should be left at zero.</p> <p>The speed error derivative must be filtered with a low pass filter to eliminate disturbances.</p> <p>The figure below shows the speed controller output after an error step when the error remains constant.</p>	0.000 s
		<p>Gain = <math>K_p = 1</math>  <math>T_1</math> = Integration time &gt; 0  <math>T_D</math> = Derivation time &gt; 0  <math>T_s</math> = Sample time period = 250 <math>\mu</math>s  <math>\Delta e</math> = Error value change between two samples</p>	
	0.000...10.000 s	Derivation time for speed controller.	1000 = 1 s
25.05	<i>Derivation filter time</i>	Defines the derivation filter time constant. See parameter <a href="#">25.04 Speed derivation time</a> .	8 ms
	0...10000 ms	Derivation filter time constant.	1 = 1 ms

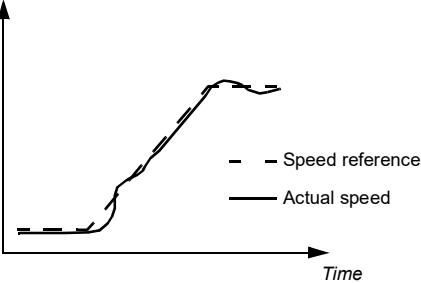
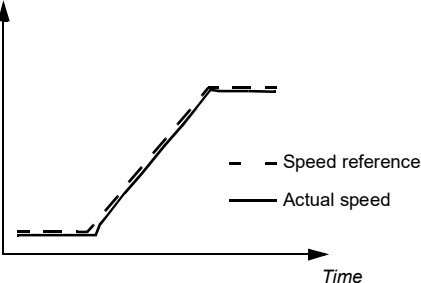
No.	Name/Value	Description	Def/FbEq16
25.06	<a href="#">Acc comp derivation time</a>	<p>Defines the derivation time for acceleration(/deceleration) compensation. In order to compensate for a high inertia load during acceleration, a derivative of the reference is added to the output of the speed controller. The principle of a derivative action is described under parameter <a href="#">25.04 Speed derivation time</a>.</p> <p><b>Note:</b> As a general rule, set this parameter to the value between 50 and 100% of the sum of the mechanical time constants of the motor and the driven machine.</p> <p>The figure below shows the speed responses when a high inertia load is accelerated along a ramp.</p> <p><b>No acceleration compensation:</b></p>  <p><b>Acceleration compensation:</b></p> 	0.00 s
	0.00...1000.00 s	Acceleration compensation derivation time.	10 = 1 s
25.07	<a href="#">Acc comp filter time</a>	Defines the acceleration (or deceleration) compensation filter time constant. See parameters <a href="#">25.04 Speed derivation time</a> and <a href="#">25.06 Acc comp derivation time</a> .	8.00 ms
	0.0...1000.0 ms	Acceleration/deceleration compensation filter time.	1 = 1 ms
25.15	<a href="#">Proportional gain em stop</a>	Defines the proportional gain for the speed controller when an emergency stop is active. See parameter <a href="#">25.02 Speed proportional gain</a> .	10.00
	1.00...250.00	Proportional gain upon an emergency stop.	100 = 1

No.	Name/Value	Description	Def/FbEq16
25.33	<i>Speed controller autotune</i>	<p>Activates (or selects a source that activates) the speed controller autotune function. See section <i>Speed controller autotune</i> (page 126).</p> <p>The autotune will automatically set parameters <i>25.02 Speed proportional gain</i>, <i>25.03 Speed integration time</i> and <i>25.37 Mechanical time constant</i>.</p> <p>The prerequisites for performing the autotune routine are:</p> <ul style="list-style-type: none"> <li>the motor identification run (ID run) has been successfully completed</li> <li>the speed and torque limits (parameter group <i>30 Limits</i>) have been set</li> <li>speed error filtering (<i>24 Speed reference conditioning</i>) and zero speed (<i>21 Start/stop mode</i>) have been set, and</li> <li>the drive has been started and is running in speed control mode.</li> </ul> <p> <b>WARNING:</b> The motor and machinery will run against the torque and speed limits during the autotune routine. MAKE SURE IT IS SAFE TO ACTIVATE THE AUTOTUNE FUNCTION!</p> <p>The autotune routine can be aborted by stopping the drive. 0-&gt;1 = Activate speed controller autotune</p> <p><b>Note:</b> The value does not revert to 0 automatically.</p>	<i>Off</i>
	Off	0	0
	On	1	1
25.34	<i>Speed controller autotune mode</i>	Defines a control preset for the speed controller autotune function. The setting affects the way the torque reference will respond to a speed reference step.	<i>Normal</i>
	Smooth	Slow but robust response.	0
	Normal	Medium setting.	1
	Tight	Fast response. May produce too high a gain value for some applications.	2
25.37	<i>Mechanical time constant</i>	Mechanical time constant of the drive and the machinery as determined by the speed controller autotune function. The value can be adjusted manually.	0.00
	0.00...1000.00 s	Mechanical time constant.	100 = 1 s
25.38	<i>Autotune torque step</i>	Defines an added torque value used by the autotune function. This value is scaled to motor nominal torque. Note that the torque used by the autotune function can also be limited by the torque limits (in parameter group <i>30 Limits</i> ) and nominal motor torque.	10.00%
	0.00...20.00%	Autotune torque step.	100 = 1%
25.39	<i>Autotune speed step</i>	Defines a speed value added to the initial speed for the autotune routine. The initial speed (speed used when autotune is activated) plus the value of this parameter is the calculated maximum speed used by the autotune routine. The maximum speed can also be limited by the speed limits (in parameter group <i>30 Limits</i> ) and nominal motor speed. The value is scaled to motor nominal speed. <b>Note:</b> The motor will exceed the calculated maximum speed slightly at the end of each acceleration stage.	10.00%
	0.00...20.00%	Autotune speed step.	100 = 1%

No.	Name/Value	Description	Def/FbEq16
25.40	<i>Autotune repeat times</i>	Determines how many acceleration/deceleration cycles are performed during the autotune routine. Increasing the value will improve the accuracy of the autotune function, and allow the use of smaller torque or speed step values.	5
	1...10	Repeat times	1 = 1
25.53	<i>Torque prop reference</i>	Displays the output of the proportional (P) part of the speed controller. See the control chain diagram on page 557. This parameter is read-only.	-
	-30000.0... 30000.0%	P-part output of speed controller.	See par. 46.03
25.54	<i>Torque integral reference</i>	Displays the output of the integral (I) part of the speed controller. See the control chain diagram on page 557. This parameter is read-only.	-
	-30000.0... 30000.0%	I-part output of speed controller.	See par. 46.03
25.55	<i>Torque deriv reference</i>	Displays the output of the derivative (D) part of the speed controller. See the control chain diagram on page 557. This parameter is read-only.	-
	-30000.0... 30000.0%	D-part output of speed controller.	See par. 46.03
25.56	<i>Torque acc compensation</i>	Displays the output of the acceleration compensation function. See the control chain diagram on page 557. This parameter is read-only.	-
	-30000.0... 30000.0%	Output of acceleration compensation function.	See par. 46.03
<b>26 Torque reference chain</b>		Settings for the torque reference chain. See the control chain diagrams on pages 560 and 561.	
26.01	<i>Torque reference to TC</i>	Displays the final torque reference given to the torque controller in percent. This reference is then acted upon by various final limiters, like power, torque, load etc. See the control chain diagrams on pages 560 and 561. This parameter is read-only.	-
	-1600.0...1600.0%	Torque reference for torque control in percent of motor nominal torque (99.12).	See par. 46.03
26.02	<i>Torque reference used</i>	Displays the final torque reference (in percent of motor nominal torque) given to the torque controller, and comes after frequency, voltage and torque limitation. See the control chain diagram on page 562. This parameter is read-only.	-
	-1600.0...1600.0%	Torque reference for torque control in percent of motor nominal torque (99.12).	See par. 46.03
26.08	<i>Minimum torque ref</i>	Defines the minimum torque reference. Allows for local limiting of the torque reference before it is passed on to the torque ramp controller. For absolute torque limiting, refer to parameter 30.19 <i>Minimum torque 1</i> .	-300.0%
	-1000.0...0.0%	Minimum torque reference in percent of motor nominal torque (99.12).	See par. 46.03

No.	Name/Value	Description	Def/FbEq16
26.09	<i>Maximum torque ref</i>	Defines the maximum torque reference. Allows for local limiting of the torque reference before it is passed on to the torque ramp controller. For absolute torque limiting, refer to parameter <i>30.20 Maximum torque 1</i> .	300.0%
	0.0...1000.0%	Maximum torque reference in percent of motor nominal torque ( <i>99.12</i> ).	See par. <i>46.03</i>
26.11	<i>Torque ref1 source</i>	Selects torque reference source 1. Two signal sources can be defined by this parameter and <i>26.12 Torque ref2 source</i> . A digital source selected by <i>26.14 Torque ref1/2 selection</i> can be used to switch between the two sources, or a mathematical function ( <i>26.13 Torque ref1 function</i> ) applied to the two signals to create the reference.	Zero
	Zero	None.	0
	AI1 scaled	<i>12.12 AI1 scaled value</i> (see page 227).	1
	AI2 scaled	<i>12.22 AI2 scaled value</i> (see page 229).	2
	Reserved		3
	FB A ref1	<i>03.05 FB A reference 1</i> (see page 202).	4
	FB A ref2	<i>03.06 FB A reference 2</i> (see page 202).	5
	Reserved		6...7
	EFB ref1	<i>03.09 EFB reference 1</i> (see page 202).	8
	EFB ref2	<i>03.10 EFB reference 2</i> (see page 203).	9
	Reserved		10...14
	Motor potentiometer	<i>22.80 Motor potentiometer ref act</i> (output of the motor potentiometer).	15
	PID	<i>40.01 Process PID output actual</i> (output of the process PID controller).	16
	Frequency input	<i>11.38 Freq in 1 actual value</i> (when DI5 is used as a frequency input).	17

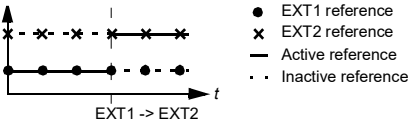
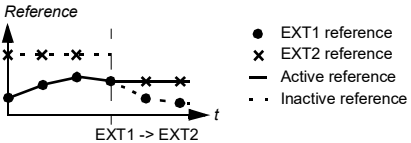
No.	Name/Value	Description	Def/FbEq16
	Control panel (ref saved)	Control panel reference ( <a href="#">03.01 Panel reference</a> , see page <a href="#">202</a> ) saved by the control system for the location where the control returns is used as the reference. <i>Reference</i> 	18
	Control panel (ref copied)	Control panel reference ( <a href="#">03.01 Panel reference</a> , see page <a href="#">202</a> ) for the previous control location is used as the reference when the control location changes if the references for the two locations are of the same type (for example, frequency/speed/torque/PID); otherwise, the actual signal is used as the new reference. <i>Reference</i> 	19
	<i>Other</i>	Source selection (see <a href="#">Terms and abbreviations</a> on page <a href="#">196</a> ).	-
26.12	<a href="#">Torque ref2 source</a>	Selects torque reference source 2. For the selections, and a diagram of reference source selection, see parameter <a href="#">26.11 Torque ref1 source</a> .	<a href="#">Zero</a>
26.13	<a href="#">Torque ref1 function</a>	Selects a mathematical function between the reference sources selected by parameters <a href="#">26.11 Torque ref1 source</a> and <a href="#">26.12 Torque ref2 source</a> . See diagram at <a href="#">26.11 Torque ref1 source</a> .	<a href="#">Ref1</a>
	Ref1	Signal selected by <a href="#">26.11 Torque ref1 source</a> is used as torque reference 1 as such (no function applied).	0
	Add (ref1 + ref2)	The sum of the reference sources is used as torque reference 1.	1
	Sub (ref1 - ref2)	The subtraction ( <a href="#">[26.11 Torque ref1 source]</a> - <a href="#">[26.12 Torque ref2 source]</a> ) of the reference sources is used as torque reference 1.	2
	Mul (ref1 × ref2)	The multiplication of the reference sources is used as torque reference 1.	3
	Min (ref1, ref2)	The smaller of the reference sources is used as torque reference 1.	4
	Max (ref1, ref2)	The greater of the reference sources is used as torque reference 1.	5
26.14	<a href="#">Torque ref1/2 selection</a>	Configures the selection between torque references 1 and 2. See diagram at <a href="#">26.11 Torque ref1 source</a> . 0 = Torque reference 1 1 = Torque reference 2	<a href="#">Torque reference 1</a>
	Torque reference 1	0.	0
	Torque reference 2	1.	1



No.	Name/Value	Description	Def/FbEq16
	Follow Ext1/Ext2 selection	Torque reference 1 is used when external control location EXT1 is active. Torque reference 2 is used when external control location EXT2 is active. See also parameter <a href="#">19.11 Ext1/Ext2 selection</a> .	2
	DI1	Digital input DI1 ( <a href="#">10.02 DI delayed status</a> , bit 0).	3
	DI2	Digital input DI2 ( <a href="#">10.02 DI delayed status</a> , bit 1).	4
	DI3	Digital input DI3 ( <a href="#">10.02 DI delayed status</a> , bit 2).	5
	DI4	Digital input DI4 ( <a href="#">10.02 DI delayed status</a> , bit 3).	6
	DI5	Digital input DI5 ( <a href="#">10.02 DI delayed status</a> , bit 4).	7
	DI6	Digital input DI6 ( <a href="#">10.02 DI delayed status</a> , bit 5).	8
	<i>Other [bit]</i>	Source selection (see <a href="#">Terms and abbreviations</a> on page 196).	-
<a href="#">26.17</a>	<a href="#">Torque ref filter time</a>	Defines a low-pass filter time constant for the torque reference.	0.000 s
	0.000...30.000 s	Filter time constant for torque reference.	1000 = 1 s
<a href="#">26.18</a>	<a href="#">Torque ramp up time</a>	Defines the torque reference ramp-up time, that is, the time for the reference to increase from zero to nominal motor torque.	0.000 s
	0.000...60.000 s	Torque reference ramp-up time.	100 = 1 s
<a href="#">26.19</a>	<a href="#">Torque ramp down time</a>	Defines the torque reference ramp-down time, that is, the time for the reference to decrease from nominal motor torque to zero.	0.000 s
	0.000...60.000 s	Torque reference ramp-down time.	100 = 1 s
<a href="#">26.20</a>	<a href="#">Torque reversal</a>	Selects the source of torque reversal function.	<i>Always off</i>
	Always off	Torque reversal function is disabled.	0
	Always on	Torque reversal function is enabled.	1
	DI1	Digital input DI1 ( <a href="#">10.02 DI delayed status</a> , bit 0).	2
	DI2	Digital input DI2 ( <a href="#">10.02 DI delayed status</a> , bit 1).	3
	DI3	Digital input DI3 ( <a href="#">10.02 DI delayed status</a> , bit 2).	4
	DI4	Digital input DI4 ( <a href="#">10.02 DI delayed status</a> , bit 3).	5
	DI5	Digital input DI5 ( <a href="#">10.02 DI delayed status</a> , bit 4).	6
	DI6	Digital input DI6 ( <a href="#">10.02 DI delayed status</a> , bit 5).	7
	Reserved		8...17
	Timed function 1	Bit 0 of <a href="#">34.01 Timed functions status</a> (see page 327).	18
	Timed function 2	Bit 1 of <a href="#">34.01 Timed functions status</a> (see page 327).	19
	Timed function 3	Bit 2 of <a href="#">34.01 Timed functions status</a> (see page 327).	20
	Reserved		21...23
	Supervision 1	Bit 0 of <a href="#">32.01 Supervision status</a> (see page 319).	24
	Supervision 2	Bit 1 of <a href="#">32.01 Supervision status</a> (see page 319).	25
	Supervision 3	Bit 2 of <a href="#">32.01 Supervision status</a> (see page 319).	26
	<i>Other [bit]</i>	Source selection (see <a href="#">Terms and abbreviations</a> on page 196).	-
<a href="#">26.70</a>	<a href="#">Torque reference act 1</a>	Displays the value of torque reference source 1 (selected by parameter <a href="#">26.11 Torque ref1 source</a> ). See the control chain diagram on page 560. This parameter is read-only.	-

## 290 Parameters

No.	Name/Value	Description	Def/FbEq16
	-1600.0...1600.0%	Value of torque reference source 1.	See par. <a href="#">46.03</a>
<a href="#">26.71</a>	<a href="#">Torque reference act 2</a>	Displays the value of torque reference source 2 (selected by parameter <a href="#">26.12 Torque ref2 source</a> ). See the control chain diagram on page <a href="#">560</a> . This parameter is read-only.	-
	-1600.0...1600.0%	Value of torque reference source 2.	See par. <a href="#">46.03</a>
<a href="#">26.72</a>	<a href="#">Torque reference act 3</a>	Displays the torque reference after the function applied by parameter <a href="#">26.13 Torque ref1 function</a> (if any), and after selection ( <a href="#">26.14 Torque ref1/2 selection</a> ). See the control chain diagram on page <a href="#">560</a> . This parameter is read-only.	-
	-1600.0...1600.0%	Torque reference after selection.	See par. <a href="#">46.03</a>
<a href="#">26.73</a>	<a href="#">Torque reference act 4</a>	Displays the torque reference after application of reference additive 1. See the control chain diagram on page <a href="#">560</a> . This parameter is read-only.	-
	-1600.0...1600.0%	Torque reference after application of reference additive 1.	See par. <a href="#">46.03</a>
<a href="#">26.74</a>	<a href="#">Torque ref ramp out</a>	Displays the torque reference after limiting and ramping. See the control chain diagram on page <a href="#">560</a> . This parameter is read-only.	-
	-1600.0...1600.0%	Torque reference after limiting and ramping.	See par. <a href="#">46.03</a>
<a href="#">26.75</a>	<a href="#">Torque reference act 5</a>	Displays the torque reference after control mode selection. See the control chain diagram on page <a href="#">561</a> . This parameter is read-only.	-
	-1600.0...1600.0%	Torque reference after control mode selection.	See par. <a href="#">46.03</a>
<a href="#">26.76</a>	<a href="#">Torque reference act 6</a>	Displays the torque reference after torque trim. See the control chain diagram on page <a href="#">561</a> . This parameter is read-only.	-
	-1600.0...1600.0%	Torque reference after torque trim.	See par. <a href="#">46.03</a>
<a href="#">26.81</a>	<a href="#">Rush control gain</a>	Rush controller gain term. See section <a href="#">Rush control</a> (page <a href="#">165</a> ).	5.0
	0.0...10000.0	Rush controller gain.	1 = 1
<a href="#">26.82</a>	<a href="#">Rush control integration time</a>	Rush controller integration time term.	2.0
	0.0...10.0	Rush controller integration time.	1 = 1 s
<b><a href="#">28 Frequency reference chain</a></b>		Settings for the frequency reference chain. See the control chain diagrams on pages <a href="#">552</a> and <a href="#">553</a> .	
<a href="#">28.01</a>	<a href="#">Frequency ref ramp input</a>	Displays the used frequency reference before ramping. See the control chain diagram on page <a href="#">552</a> . This parameter is read-only.	-
	-500.00...500.00 Hz	Frequency reference before ramping.	See par. <a href="#">46.02</a>

No.	Name/Value	Description	Def/FbEq16
28.02	<i>Frequency ref ramp output</i>	Displays the final frequency reference (after selection, limitation and ramping). See the control chain diagram on page 552. This parameter is read-only.	-
	-500.00...500.00 Hz	Final frequency reference.	See par. 46.02
28.11	<i>Ext1 frequency ref1</i>	<p>Selects EXT1 frequency reference source 1.</p> <p>Two signal sources can be defined by this parameter and 28.12 <i>Ext1 frequency ref2</i>. A mathematical function (28.13 <i>Ext1 frequency function</i>) applied to the two signals creates an EXT1 reference (A in the figure below).</p> <p>A digital source selected by 19.11 <i>Ext1/Ext2 selection</i> can be used to switch between EXT1 reference and the corresponding EXT2 reference defined by parameters 28.15 <i>Ext2 frequency ref1</i>, 28.16 <i>Ext2 frequency ref2</i> and 28.17 <i>Ext2 frequency function</i> (B in the figure below).</p>	<i>AI1 scaled</i>
	Zero	None.	0
	AI1 scaled	12.12 <i>AI1 scaled value</i> (see page 227).	1
	AI2 scaled	12.22 <i>AI2 scaled value</i> (see page 229).	2
	Reserved		3
	FB A ref1	03.05 <i>FB A reference 1</i> (see page 202).	4
	FB A ref2	03.06 <i>FB A reference 2</i> (see page 202).	5

No.	Name/Value	Description	Def/FbEq16
	Reserved		6...7
	EFB ref1	<a href="#">03.09 EFB reference 1</a> (see page <a href="#">202</a> ).	8
	EFB ref2	<a href="#">03.10 EFB reference 2</a> (see page <a href="#">203</a> ).	9
	Reserved		10...14
	Motor potentiometer	<a href="#">22.80 Motor potentiometer ref act</a> (output of the motor potentiometer).	15
	PID	<a href="#">40.01 Process PID output actual</a> (output of the process PID controller).	16
	Frequency input	<a href="#">11.38 Freq in 1 actual value</a> (when DI5 is used as a frequency input).	17
	Control panel (ref saved)	Control panel reference ( <a href="#">03.01 Panel reference</a> , see page <a href="#">202</a> ) saved by the control system for the location where the control returns is used as the reference.  <div style="text-align: center;"> <p>Reference</p> <p>● EXT1 reference  x EXT2 reference  — Active reference  - - Inactive reference</p> <p>EXT1 -&gt; EXT2</p> </div>	18
	Control panel (ref copied)	Control panel reference ( <a href="#">03.01 Panel reference</a> , see page <a href="#">202</a> ) for the previous control location is used as the reference when the control location changes if the references for the two locations are of the same type (for example, frequency/speed/torque/PID); otherwise, the actual signal is used as the new reference.  <div style="text-align: center;"> <p>Reference</p> <p>● EXT1 reference  x EXT2 reference  — Active reference  - - Inactive reference</p> <p>EXT1 -&gt; EXT2</p> </div>	19
	<i>Other</i>	Source selection (see <a href="#">Terms and abbreviations</a> on page <a href="#">196</a> ).	-
<a href="#">28.12</a>	<a href="#">Ext1 frequency ref2</a>	Selects EXT1 frequency reference source 2. For the selections, and a diagram of reference source selection, see parameter <a href="#">28.11 Ext1 frequency ref1</a> .	<i>Zero</i>
<a href="#">28.13</a>	<a href="#">Ext1 frequency function</a>	Selects a mathematical function between the reference sources selected by parameters <a href="#">28.11 Ext1 frequency ref1</a> and <a href="#">28.12 Ext1 frequency ref2</a> . See diagram at <a href="#">28.11 Ext1 frequency ref1</a> .	<i>Ref1</i>
	Ref1	Signal selected by <a href="#">28.11 Ext1 frequency ref1</a> is used as frequency reference 1 as such (no function applied).	0
	Add (ref1 + ref2)	The sum of the reference sources is used as frequency reference 1.	1
	Sub (ref1 - ref2)	The subtraction ( <a href="#">28.11 Ext1 frequency ref1</a> - <a href="#">28.12 Ext1 frequency ref2</a> ) of the reference sources is used as frequency reference 1.	2
	Mul (ref1 × ref2)	The multiplication of the reference sources is used as frequency reference 1.	3
	Min (ref1, ref2)	The smaller of the reference sources is used as frequency reference 1.	4

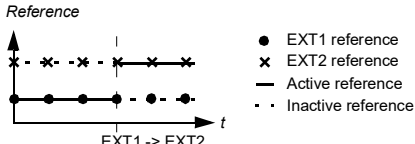
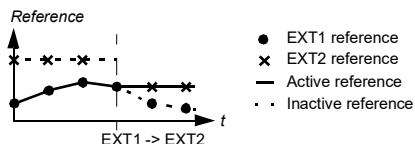
No.	Name/Value	Description	Def/FbEq16
	Max (ref1, ref2)	The greater of the reference sources is used as frequency reference 1.	5
28.15	<i>Ext2 frequency ref1</i>	Selects EXT2 frequency reference source 1. Two signal sources can be defined by this parameter and <a href="#">28.16 Ext2 frequency ref2</a> . A mathematical function ( <a href="#">28.17 Ext2 frequency function</a> ) applied to the two signals creates an EXT2 reference. See diagram at <a href="#">28.11 Ext1 frequency ref1</a> .	Zero
	Zero	None.	0
	AI1 scaled	<a href="#">12.12 AI1 scaled value</a> (see page <a href="#">227</a> ).	1
	AI2 scaled	<a href="#">12.22 AI2 scaled value</a> (see page <a href="#">229</a> ).	2
	Reserved		3
	FB A ref1	<a href="#">03.05 FB A reference 1</a> (see page <a href="#">202</a> ).	4
	FB A ref2	<a href="#">03.06 FB A reference 2</a> (see page <a href="#">202</a> ).	5
	Reserved		6...7
	EFB ref1	<a href="#">03.09 EFB reference 1</a> (see page <a href="#">202</a> ).	8
	EFB ref2	<a href="#">03.10 EFB reference 2</a> (see page <a href="#">203</a> ).	9
	Reserved		10...14
	Motor potentiometer	<a href="#">22.80 Motor potentiometer ref act</a> (output of the motor potentiometer).	15
	PID	<a href="#">40.01 Process PID output actual</a> (output of the process PID controller).	16
	Frequency input	<a href="#">11.38 Freq in 1 actual value</a> (when DI5 or DI6 is used as a frequency input).	17
	Control panel (ref saved)	Control panel reference ( <a href="#">03.01 Panel reference</a> , see page <a href="#">202</a> ) saved by the control system for the location where the control returns is used as the reference.  	18
	Control panel (ref copied)	Control panel reference ( <a href="#">03.01 Panel reference</a> , see page <a href="#">202</a> ) for the previous control location is used as the reference when the control location changes if the references for the two locations are of the same type (for example, frequency/speed/torque/PID); otherwise, the actual signal is used as the new reference.  	19
	<i>Other</i>	Source selection (see <a href="#">Terms and abbreviations</a> on page <a href="#">196</a> ).	-
28.16	<i>Ext2 frequency ref2</i>	Selects EXT2 frequency reference source 2. For the selections, and a diagram of reference source selection, see parameter <a href="#">28.15 Ext2 frequency ref1</a> .	Zero

No.	Name/Value	Description	Def/FbEq16
28.17	<i>Ext2 frequency function</i>	Selects a mathematical function between the reference sources selected by parameters <i>28.15 Ext2 frequency ref1</i> and <i>28.16 Ext2 frequency ref2</i> . See diagram at <i>28.15 Ext2 frequency ref1</i> .	<i>Ref1</i>
	Ref1	Signal selected by <i>28.15 Ext2 frequency ref1</i> is used as frequency reference 1 as such (no function applied).	0
	Add (ref1 + ref2)	The sum of the reference sources is used as frequency reference 1.	1
	Sub (ref1 - ref2)	The subtraction ( <i>[28.15 Ext2 frequency ref1] - [28.16 Ext2 frequency ref2]</i> ) of the reference sources is used as frequency reference 1.	2
	Mul (ref1 × ref2)	The multiplication of the reference sources is used as frequency reference 1.	3
	Min (ref1, ref2)	The smaller of the reference sources is used as frequency reference 1.	4
	Max (ref1, ref2)	The greater of the reference sources is used as frequency reference 1.	5
28.21	<i>Constant frequency function</i>	Determines how constant frequencies are selected, and whether the rotation direction signal is considered or not when applying a constant frequency.	0001b

Bit	Name	Information
0	Const freq mode	1 = Packed: 7 constant frequencies are selectable using the three sources defined by parameters <i>28.22</i> , <i>28.23</i> and <i>28.24</i> .
		0 = Separate: Constant frequencies 1, 2 and 3 are separately activated by the sources defined by parameters <i>28.22</i> , <i>28.23</i> and <i>28.24</i> respectively. In case of conflict, the constant frequency with the smaller number takes priority.
1	Direction enable	1 = Start dir: To determine running direction for a constant speed, the sign of the constant speed setting (parameters <i>22.26...22.32</i> ) is multiplied by the direction signal (forward: +1, reverse: -1). This effectively allows the drive to have 14 (7 forward, 7 reverse) constant speeds if all values in <i>22.26...22.32</i> are positive.   <b>WARNING:</b> If the direction signal is reverse and the active constant speed is negative, the drive will run in the forward direction.
		0 = Accord Par: The running direction for the constant speed is determined by the sign of the constant speed setting (parameters <i>22.26...22.32</i> ).
2...15	Reserved	

0000b...0011b	Constant frequency configuration word.	1 = 1
---------------	--	-------

No.	Name/Value	Description	Def/FbEq16																																				
28.22	<i>Constant frequency sel1</i>	When bit 0 of parameter <i>28.21 Constant frequency function</i> is 0 (Separate), selects a source that activates constant frequency 1. When bit 0 of parameter <i>28.21 Constant frequency function</i> is 1 (Packed), this parameter and parameters <i>28.23 Constant frequency sel2</i> and <i>28.24 Constant frequency sel3</i> select three sources whose states activate constant frequencies as follows:	<i>DI3</i>																																				
<table border="1"> <thead> <tr> <th>Source defined by par. 28.22</th> <th>Source defined by par. 28.23</th> <th>Source defined by par. 28.24</th> <th>Constant frequency active</th> </tr> </thead> <tbody> <tr> <td>0</td> <td>0</td> <td>0</td> <td>None</td> </tr> <tr> <td>1</td> <td>0</td> <td>0</td> <td>Constant frequency 1</td> </tr> <tr> <td>0</td> <td>1</td> <td>0</td> <td>Constant frequency 2</td> </tr> <tr> <td>1</td> <td>1</td> <td>0</td> <td>Constant frequency 3</td> </tr> <tr> <td>0</td> <td>0</td> <td>1</td> <td>Constant frequency 4</td> </tr> <tr> <td>1</td> <td>0</td> <td>1</td> <td>Constant frequency 5</td> </tr> <tr> <td>0</td> <td>1</td> <td>1</td> <td>Constant frequency 6</td> </tr> <tr> <td>1</td> <td>1</td> <td>1</td> <td>Constant frequency 7</td> </tr> </tbody> </table>				Source defined by par. 28.22	Source defined by par. 28.23	Source defined by par. 28.24	Constant frequency active	0	0	0	None	1	0	0	Constant frequency 1	0	1	0	Constant frequency 2	1	1	0	Constant frequency 3	0	0	1	Constant frequency 4	1	0	1	Constant frequency 5	0	1	1	Constant frequency 6	1	1	1	Constant frequency 7
Source defined by par. 28.22	Source defined by par. 28.23	Source defined by par. 28.24	Constant frequency active																																				
0	0	0	None																																				
1	0	0	Constant frequency 1																																				
0	1	0	Constant frequency 2																																				
1	1	0	Constant frequency 3																																				
0	0	1	Constant frequency 4																																				
1	0	1	Constant frequency 5																																				
0	1	1	Constant frequency 6																																				
1	1	1	Constant frequency 7																																				
	Always off	Always off.	0																																				
	Always on	Always on.	1																																				
	DI1	Digital input DI1 ( <i>10.02 DI delayed status</i> , bit 0).	2																																				
	DI2	Digital input DI2 ( <i>10.02 DI delayed status</i> , bit 1).	3																																				
	DI3	Digital input DI3 ( <i>10.02 DI delayed status</i> , bit 2).	4																																				
	DI4	Digital input DI4 ( <i>10.02 DI delayed status</i> , bit 3).	5																																				
	DI5	Digital input DI5 ( <i>10.02 DI delayed status</i> , bit 4).	6																																				
	DI6	Digital input DI6 ( <i>10.02 DI delayed status</i> , bit 5).	7																																				
	Reserved		8...17																																				
	Timed function 1	Bit 0 of <i>34.01 Timed functions status</i> (see page 327).	18																																				
	Timed function 2	Bit 1 of <i>34.01 Timed functions status</i> (see page 327).	19																																				
	Timed function 3	Bit 2 of <i>34.01 Timed functions status</i> (see page 327).	20																																				
	Reserved		21...23																																				
	Supervision 1	Bit 0 of <i>32.01 Supervision status</i> (see page 319).	24																																				
	Supervision 2	Bit 1 of <i>32.01 Supervision status</i> (see page 319).	25																																				
	Supervision 3	Bit 2 of <i>32.01 Supervision status</i> (see page 319).	26																																				
	<i>Other [bit]</i>	Source selection (see <i>Terms and abbreviations</i> on page 196).	-																																				
28.23	<i>Constant frequency sel2</i>	When bit 0 of parameter <i>28.21 Constant frequency function</i> is 0 (Separate), selects a source that activates constant frequency 2. When bit 0 of parameter <i>28.21 Constant frequency function</i> is 1 (Packed), this parameter and parameters <i>28.22 Constant frequency sel1</i> and <i>28.24 Constant frequency sel3</i> select three sources that are used to activate constant frequencies. See table at parameter <i>28.22 Constant frequency sel1</i> . For the selections, see parameter <i>28.22 Constant frequency sel1</i> .	<i>DI4</i>																																				

No.	Name/Value	Description	Def/FbEq16
28.24	<a href="#">Constant frequency sel3</a>	When bit 0 of parameter <a href="#">28.21 Constant frequency function</a> is 0 (Separate), selects a source that activates constant frequency 3. When bit 0 of parameter <a href="#">28.21 Constant frequency function</a> is 1 (Packed), this parameter and parameters <a href="#">28.22 Constant frequency sel1</a> and <a href="#">28.23 Constant frequency sel2</a> select three sources that are used to activate constant frequencies. See table at parameter <a href="#">28.22 Constant frequency sel1</a> . For the selections, see parameter <a href="#">28.22 Constant frequency sel1</a> .	<i>Always off</i>
28.26	<a href="#">Constant frequency 1</a>	Defines constant frequency 1 (the frequency the motor will turn when constant frequency 1 is selected).	5.00 Hz; 6.00 Hz ( <a href="#">95.20</a> b0)
	-500.00...500.00 Hz	Constant frequency 1.	See par. <a href="#">46.02</a>
28.27	<a href="#">Constant frequency 2</a>	Defines constant frequency 2.	10.00 Hz; 12.00 Hz ( <a href="#">95.20</a> b0)
	-500.00...500.00 Hz	Constant frequency 2.	See par. <a href="#">46.02</a>
28.28	<a href="#">Constant frequency 3</a>	Defines constant frequency 3.	15.00 Hz; 18.00 Hz ( <a href="#">95.20</a> b0)
	-500.00...500.00 Hz	Constant frequency 3.	See par. <a href="#">46.02</a>
28.29	<a href="#">Constant frequency 4</a>	Defines constant frequency 4.	20.00 Hz; 24.00 Hz ( <a href="#">95.20</a> b0)
	-500.00...500.00 Hz	Constant frequency 4.	See par. <a href="#">46.02</a>
28.30	<a href="#">Constant frequency 5</a>	Defines constant frequency 5.	25.00 Hz; 30.00 Hz ( <a href="#">95.20</a> b0)
	-500.00...500.00 Hz	Constant frequency 5.	See par. <a href="#">46.02</a>
28.31	<a href="#">Constant frequency 6</a>	Defines constant frequency 6.	40.00 Hz; 48.00 Hz ( <a href="#">95.20</a> b0)
	-500.00...500.00 Hz	Constant frequency 6.	See par. <a href="#">46.02</a>
28.32	<a href="#">Constant frequency 7</a>	Defines constant frequency 7.	50.00 Hz; 60.00 Hz ( <a href="#">95.20</a> b0)
	-500.00...500.00 Hz	Constant frequency 7.	See par. <a href="#">46.02</a>
28.41	<a href="#">Frequency ref safe</a>	Defines a safe frequency reference value that is used with supervision functions such as <ul style="list-style-type: none"> <li>• <a href="#">12.03 AI supervision function</a></li> <li>• <a href="#">49.05 Communication loss action</a></li> <li>• <a href="#">50.02 FBA A comm loss func.</a></li> </ul>	0.00 Hz
	-500.00...500.00 Hz	Safe frequency reference.	See par. <a href="#">46.02</a>





No.	Name/Value	Description	Def/FbEq16
28.57	<i>Critical frequency 3 high</i>	Defines the high limit for critical frequency 3. <b>Note:</b> This value must be greater than or equal to the value of <a href="#">28.56 Critical frequency 3 low</a> .	0.00 Hz
	-500.00...500.00 Hz	High limit for critical frequency 3.	See par. <a href="#">46.02</a>
28.71	<i>Freq ramp set selection</i>	Selects a source that switches between the two sets of acceleration/deceleration times defined by parameters <a href="#">28.72...28.75</a> . 0 = Acceleration time 1 and deceleration time 1 are in force 1 = Acceleration time 2 and deceleration time 2 are in force	<a href="#">DI5</a>
	Acc/Dec time 1	0.	0
	Acc/Dec time 2	1.	1
	DI1	Digital input DI1 ( <a href="#">10.02 DI delayed status</a> , bit 0).	2
	DI2	Digital input DI2 ( <a href="#">10.02 DI delayed status</a> , bit 1).	3
	DI3	Digital input DI3 ( <a href="#">10.02 DI delayed status</a> , bit 2).	4
	DI4	Digital input DI4 ( <a href="#">10.02 DI delayed status</a> , bit 3).	5
	DI5	Digital input DI5 ( <a href="#">10.02 DI delayed status</a> , bit 4).	6
	DI6	Digital input DI6 ( <a href="#">10.02 DI delayed status</a> , bit 5).	7
	Reserved		8...17
	FBA A	For Transparent16 and Transparent32 profiles only. DCU control word bit 10 received through the fieldbus adapter.	18
	Reserved		19
	EFB DCU CW bit 10	Only for the DCU profile. DCU control word bit 10 received through the embedded fieldbus interface.	20
	<i>Other [bit]</i>	Source selection (see <a href="#">Terms and abbreviations</a> on page <a href="#">196</a> ).	-
28.72	<i>Freq acceleration time 1</i>	Defines acceleration time 1 as the time required for the frequency to change from zero to the frequency defined by parameter <a href="#">46.02 Frequency scaling</a> . After this frequency has been reached, the acceleration continues with the same rate to the value defined by parameter <a href="#">30.14 Maximum frequency</a> . If the reference increases faster than the set acceleration rate, the motor will follow the acceleration rate. If the reference increases slower than the set acceleration rate, the motor frequency will follow the reference. If the acceleration time is set too short, the drive will automatically prolong the acceleration in order not to exceed the drive torque limits.	20.000 s
	0.000...1800.000 s	Acceleration time 1.	10 = 1 s
28.73	<i>Freq deceleration time 1</i>	Defines deceleration time 1 as the time required for the frequency to change from the frequency defined by parameter <a href="#">46.02 Frequency scaling</a> (not from parameter <a href="#">30.14 Maximum frequency</a> ) to zero. If there is any doubt about the deceleration time being too short, ensure that DC overvoltage control ( <a href="#">30.30 Overvoltage control</a> ) is on. <b>Note:</b> If a short deceleration time is needed for a high inertia application, the drive should be equipped with braking equipment such as a brake chopper and brake resistor.	20.000 s
	0.000...1800.000 s	Deceleration time 1.	10 = 1 s

No.	Name/Value	Description	Def/FbEq16
28.74	<i>Freq acceleration time 2</i>	Defines acceleration time 2. See parameter <a href="#">28.72 Freq acceleration time 1</a> .	60.000 s
	0.000...1800.000 s	Acceleration time 2.	10 = 1 s
28.75	<i>Freq deceleration time 2</i>	Defines deceleration time 2. See parameter <a href="#">28.73 Freq deceleration time 1</a> .	60.000 s
	0.000...1800.000 s	Deceleration time 2.	10 = 1 s
28.76	<i>Freq ramp in zero source</i>	Selects a source that forces the frequency reference to zero. 0 = Force frequency reference to zero 1 = Normal operation	<i>Inactive</i>
	Active	0.	0
	Inactive	1.	1
	DI1	Digital input DI1 ( <a href="#">10.02 DI delayed status</a> , bit 0).	2
	DI2	Digital input DI2 ( <a href="#">10.02 DI delayed status</a> , bit 1).	3
	DI3	Digital input DI3 ( <a href="#">10.02 DI delayed status</a> , bit 2).	4
	DI4	Digital input DI4 ( <a href="#">10.02 DI delayed status</a> , bit 3).	5
	DI5	Digital input DI5 ( <a href="#">10.02 DI delayed status</a> , bit 4).	6
	DI6	Digital input DI6 ( <a href="#">10.02 DI delayed status</a> , bit 5).	7
	<i>Other [bit]</i>	Source selection (see <a href="#">Terms and abbreviations</a> on page 196).	-

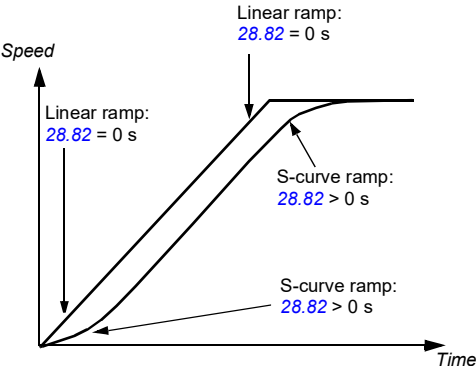
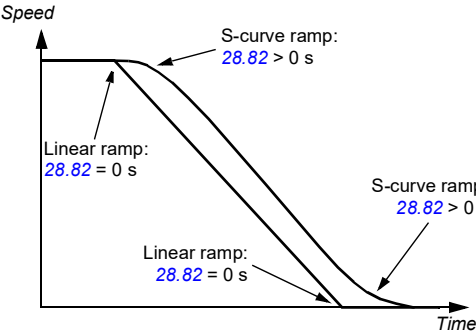

No.	Name/Value	Description	Def/FbEq16
28.82	Shape time 1	<p>Defines the shape of the acceleration and deceleration ramps used with the set 1.</p> <p>0.000 s: Linear ramp. Suitable for steady acceleration or deceleration and for slow ramps.</p> <p>0.001...1000.000 s: S-curve ramp. S-curve ramps are ideal for lifting applications. The S-curve consists of symmetrical curves at both ends of the ramp and a linear part in between.</p> <p><b>Acceleration:</b></p>  <p><b>Deceleration:</b></p> 	0.000 s
0.000...1800.000 s		Ramp shape at start and end of acceleration and deceleration.	10 = 1 s
28.83	Shape time 2	Defines the shape of the acceleration and deceleration ramps used with the set 2. See parameter 28.82 Shape time 1.	0.000 s
0.000...1800.000 s		Ramp shape at start and end of acceleration and deceleration.	10 = 1 s



No.	Name/Value	Description	Def/FbEq16
28.92	<i>Frequency ref act 3</i>	Displays the frequency reference after the function applied by parameter <a href="#">28.13 Ext1 frequency function</a> (if any), and after selection ( <a href="#">19.11 Ext1/Ext2 selection</a> ). See the control chain diagram on page 552. This parameter is read-only.	-
	-500.00...500.00 Hz	Frequency reference after selection.	See par. <a href="#">46.02</a>
28.96	<i>Frequency ref act 7</i>	Displays the frequency reference after application of constant frequencies, control panel reference, etc. See the control chain diagram on page 552. This parameter is read-only.	-
	-500.00...500.00 Hz	Frequency reference 7.	See par. <a href="#">46.02</a>
28.97	<i>Frequency ref unlimited</i>	Displays the frequency reference after application of critical frequencies, but before ramping and limiting. See the control chain diagram on page 553. This parameter is read-only.	-
	-500.00...500.00 Hz	Frequency reference before ramping and limiting.	See par. <a href="#">46.02</a>

<b>30 Limits</b>		Drive operation limits.	
30.01	<i>Limit word 1</i>	Displays limit word 1. This parameter is read-only.	-
<b>Bit</b>	<b>Name</b>	<b>Description</b>	
0	Torq lim	1 = Torque is being limited by the motor control (undervoltage control, current control, load angle control or pull-out control), or by the torque limits defined by parameters.	
1...2	Reserved		
3	Torq ref max	1 = Torque reference ramp input is being limited by <a href="#">26.09 Maximum torque ref</a> , <a href="#">30.20 Maximum torque 1</a> , <a href="#">30.26 Power motoring limit</a> or <a href="#">30.27 Power generating limit</a> . See the diagram on page 562.	
4	Torq ref min	1 = Torque reference ramp input is being limited by <a href="#">26.08 Minimum torque ref</a> , <a href="#">30.19 Minimum torque 1</a> , <a href="#">30.26 Power motoring limit</a> or <a href="#">30.27 Power generating limit</a> . See the diagram on page 562.	
5	Tlim max speed	1 = Torque reference is being limited by the rush control because of maximum speed limit ( <a href="#">30.12 Maximum speed</a> )	
6	Tlim min speed	1 = Torque reference is being limited by the rush control because of minimum speed limit ( <a href="#">30.11 Minimum speed</a> )	
7	Max speed ref lim	1 = Speed reference is being limited by <a href="#">30.12 Maximum speed</a>	
8	Min speed ref lim	1 = Speed reference is being limited by <a href="#">30.11 Minimum speed</a>	
9	Max freq ref lim	1 = Frequency reference is being limited by <a href="#">30.14 Maximum frequency</a>	
10	Min freq ref lim	1 = Frequency reference is being limited by <a href="#">30.13 Minimum frequency</a>	
11...15	Reserved		
0000h...FFFFh	Limit word 1.		1 = 1

## 302 Parameters

No.	Name/Value	Description	Def/FbEq16																																																
30.02	<i>Torque limit status</i>	Displays the torque controller limitation status word. This parameter is read-only.	-																																																
<table border="1"> <thead> <tr> <th>Bit</th> <th>Name</th> <th>Description</th> </tr> </thead> <tbody> <tr> <td>0</td> <td>Undervoltage</td> <td>*1 = Intermediate DC circuit undervoltage</td> </tr> <tr> <td>1</td> <td>Overvoltage</td> <td>*1 = Intermediate DC circuit overvoltage</td> </tr> <tr> <td>2</td> <td>Minimum torque</td> <td>*1 = Torque is being limited by <a href="#">30.19 Minimum torque 1</a>, <a href="#">30.26 Power motoring limit</a> or <a href="#">30.27 Power generating limit</a></td> </tr> <tr> <td>3</td> <td>Maximum torque</td> <td>*1 = Torque is being limited by <a href="#">30.20 Maximum torque 1</a>, <a href="#">30.26 Power motoring limit</a> or <a href="#">30.27 Power generating limit</a></td> </tr> <tr> <td>4</td> <td>Internal current</td> <td>1 = An inverter current limit (identified by bits 8...11) is active</td> </tr> <tr> <td>5</td> <td>Load angle</td> <td>(With permanent magnet motors and reluctance motors only) 1 = Load angle limit is active, ie. the motor cannot produce any more torque</td> </tr> <tr> <td>6</td> <td>Motor pullout</td> <td>(With asynchronous motors only) Motor pull-out limit is active, ie. the motor cannot produce any more torque</td> </tr> <tr> <td>7</td> <td>Reserved</td> <td></td> </tr> <tr> <td>8</td> <td>Thermal</td> <td>1 = Input current is being limited by the main circuit thermal limit</td> </tr> <tr> <td>9</td> <td>Max current</td> <td>*1 = Maximum output current (<math>I_{MAX}</math>) is being limited</td> </tr> <tr> <td>10</td> <td>User current</td> <td>*1 = Output current is being limited by <a href="#">30.17 Maximum current</a></td> </tr> <tr> <td>11</td> <td>Thermal IGBT</td> <td>*1 = Output current is being limited by a calculated thermal current value</td> </tr> <tr> <td>12</td> <td>IGBT overtemperature</td> <td>*1 = Output current is being limited because of estimated IGBT temperature</td> </tr> <tr> <td>13</td> <td>IGBT overload</td> <td>*1 = Output current is being limited because of IGBT junction to case temperature</td> </tr> <tr> <td>14...15</td> <td>Reserved</td> <td></td> </tr> </tbody> </table> <p>*Only one out of bits 0...3, and one out of bits 9...11 can be on simultaneously. The bit typically indicates the limit that is exceeded first.</p>				Bit	Name	Description	0	Undervoltage	*1 = Intermediate DC circuit undervoltage	1	Overvoltage	*1 = Intermediate DC circuit overvoltage	2	Minimum torque	*1 = Torque is being limited by <a href="#">30.19 Minimum torque 1</a> , <a href="#">30.26 Power motoring limit</a> or <a href="#">30.27 Power generating limit</a>	3	Maximum torque	*1 = Torque is being limited by <a href="#">30.20 Maximum torque 1</a> , <a href="#">30.26 Power motoring limit</a> or <a href="#">30.27 Power generating limit</a>	4	Internal current	1 = An inverter current limit (identified by bits 8...11) is active	5	Load angle	(With permanent magnet motors and reluctance motors only) 1 = Load angle limit is active, ie. the motor cannot produce any more torque	6	Motor pullout	(With asynchronous motors only) Motor pull-out limit is active, ie. the motor cannot produce any more torque	7	Reserved		8	Thermal	1 = Input current is being limited by the main circuit thermal limit	9	Max current	*1 = Maximum output current ( $I_{MAX}$ ) is being limited	10	User current	*1 = Output current is being limited by <a href="#">30.17 Maximum current</a>	11	Thermal IGBT	*1 = Output current is being limited by a calculated thermal current value	12	IGBT overtemperature	*1 = Output current is being limited because of estimated IGBT temperature	13	IGBT overload	*1 = Output current is being limited because of IGBT junction to case temperature	14...15	Reserved	
Bit	Name	Description																																																	
0	Undervoltage	*1 = Intermediate DC circuit undervoltage																																																	
1	Overvoltage	*1 = Intermediate DC circuit overvoltage																																																	
2	Minimum torque	*1 = Torque is being limited by <a href="#">30.19 Minimum torque 1</a> , <a href="#">30.26 Power motoring limit</a> or <a href="#">30.27 Power generating limit</a>																																																	
3	Maximum torque	*1 = Torque is being limited by <a href="#">30.20 Maximum torque 1</a> , <a href="#">30.26 Power motoring limit</a> or <a href="#">30.27 Power generating limit</a>																																																	
4	Internal current	1 = An inverter current limit (identified by bits 8...11) is active																																																	
5	Load angle	(With permanent magnet motors and reluctance motors only) 1 = Load angle limit is active, ie. the motor cannot produce any more torque																																																	
6	Motor pullout	(With asynchronous motors only) Motor pull-out limit is active, ie. the motor cannot produce any more torque																																																	
7	Reserved																																																		
8	Thermal	1 = Input current is being limited by the main circuit thermal limit																																																	
9	Max current	*1 = Maximum output current ( $I_{MAX}$ ) is being limited																																																	
10	User current	*1 = Output current is being limited by <a href="#">30.17 Maximum current</a>																																																	
11	Thermal IGBT	*1 = Output current is being limited by a calculated thermal current value																																																	
12	IGBT overtemperature	*1 = Output current is being limited because of estimated IGBT temperature																																																	
13	IGBT overload	*1 = Output current is being limited because of IGBT junction to case temperature																																																	
14...15	Reserved																																																		
0000h...FFFFh		Torque limitation status word.	1 = 1																																																

No.	Name/Value	Description	Def/FbEq16
30.11	<i>Minimum speed</i>	<p>Defines together with <a href="#">30.12 Maximum speed</a> the allowed speed range. See the figure below.</p> <p>A positive or zero minimum speed value defines two ranges, one positive and one negative.</p> <p>A negative minimum speed value defines one range.</p> <p> <b>WARNING!</b> The absolute value of <a href="#">30.11 Minimum speed</a> must not be higher than the absolute value of <a href="#">30.12 Maximum speed</a>.</p> <p> <b>WARNING!</b> In speed control mode only. In frequency control mode, use frequency limits (<a href="#">30.13</a> and <a href="#">30.14</a>).</p> <div style="display: flex; justify-content: space-around; margin-top: 20px;"> <div data-bbox="218 422 554 630"> <p style="text-align: center;">Speed</p> <p style="text-align: center;">30.11 value &lt; 0</p> <p style="text-align: center;">Speed range allowed</p> <p style="text-align: center;">Time</p> </div> <div data-bbox="610 422 1002 630"> <p style="text-align: center;">Speed</p> <p style="text-align: center;">20.21 value = Request 30.11 value &gt;= 0</p> <p style="text-align: center;">Speed range allowed</p> <p style="text-align: center;">Time</p> </div> <div data-bbox="610 646 1002 853"> <p style="text-align: center;">Speed</p> <p style="text-align: center;">20.21 value = Forward 30.11 value &gt;= 0</p> <p style="text-align: center;">Speed range allowed</p> <p style="text-align: center;">Time</p> </div> </div>	-1500.00 rpm; -1800.00 rpm ( <a href="#">95.20 b0</a> )
	-30000.00... 30000.00 rpm	Minimum allowed speed.	See par. <a href="#">46.01</a>
30.12	<i>Maximum speed</i>	<p>Defines together with <a href="#">30.11 Minimum speed</a> the allowed speed range. See parameter <a href="#">30.11 Minimum speed</a>.</p> <p><b>Note:</b> This parameter does not affect the speed acceleration and deceleration ramp times. See parameter <a href="#">46.01 Speed scaling</a>.</p>	1500.00 rpm; 1800.00 rpm ( <a href="#">95.20 b0</a> )
	-30000.00... 30000.00 rpm	Maximum speed.	See par. <a href="#">46.01</a>

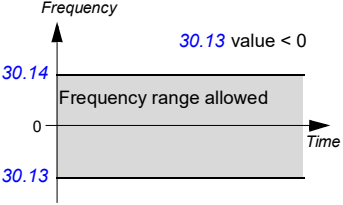
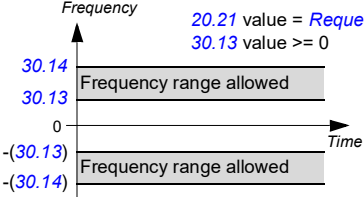
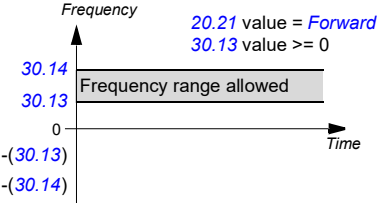
No.	Name/Value	Description	Def/FbEq16
30.13	<i>Minimum frequency</i>	Defines together with <i>30.14 Maximum frequency</i> the allowed frequency range. See the figure. A positive or zero minimum frequency value defines two ranges, one positive and one negative. A negative minimum frequency value defines one range.  <b>WARNING!</b> The absolute value of <i>30.13 Minimum frequency</i> must not be higher than the absolute value of <i>30.14 Maximum frequency</i> .  <b>WARNING!</b> in frequency control mode only.	-50.00 Hz; -60.00 Hz (95.20 b0)
<div style="display: flex; justify-content: space-around;"> <div style="text-align: center;">  <p>Frequency</p> <p>30.14</p> <p>0</p> <p>30.13</p> <p>Time</p> <p>30.13 value &lt; 0</p> </div> <div style="text-align: center;">  <p>Frequency</p> <p>20.21 value = Request</p> <p>30.13 value &gt;= 0</p> <p>30.14</p> <p>30.13</p> <p>0</p> <p>-(30.13)</p> <p>-(30.14)</p> <p>Time</p> </div> <div style="text-align: center;">  <p>Frequency</p> <p>20.21 value = Forward</p> <p>30.13 value &gt;= 0</p> <p>30.14</p> <p>30.13</p> <p>0</p> <p>-(30.13)</p> <p>-(30.14)</p> <p>Time</p> </div> </div>			
	-500.00...500.00 Hz	Minimum frequency.	See par. 46.02
30.14	<i>Maximum frequency</i>	Defines together with <i>30.13 Minimum frequency</i> the allowed frequency range. See parameter <i>30.13 Minimum frequency</i> . <b>Note:</b> This parameter does not affect the frequency acceleration and deceleration ramp times. See parameter <i>46.02 Frequency scaling</i> .	50.00 Hz; 60.00 Hz (95.20 b0)
	-500.00...500.00 Hz	Maximum frequency.	See par. 46.02
30.17	<i>Maximum current</i>	Defines the maximum allowed motor current. This depends on the drive type; it is automatically determined on the basis of the rating. The system sets the default value to 90% of the rated current so you can increase the parameter value by 10% if needed (not valid for ACS580-01-12A7-4 drive type).	0.00 A
	0.00...30000.00 A	Maximum motor current.	1 = 1 A

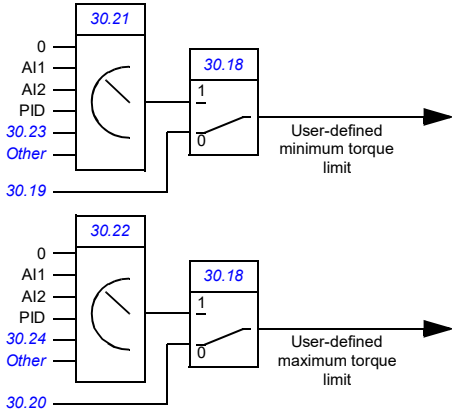

No.	Name/Value	Description	Def/FbEq16
30.18	<i>Torq lim sel</i>	<p>Selects a source that switches between two different predefined minimum torque limit sets.</p> <p>0 = minimum torque limit defined by 30.19 and maximum torque limit defined by 30.20 are active</p> <p>1 = minimum torque limit selected by 30.21 and maximum torque limit defined by 30.22 are active</p> <p>The user can define two sets of torque limits, and switch between the sets using a binary source such as a digital input.</p> <p>The first set of limits is defined by parameters 30.19 and 30.20. The second set has selector parameters for both the minimum (30.21) and maximum (30.22) limits that allows the use of a selectable analog source (such as an analog input).</p>  <p><b>Note:</b> In addition to the user-defined limits, torque may be limited for other reasons (such as power limitation). See the block diagram on page 562.</p>	<i>Torque limit set 1</i>
	Torque limit set 1	0 (minimum torque limit defined by 30.19 and maximum torque limit defined by 30.20 are active).	0
	Torque limit set 2	1 (minimum torque limit selected by 30.21 and maximum torque limit defined by 30.22 are active).	1
	DI1	Digital input DI1 ( <i>10.02 DI delayed status</i> , bit 0).	2
	DI2	Digital input DI2 ( <i>10.02 DI delayed status</i> , bit 1).	3
	DI3	Digital input DI3 ( <i>10.02 DI delayed status</i> , bit 2).	4
	DI4	Digital input DI4 ( <i>10.02 DI delayed status</i> , bit 3).	5
	DI5	Digital input DI5 ( <i>10.02 DI delayed status</i> , bit 4).	6
	DI6	Digital input DI6 ( <i>10.02 DI delayed status</i> , bit 5).	7
	Reserved		8...10
	EFB	Only for the DCU profile. DCU control word bit 15 received through the embedded fieldbus interface.	11
	<i>Other [bit]</i>	Source selection (see <i>Terms and abbreviations</i> on page 196).	-

## 306 Parameters

No.	Name/Value	Description	Def/FbEq16
30.19	<i>Minimum torque 1</i>	Defines a minimum torque limit for the drive (in percent of nominal motor torque). See diagram at parameter <a href="#">30.18 Torq lim sel</a> . The limit is effective when <ul style="list-style-type: none"> <li>the source selected by <a href="#">30.18 Torq lim sel</a> is 0, or</li> <li><a href="#">30.18</a> is set to <a href="#">Torque limit set 1</a>.</li> </ul>	-300.0%
	-1600.0...0.0%	Minimum torque limit 1.	See par. <a href="#">46.03</a>
30.20	<i>Maximum torque 1</i>	Defines a maximum torque limit for the drive (in percent of nominal motor torque). See diagram at parameter <a href="#">30.18 Torq lim sel</a> . The limit is effective when <ul style="list-style-type: none"> <li>the source selected by <a href="#">30.18 Torq lim sel</a> is 0, or</li> <li><a href="#">30.18</a> is set to <a href="#">Torque limit set 1</a>.</li> </ul>	300.0%
	0.0...1600.0%	Maximum torque 1.	See par. <a href="#">46.03</a>
30.21	<i>Min torque 2 source</i>	Defines the source of the minimum torque limit for the drive (in percent of nominal motor torque) when <ul style="list-style-type: none"> <li>the source selected by parameter <a href="#">30.18 Torq lim sel</a> is 1, or</li> <li><a href="#">30.18</a> is set to <a href="#">Torque limit set 2</a>.</li> </ul> See diagram at <a href="#">30.18 Torq lim sel</a> . <b>Note:</b> Any positive values received from the selected source are inverted.	<i>Minimum torque 2</i>
	Zero	None.	0
	AI1 scaled	<a href="#">12.12 AI1 scaled value</a> (see page <a href="#">227</a> ).	1
	AI2 scaled	<a href="#">12.22 AI2 scaled value</a> (see page <a href="#">229</a> ).	2
	Reserved		3...14
	PID	<a href="#">40.01 Process PID output actual</a> (output of the process PID controller).	15
	Minimum torque 2	<a href="#">30.23 Minimum torque 2</a> .	16
	<i>Other</i>	Source selection (see <a href="#">Terms and abbreviations</a> on page <a href="#">196</a> ).	-
30.22	<i>Max torque 2 source</i>	Defines the source of the maximum torque limit for the drive (in percent of nominal motor torque) when <ul style="list-style-type: none"> <li>the source selected by parameter <a href="#">30.18 Torq lim sel</a> is 1, or</li> <li><a href="#">30.18</a> is set to <a href="#">Torque limit set 2</a>.</li> </ul> See diagram at <a href="#">30.18 Torq lim sel</a> . <b>Note:</b> Any negative values received from the selected source are inverted.	<i>Maximum torque 2</i>
	Zero	None.	0
	AI1 scaled	<a href="#">12.12 AI1 scaled value</a> (see page <a href="#">227</a> ).	1
	AI2 scaled	<a href="#">12.22 AI2 scaled value</a> (see page <a href="#">229</a> ).	2
	Reserved		3...14
	PID	<a href="#">40.01 Process PID output actual</a> (output of the process PID controller).	15
	Maximum torque 2	<a href="#">30.24 Maximum torque 2</a> .	16
	<i>Other</i>	Source selection (see <a href="#">Terms and abbreviations</a> on page <a href="#">196</a> ).	-

No.	Name/Value	Description	Def/FbEq16
30.23	<i>Minimum torque 2</i>	Defines the minimum torque limit for the drive (in percent of nominal motor torque) when <ul style="list-style-type: none"> <li>the source selected by <a href="#">30.18 Torq lim sel</a> is 1, or</li> <li><a href="#">30.18</a> is set to <a href="#">Torque limit set 2</a></li> </ul> and <ul style="list-style-type: none"> <li><a href="#">30.21 Min torque 2 source</a> is set to <a href="#">Minimum torque 2</a>.</li> </ul> See diagram at <a href="#">30.18 Torq lim sel</a> .	-300.0%
	-1600.0...0.0%	Minimum torque limit 2.	See par. <a href="#">46.03</a>
30.24	<i>Maximum torque 2</i>	Defines the maximum torque limit for the drive (in percent of nominal motor torque) when The limit is effective when <ul style="list-style-type: none"> <li>the source selected by <a href="#">30.18 Torq lim sel</a> is 1, or</li> <li><a href="#">30.18</a> is set to <a href="#">Torque limit set 2</a></li> </ul> and <ul style="list-style-type: none"> <li><a href="#">30.22 Max torque 2 source</a> is set to <a href="#">Maximum torque 2</a>.</li> </ul> See diagram at <a href="#">30.18 Torq lim sel</a> .	300.0%
	0.0...1600.0%	Maximum torque limit 2.	See par. <a href="#">46.03</a>
30.26	<i>Power motoring limit</i>	Defines the maximum allowed power fed by the inverter to the motor in percent of nominal motor power.	300.00%
	0.00...600.00%	Maximum motoring power.	1 = 1%
30.27	<i>Power generating limit</i>	Defines the maximum allowed power fed by the motor to the inverter in percent of nominal motor power. <b>Note:</b> If your application, like a pump or a fan, requires that the motor must rotate in one direction only, use speed/frequency limit ( <a href="#">30.11 Minimum speed/30.13 Minimum frequency</a> ), or direction limit ( <a href="#">20.21 Direction</a> ) to achieve this. Do not set parameter <a href="#">30.19 Minimum torque 1</a> or <a href="#">30.27 Power generating limit</a> to 0%, as the drive is then not able to stop correctly.	-300.00%
	-600.00...0.00%	Maximum generating power.	1 = 1%
30.30	<i>Overvoltage control</i>	Enables the overvoltage control of the intermediate DC link. Fast braking of a high inertia load causes the voltage to rise to the overvoltage control limit. To prevent the DC voltage from exceeding the limit, the overvoltage controller automatically decreases the braking torque. <b>Note:</b> If the drive is equipped with a brake chopper and resistor, or a regenerative supply unit, the controller must be disabled.	<a href="#">Enable</a>
	Disable	Overvoltage control disabled.	0
	Enable	Overvoltage control enabled.	1
30.31	<i>Undervoltage control</i>	Enables the undervoltage control of the intermediate DC link. If the DC voltage drops due to input power cut off, the undervoltage controller will automatically decrease the motor torque in order to keep the voltage above the lower limit. By decreasing the motor torque, the inertia of the load will cause regeneration back to the drive, keeping the DC link charged and preventing an undervoltage trip until the motor coasts to a stop. This will act as a power-loss ride-through functionality in systems with high inertia, such as a centrifuge or a fan.	<a href="#">Enable</a>
	Disable	Undervoltage control disabled.	0
	Enable	Undervoltage control enabled.	1

No.	Name/Value	Description	Def/FbEq16
30.35	<i>Thermal current limitation</i>	Enables/disables temperature-based output current limitation. The limitation should only be disabled if required by the application.	<i>Enable</i>
	Disable	Thermal current limitation disabled.	0
	Enable	Thermal current limitation enabled.	1
30.36	<i>Speed limit selection</i>	<p>Selects a source that switches between two different predefined adjustable speed limit sets.</p> <p>0 = minimum speed limit defined by 30.11 and maximum speed limit defined by 30.12 are active</p> <p>1 = minimum speed limit selected by 30.37 and maximum speed limit defined by 30.38 are active</p> <p>The user can define two sets of speed limits, and switch between the sets using a binary source such as a digital input.</p> <p>The first set of limits is defined by parameters 30.11 <i>Minimum speed</i> and 30.12 <i>Maximum speed</i>. The second set has selector parameters for both the minimum (30.37) and maximum (30.38) limits that allows the use of a selectable analog source (such as an analog input).</p>	<i>Not selected</i>
	Not selected	Adjustable speed limits are disabled. (Minimum speed limit defined by 30.11 <i>Minimum speed</i> and maximum speed limit defined by 30.12 <i>Maximum speed</i> are active).	0
	Selected	Adjustable speed limits are enabled. (Minimum speed limit defined by 30.37 <i>Minimum speed source</i> and maximum speed limit defined by 30.38 <i>Maximum speed source</i> are active).	1
	Ext1 active	Adjustable speed limits are enabled if EXT1 is active.	2
	Ext2 active	Adjustable speed limits are enabled if EXT2 is active.	3
	Torque control	Adjustable speed limits are enabled if Torque control mode (vector motor control) is active.	4
	DI1	Digital input DI1 ( <i>10.02 DI delayed status</i> , bit 0).	5
	DI2	Digital input DI2 ( <i>10.02 DI delayed status</i> , bit 1).	6
	DI3	Digital input DI3 ( <i>10.02 DI delayed status</i> , bit 2).	7

No.	Name/Value	Description	Def/FbEq16
	DI4	Digital input DI4 ( <i>10.02 DI delayed status</i> , bit 3).	8
	DI5	Digital input DI5 ( <i>10.02 DI delayed status</i> , bit 4).	9
	DI6	Digital input DI6 ( <i>10.02 DI delayed status</i> , bit 5).	10
	Reserved		11
	<i>Other [bit]</i>	Source selection (see <i>Terms and abbreviations</i> on page 196).	-
<b>30.37</b>	<b><i>Minimum speed source</i></b>	Defines the source of a minimum speed limit for the drive when the source is selected by <b>30.36 <i>Speed limit selection</i></b> . <b>Note:</b> In vector motor control mode only. In scalar motor control mode, use frequency limits <b>30.13</b> and <b>30.14</b> .	<b><i>Minimum speed</i></b>
	Zero	None.	0
	AI1 scaled	<b>12.12 <i>AI1 scaled value</i></b> (see page 227).	1
	AI2 scaled	<b>12.22 <i>AI2 scaled value</i></b> (see page 229).	2
	Reserved		3...10
	Minimum speed	<b>30.11 <i>Minimum speed</i></b> .	11
	<i>Other</i>	Source selection (see <i>Terms and abbreviations</i> on page 196).	-
<b>30.38</b>	<b><i>Maximum speed source</i></b>	Defines the source of a maximum speed limit for the drive when the source is selected by <b>30.36 <i>Speed limit selection</i></b> . <b>Note:</b> In vector motor control mode only. In scalar motor control mode, use frequency limits <b>30.13</b> and <b>30.14</b> .	<b><i>Maximum speed</i></b>
	Zero	None.	0
	AI1 scaled	<b>12.12 <i>AI1 scaled value</i></b> (see page 227).	1
	AI2 scaled	<b>12.22 <i>AI2 scaled value</i></b> (see page 229).	2
	Reserved		3...11
	Maximum speed	<b>30.12 <i>Maximum speed</i></b> .	12
	<i>Other</i>	Source selection (see <i>Terms and abbreviations</i> on page 196).	-
<b>31 <i>Fault functions</i></b>		Configuration of external events; selection of behavior of the drive upon fault situations.	
<b>31.01</b>	<b><i>External event 1 source</i></b>	Defines the source of external event 1. See also parameter <b>31.02 <i>External event 1 type</i></b> . 0 = Trigger event 1 = Normal operation	<b><i>Inactive (true)</i></b>
	Active (false)	0.	0
	Inactive (true)	1.	1
	Reserved		2
	DI1	Digital input DI1 ( <i>10.02 DI delayed status</i> , bit 0).	3
	DI2	Digital input DI2 ( <i>10.02 DI delayed status</i> , bit 1).	4
	DI3	Digital input DI3 ( <i>10.02 DI delayed status</i> , bit 2).	5
	DI4	Digital input DI4 ( <i>10.02 DI delayed status</i> , bit 3).	6
	DI5	Digital input DI5 ( <i>10.02 DI delayed status</i> , bit 4).	7
	DI6	Digital input DI6 ( <i>10.02 DI delayed status</i> , bit 5).	8
	<i>Other [bit]</i>	Source selection (see <i>Terms and abbreviations</i> on page 196).	-
<b>31.02</b>	<b><i>External event 1 type</i></b>	Selects the type of external event 1.	<b><i>Fault</i></b>
	Fault	The external event generates a fault.	0

## 310 Parameters

No.	Name/Value	Description	Def/FbEq16
	Warning	The external event generates a warning.	1
31.03	<i>External event 2 source</i>	Defines the source of external event 2. See also parameter <a href="#">31.04 External event 2 type</a> . For the selections, see parameter <a href="#">31.01 External event 1 source</a> .	<i>Inactive (true)</i>
31.04	<i>External event 2 type</i>	Selects the type of external event 2.	<i>Fault</i>
	Fault	The external event generates a fault.	0
	Warning	The external event generates a warning.	1
31.05	<i>External event 3 source</i>	Defines the source of external event 3. See also parameter <a href="#">31.06 External event 3 type</a> . For the selections, see parameter <a href="#">31.01 External event 1 source</a> .	<i>Inactive (true)</i>
31.06	<i>External event 3 type</i>	Selects the type of external event 3.	<i>Fault</i>
	Fault	The external event generates a fault.	0
	Warning	The external event generates a warning.	1
31.07	<i>External event 4 source</i>	Defines the source of external event 4. See also parameter <a href="#">31.08 External event 4 type</a> . For the selections, see parameter <a href="#">31.01 External event 1 source</a> .	<i>Inactive (true)</i>
31.08	<i>External event 4 type</i>	Selects the type of external event 4.	<i>Fault</i>
	Fault	The external event generates a fault.	0
	Warning	The external event generates a warning.	1
31.09	<i>External event 5 source</i>	Defines the source of external event 5. See also parameter <a href="#">31.10 External event 5 type</a> . For the selections, see parameter <a href="#">31.01 External event 1 source</a> .	<i>Inactive (true)</i>
31.10	<i>External event 5 type</i>	Selects the type of external event 5.	<i>Fault</i>
	Fault	The external event generates a fault.	0
	Warning	The external event generates a warning.	1
31.11	<i>Fault reset selection</i>	Selects the source of an external fault reset signal. The signal resets the drive after a fault trip if the cause of the fault no longer exists. 0 -> 1 = Reset <b>Notes:</b> <ul style="list-style-type: none"> <li>When the start and stop command is through digital inputs (parameter <a href="#">20.01 Ext1 commands</a> or <a href="#">20.06 Ext2 commands</a>) or from local control, and you want to use fault reset from the fieldbus, selection <a href="#">FBA A MCW bit 7</a> or <a href="#">EFB MCW bit 7</a> can be used.</li> <li>Whenever the drive is in external control through fieldbus (start and stop command and reference are received through fieldbus), the fault can be reset from the fieldbus regardless of the selection of this parameter.</li> </ul>	<i>Not used</i>
	Not used	0.	0
	Not used	1.	1
	DI1	Digital input DI1 ( <a href="#">10.02 DI delayed status</a> , bit 0).	2

No.	Name/Value	Description	Def/FbEq16																								
	DI2	Digital input DI2 ( <a href="#">10.02 DI delayed status</a> , bit 1).	3																								
	DI3	Digital input DI3 ( <a href="#">10.02 DI delayed status</a> , bit 2).	4																								
	DI4	Digital input DI4 ( <a href="#">10.02 DI delayed status</a> , bit 3).	5																								
	DI5	Digital input DI5 ( <a href="#">10.02 DI delayed status</a> , bit 4).	6																								
	DI6	Digital input DI6 ( <a href="#">10.02 DI delayed status</a> , bit 5).	7																								
	Reserved		8...17																								
	Timed function 1	Bit 0 of <a href="#">34.01 Timed functions status</a> (see page <a href="#">327</a> ).	18																								
	Timed function 2	Bit 1 of <a href="#">34.01 Timed functions status</a> (see page <a href="#">327</a> ).	19																								
	Timed function 3	Bit 2 of <a href="#">34.01 Timed functions status</a> (see page <a href="#">327</a> ).	20																								
	Reserved		21...23																								
	Supervision 1	Bit 0 of <a href="#">32.01 Supervision status</a> (see page <a href="#">319</a> ).	24																								
	Supervision 2	Bit 1 of <a href="#">32.01 Supervision status</a> (see page <a href="#">319</a> ).	25																								
	Supervision 3	Bit 2 of <a href="#">32.01 Supervision status</a> (see page <a href="#">319</a> ).	26																								
	Reserved		27...29																								
	FBA A MCW bit 7	Control word bit 7 received through fieldbus interface A.	30																								
	Reserved		31																								
	EFB MCW bit 7	Control word bit 7 received through the embedded fieldbus interface.	32																								
	<a href="#">Other [bit]</a>	Source selection (see <a href="#">Terms and abbreviations</a> on page <a href="#">196</a> ).	-																								
<a href="#">31.12</a>	<a href="#">Autoreset selection</a>	<p>Selects faults that are automatically reset. The parameter is a 16-bit word with each bit corresponding to a fault type. Whenever a bit is set to 1, the corresponding fault is automatically reset.</p> <p> <b>WARNING!</b> Before you activate the function, make sure that no dangerous situations can occur. The function restarts the drive automatically and continues operation after a fault.</p> <p>The bits of this binary number correspond to the following faults:</p> <table border="1" data-bbox="213 1029 1016 1353"> <thead> <tr> <th>Bit</th> <th>Fault</th> </tr> </thead> <tbody> <tr> <td>0</td> <td>Overcurrent</td> </tr> <tr> <td>1</td> <td>Overvoltage</td> </tr> <tr> <td>2</td> <td>Undervoltage</td> </tr> <tr> <td>3</td> <td>AI supervision fault</td> </tr> <tr> <td>4...9</td> <td>Reserved</td> </tr> <tr> <td>10</td> <td>Selectable fault (see parameter <a href="#">31.13 Selectable fault</a>)</td> </tr> <tr> <td>11</td> <td>External fault 1 (from source selected by parameter <a href="#">31.01 External event 1 source</a>)</td> </tr> <tr> <td>12</td> <td>External fault 2 (from source selected by parameter <a href="#">31.03 External event 2 source</a>)</td> </tr> <tr> <td>13</td> <td>External fault 3 (from source selected by parameter <a href="#">31.05 External event 3 source</a>)</td> </tr> <tr> <td>14</td> <td>External fault 4 (from source selected by parameter <a href="#">31.07 External event 4 source</a>)</td> </tr> <tr> <td>15</td> <td>External fault 5 (from source selected by parameter <a href="#">31.09 External event 5 source</a>)</td> </tr> </tbody> </table>	Bit	Fault	0	Overcurrent	1	Overvoltage	2	Undervoltage	3	AI supervision fault	4...9	Reserved	10	Selectable fault (see parameter <a href="#">31.13 Selectable fault</a> )	11	External fault 1 (from source selected by parameter <a href="#">31.01 External event 1 source</a> )	12	External fault 2 (from source selected by parameter <a href="#">31.03 External event 2 source</a> )	13	External fault 3 (from source selected by parameter <a href="#">31.05 External event 3 source</a> )	14	External fault 4 (from source selected by parameter <a href="#">31.07 External event 4 source</a> )	15	External fault 5 (from source selected by parameter <a href="#">31.09 External event 5 source</a> )	0000h
Bit	Fault																										
0	Overcurrent																										
1	Overvoltage																										
2	Undervoltage																										
3	AI supervision fault																										
4...9	Reserved																										
10	Selectable fault (see parameter <a href="#">31.13 Selectable fault</a> )																										
11	External fault 1 (from source selected by parameter <a href="#">31.01 External event 1 source</a> )																										
12	External fault 2 (from source selected by parameter <a href="#">31.03 External event 2 source</a> )																										
13	External fault 3 (from source selected by parameter <a href="#">31.05 External event 3 source</a> )																										
14	External fault 4 (from source selected by parameter <a href="#">31.07 External event 4 source</a> )																										
15	External fault 5 (from source selected by parameter <a href="#">31.09 External event 5 source</a> )																										
	0000h...FFFFh	Automatic reset configuration word.	1 = 1																								

## 312 Parameters

No.	Name/Value	Description	Def/FbEq16
31.13	<i>Selectable fault</i>	Defines the fault that can be automatically reset using parameter <a href="#">31.12 Autoreset selection</a> , bit 10. Faults are listed in chapter <a href="#">Fault tracing</a> (page 493).	0000h
	0000h...FFFFh	Fault code.	10 = 1
31.14	<i>Number of trials</i>	Defines the maximum number of automatic resets that the drive is allowed to attempt within the time specified by <a href="#">31.15 Total trials time</a> . If the fault persists, subsequent reset attempts will be made at intervals defined by <a href="#">31.16 Delay time</a> . The faults to be automatically reset are defined by <a href="#">31.12 Autoreset selection</a> .	0
	0...5	Number of automatic resets.	10 = 1
31.15	<i>Total trials time</i>	Defines a time window for automatic fault resets. The maximum number of attempts made during any period of this length is defined by <a href="#">31.14 Number of trials</a> . <b>Note:</b> If the fault condition remains and cannot be reset, each reset attempt will generate an event and start a new time window. In practice, if the specified number of resets ( <a href="#">31.14</a> ) at specified intervals ( <a href="#">31.16</a> ) take longer than the value of <a href="#">31.15</a> , the drive will continue to attempt resetting the fault until the cause is eventually removed.	30.0 s
	1.0...600.0 s	Time for automatic resets.	10 = 1 s
31.16	<i>Delay time</i>	Defines the time that the drive will wait after a fault before attempting an automatic reset. See parameter <a href="#">31.12 Autoreset selection</a> .	0.0 s
	0.0...120.0 s	Autoreset delay.	10 = 1 s
31.19	<i>Motor phase loss</i>	Selects how the drive reacts when a motor phase loss is detected. In scalar motor control mode: <ul style="list-style-type: none"> <li>The supervision activates above 10% of the motor nominal frequency. If any of the phase currents stays very small for a certain time limit, the output phase loss fault is given.</li> <li>If the motor nominal current is below 1/6 of the drive nominal current or there is no motor connected, ABB recommends to disable the motor output phase loss function.</li> </ul>	<i>Fault</i>
	No action	No action taken.	0
	Fault	The drive trips on fault <a href="#">3381 Output phase loss</a> .	1
31.21	<i>Supply phase loss</i>	Selects how the drive reacts when a supply phase loss is detected.	<i>Fault</i>
	No action	No action taken.	0
	Fault	The drive trips on fault <a href="#">3130 Input phase loss</a> .	1



No.	Name/Value	Description	Def/FbEq16																							
31.22	<i>STO indication run/stop</i>	<p>Selects which indications are given when one or both Safe torque off (STO) signals are switched off or lost. The indications also depend on whether the drive is running or stopped when this occurs.</p> <p>The tables at each selection below show the indications generated with that particular setting.</p> <p>When using Warning/Event/No indication and fieldbus control, check that the parameter <i>06.18</i> bit 7 STO = 0 before giving start command.</p> <p><b>Notes:</b></p> <ul style="list-style-type: none"> <li>This parameter does not affect the operation of the STO function itself. The STO function will operate regardless of the setting of this parameter: a running drive will stop upon removal of one or both STO signals, and will not start until both STO signals are restored and all faults reset.</li> <li>The loss of only one STO signal always generates a fault as it is interpreted as a malfunction. With the CPTC-02 ATEX-certified thermistor protection module, follow the instructions given in the <i>CPTC-02 ATEX-certified thermistor protection module, Ex II (2) GD (+L537+Q971) user's manual</i> (3AXD50000030058 [English]).</li> </ul> <p>For more information on the STO, see chapter <i>The Safe torque off function</i> in the <i>Hardware manual</i> of the drive.</p>	<i>Fault/Fault</i>																							
Fault/Fault	<table border="1" data-bbox="395 719 908 922"> <thead> <tr> <th colspan="2" data-bbox="395 719 507 742">Inputs</th> <th data-bbox="512 719 908 742" rowspan="2">Indication (running or stopped)</th> </tr> <tr> <th data-bbox="395 743 456 766">IN1</th> <th data-bbox="456 743 507 766">IN2</th> </tr> </thead> <tbody> <tr> <td data-bbox="395 767 456 790">0</td> <td data-bbox="456 767 507 790">0</td> <td data-bbox="512 767 908 790">Fault <i>5091 Safe torque off</i></td> </tr> <tr> <td data-bbox="395 791 456 813">0</td> <td data-bbox="456 791 507 813">1</td> <td data-bbox="512 791 908 813">Faults <i>5091 Safe torque off</i> and <i>FA81 Safe torque off 1</i></td> </tr> <tr> <td data-bbox="395 815 456 837">1</td> <td data-bbox="456 815 507 837">0</td> <td data-bbox="512 815 908 837">Faults <i>5091 Safe torque off</i> and <i>FA82 Safe torque off 2</i></td> </tr> <tr> <td data-bbox="395 839 456 861">1</td> <td data-bbox="456 839 507 861">1</td> <td data-bbox="512 839 908 861">(Normal operation)</td> </tr> </tbody> </table>	Inputs		Indication (running or stopped)	IN1	IN2	0	0	Fault <i>5091 Safe torque off</i>	0	1	Faults <i>5091 Safe torque off</i> and <i>FA81 Safe torque off 1</i>	1	0	Faults <i>5091 Safe torque off</i> and <i>FA82 Safe torque off 2</i>	1	1	(Normal operation)	0							
Inputs		Indication (running or stopped)																								
IN1	IN2																									
0	0	Fault <i>5091 Safe torque off</i>																								
0	1	Faults <i>5091 Safe torque off</i> and <i>FA81 Safe torque off 1</i>																								
1	0	Faults <i>5091 Safe torque off</i> and <i>FA82 Safe torque off 2</i>																								
1	1	(Normal operation)																								
Fault/Warning	<table border="1" data-bbox="395 991 908 1257"> <thead> <tr> <th colspan="2" data-bbox="395 991 507 1013">Inputs</th> <th colspan="2" data-bbox="512 991 908 1013">Indication</th> </tr> <tr> <th data-bbox="395 1015 456 1037">IN1</th> <th data-bbox="456 1015 507 1037">IN2</th> <th data-bbox="512 1015 720 1037">Running</th> <th data-bbox="725 1015 908 1037">Stopped</th> </tr> </thead> <tbody> <tr> <td data-bbox="395 1038 456 1061">0</td> <td data-bbox="456 1038 507 1061">0</td> <td data-bbox="512 1038 720 1061">Fault <i>5091 Safe torque off</i></td> <td data-bbox="725 1038 908 1061">Warning <i>A5A0 Safe torque off</i></td> </tr> <tr> <td data-bbox="395 1062 456 1085">0</td> <td data-bbox="456 1062 507 1085">1</td> <td data-bbox="512 1062 720 1085">Faults <i>5091 Safe torque off</i> and <i>FA81 Safe torque off 1</i></td> <td data-bbox="725 1062 908 1085">Warning <i>A5A0 Safe torque off</i> and fault <i>FA81 Safe torque off 1</i></td> </tr> <tr> <td data-bbox="395 1086 456 1109">1</td> <td data-bbox="456 1086 507 1109">0</td> <td data-bbox="512 1086 720 1109">Faults <i>5091 Safe torque off</i> and <i>FA82 Safe torque off 2</i></td> <td data-bbox="725 1086 908 1109">Warning <i>A5A0 Safe torque off</i> and fault <i>FA82 Safe torque off 2</i></td> </tr> <tr> <td data-bbox="395 1110 456 1133">1</td> <td data-bbox="456 1110 507 1133">1</td> <td colspan="2" data-bbox="512 1110 908 1133">(Normal operation)</td> </tr> </tbody> </table>	Inputs		Indication		IN1	IN2	Running	Stopped	0	0	Fault <i>5091 Safe torque off</i>	Warning <i>A5A0 Safe torque off</i>	0	1	Faults <i>5091 Safe torque off</i> and <i>FA81 Safe torque off 1</i>	Warning <i>A5A0 Safe torque off</i> and fault <i>FA81 Safe torque off 1</i>	1	0	Faults <i>5091 Safe torque off</i> and <i>FA82 Safe torque off 2</i>	Warning <i>A5A0 Safe torque off</i> and fault <i>FA82 Safe torque off 2</i>	1	1	(Normal operation)		1
Inputs		Indication																								
IN1	IN2	Running	Stopped																							
0	0	Fault <i>5091 Safe torque off</i>	Warning <i>A5A0 Safe torque off</i>																							
0	1	Faults <i>5091 Safe torque off</i> and <i>FA81 Safe torque off 1</i>	Warning <i>A5A0 Safe torque off</i> and fault <i>FA81 Safe torque off 1</i>																							
1	0	Faults <i>5091 Safe torque off</i> and <i>FA82 Safe torque off 2</i>	Warning <i>A5A0 Safe torque off</i> and fault <i>FA82 Safe torque off 2</i>																							
1	1	(Normal operation)																								

### 314 Parameters

No.	Name/Value	Description	Def/FbEq16																								
	Fault/Event	<table border="1"> <thead> <tr> <th colspan="2">Inputs</th> <th colspan="2">Indication</th> </tr> <tr> <th>IN1</th> <th>IN2</th> <th>Running</th> <th>Stopped</th> </tr> </thead> <tbody> <tr> <td>0</td> <td>0</td> <td>Fault <i>5091 Safe torque off</i></td> <td>Event <i>B5A0 STO event</i></td> </tr> <tr> <td>0</td> <td>1</td> <td>Faults <i>5091 Safe torque off</i> and <i>FA81 Safe torque off 1</i></td> <td>Event <i>B5A0 STO event</i> and fault <i>FA81 Safe torque off 1</i></td> </tr> <tr> <td>1</td> <td>0</td> <td>Faults <i>5091 Safe torque off</i> and <i>FA82 Safe torque off 2</i></td> <td>Event <i>B5A0 STO event</i> and fault <i>FA82 Safe torque off 2</i></td> </tr> <tr> <td>1</td> <td>1</td> <td colspan="2">(Normal operation)</td> </tr> </tbody> </table>	Inputs		Indication		IN1	IN2	Running	Stopped	0	0	Fault <i>5091 Safe torque off</i>	Event <i>B5A0 STO event</i>	0	1	Faults <i>5091 Safe torque off</i> and <i>FA81 Safe torque off 1</i>	Event <i>B5A0 STO event</i> and fault <i>FA81 Safe torque off 1</i>	1	0	Faults <i>5091 Safe torque off</i> and <i>FA82 Safe torque off 2</i>	Event <i>B5A0 STO event</i> and fault <i>FA82 Safe torque off 2</i>	1	1	(Normal operation)		2
Inputs		Indication																									
IN1	IN2	Running	Stopped																								
0	0	Fault <i>5091 Safe torque off</i>	Event <i>B5A0 STO event</i>																								
0	1	Faults <i>5091 Safe torque off</i> and <i>FA81 Safe torque off 1</i>	Event <i>B5A0 STO event</i> and fault <i>FA81 Safe torque off 1</i>																								
1	0	Faults <i>5091 Safe torque off</i> and <i>FA82 Safe torque off 2</i>	Event <i>B5A0 STO event</i> and fault <i>FA82 Safe torque off 2</i>																								
1	1	(Normal operation)																									
	Warning/Warning	<table border="1"> <thead> <tr> <th colspan="2">Inputs</th> <th rowspan="2">Indication (running or stopped)</th> </tr> <tr> <th>IN1</th> <th>IN2</th> </tr> </thead> <tbody> <tr> <td>0</td> <td>0</td> <td>Warning <i>A5A0 Safe torque off</i></td> </tr> <tr> <td>0</td> <td>1</td> <td>Warning <i>A5A0 Safe torque off</i> and fault <i>FA81 Safe torque off 1</i></td> </tr> <tr> <td>1</td> <td>0</td> <td>Warning <i>A5A0 Safe torque off</i> and fault <i>FA82 Safe torque off 2</i></td> </tr> <tr> <td>1</td> <td>1</td> <td>(Normal operation)</td> </tr> </tbody> </table>	Inputs		Indication (running or stopped)	IN1	IN2	0	0	Warning <i>A5A0 Safe torque off</i>	0	1	Warning <i>A5A0 Safe torque off</i> and fault <i>FA81 Safe torque off 1</i>	1	0	Warning <i>A5A0 Safe torque off</i> and fault <i>FA82 Safe torque off 2</i>	1	1	(Normal operation)	3							
Inputs		Indication (running or stopped)																									
IN1	IN2																										
0	0	Warning <i>A5A0 Safe torque off</i>																									
0	1	Warning <i>A5A0 Safe torque off</i> and fault <i>FA81 Safe torque off 1</i>																									
1	0	Warning <i>A5A0 Safe torque off</i> and fault <i>FA82 Safe torque off 2</i>																									
1	1	(Normal operation)																									
	Event/Event	<table border="1"> <thead> <tr> <th colspan="2">Inputs</th> <th rowspan="2">Indication (running or stopped)</th> </tr> <tr> <th>IN1</th> <th>IN2</th> </tr> </thead> <tbody> <tr> <td>0</td> <td>0</td> <td>Event <i>B5A0 STO event</i></td> </tr> <tr> <td>0</td> <td>1</td> <td>Event <i>B5A0 STO event</i> and fault <i>FA81 Safe torque off 1</i></td> </tr> <tr> <td>1</td> <td>0</td> <td>Event <i>B5A0 STO event</i> and fault <i>FA82 Safe torque off 2</i></td> </tr> <tr> <td>1</td> <td>1</td> <td>(Normal operation)</td> </tr> </tbody> </table>	Inputs		Indication (running or stopped)	IN1	IN2	0	0	Event <i>B5A0 STO event</i>	0	1	Event <i>B5A0 STO event</i> and fault <i>FA81 Safe torque off 1</i>	1	0	Event <i>B5A0 STO event</i> and fault <i>FA82 Safe torque off 2</i>	1	1	(Normal operation)	4							
Inputs		Indication (running or stopped)																									
IN1	IN2																										
0	0	Event <i>B5A0 STO event</i>																									
0	1	Event <i>B5A0 STO event</i> and fault <i>FA81 Safe torque off 1</i>																									
1	0	Event <i>B5A0 STO event</i> and fault <i>FA82 Safe torque off 2</i>																									
1	1	(Normal operation)																									
	No indication/No indication	<table border="1"> <thead> <tr> <th colspan="2">Inputs</th> <th rowspan="2">Indication (running or stopped)</th> </tr> <tr> <th>IN1</th> <th>IN2</th> </tr> </thead> <tbody> <tr> <td>0</td> <td>0</td> <td>None</td> </tr> <tr> <td>0</td> <td>1</td> <td>Fault <i>FA81 Safe torque off 1</i></td> </tr> <tr> <td>1</td> <td>0</td> <td>Fault <i>FA82 Safe torque off 2</i></td> </tr> <tr> <td>1</td> <td>1</td> <td>(Normal operation)</td> </tr> </tbody> </table>	Inputs		Indication (running or stopped)	IN1	IN2	0	0	None	0	1	Fault <i>FA81 Safe torque off 1</i>	1	0	Fault <i>FA82 Safe torque off 2</i>	1	1	(Normal operation)	5							
Inputs		Indication (running or stopped)																									
IN1	IN2																										
0	0	None																									
0	1	Fault <i>FA81 Safe torque off 1</i>																									
1	0	Fault <i>FA82 Safe torque off 2</i>																									
1	1	(Normal operation)																									
31.23	<i>Wiring or earth fault</i>	Selects how the drive reacts to incorrect input power and motor cable connection (ie. input power cable is connected to drive motor connection).	<i>Fault</i>																								
	No action	No action taken.	0																								
	Fault	The drive trips on fault <i>3181 Wiring or earth fault</i> .	1																								

No.	Name/Value	Description	Def/FbEq16
<a href="#">31.24</a>	<a href="#">Stall function</a>	Selects how the drive reacts to a motor stall condition. A stall condition is defined as follows: <ul style="list-style-type: none"> <li>• The drive exceeds the stall current limit (<a href="#">31.25 Stall current limit</a>), and</li> <li>• the output frequency is below the level set by parameter <a href="#">31.27 Stall frequency limit</a> or the motor speed is below the level set by parameter <a href="#">31.26 Stall speed limit</a>, and</li> <li>• the conditions above have been true longer than the time set by parameter <a href="#">31.28 Stall time</a>.</li> </ul>	<a href="#">No action</a>
	No action	None (stall supervision disabled).	0
	Warning	The drive generates an <a href="#">A780 Motor stall</a> warning.	1
	Fault	The drive trips on fault <a href="#">7121 Motor stall</a> .	2
<a href="#">31.25</a>	<a href="#">Stall current limit</a>	Stall current limit in percent of the nominal current of the motor. See parameter <a href="#">31.24 Stall function</a> .	200.0%
	0.0...1600.0%	Stall current limit.	-
<a href="#">31.26</a>	<a href="#">Stall speed limit</a>	Stall speed limit in rpm. See parameter <a href="#">31.24 Stall function</a> .	150.00 rpm; 180.00 rpm ( <a href="#">95.20 b0</a> )
	0.00...10000.00 rpm	Stall speed limit.	See par. <a href="#">46.01</a>
<a href="#">31.27</a>	<a href="#">Stall frequency limit</a>	Stall frequency limit. See parameter <a href="#">31.24 Stall function</a> . <b>Note:</b> Setting the limit below 10 Hz is not recommended.	15.00 Hz; 18.00 Hz ( <a href="#">95.20 b0</a> )
	0.00...1000.00 Hz	Stall frequency limit.	See par. <a href="#">46.02</a>
<a href="#">31.28</a>	<a href="#">Stall time</a>	Stall time. See parameter <a href="#">31.24 Stall function</a> .	20 s
	0...3600 s	Stall time.	-

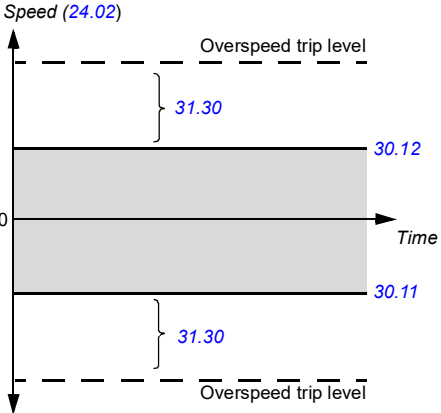
No.	Name/Value	Description	Def/FbEq16
31.30	<i>Overspeed trip margin</i>	<p>Defines, together with <a href="#">30.11 Minimum speed</a> and <a href="#">30.12 Maximum speed</a>, the maximum allowed speed of the motor (overspeed protection). If the speed (<a href="#">24.02 Used speed feedback</a>) exceeds the speed limit defined by parameter <a href="#">30.11</a> or <a href="#">30.12</a> by more than the value of this parameter, the drive trips on the <a href="#">7310 Overspeed</a> fault.</p> <p> <b>WARNING!</b> This function only supervises the speed in vector motor control mode. The function is not effective in scalar motor control mode.</p> <p><b>Example:</b> If the maximum speed is 1420 rpm and speed trip margin is 300 rpm, the drive trips at 1720 rpm.</p> <p>Speed (<a href="#">24.02</a>)</p> 	500.00 rpm; 500.00 rpm ( <a href="#">95.20 b0</a> )
	0.00...10000.00 rpm	Overspeed trip margin.	See par. <a href="#">46.01</a>

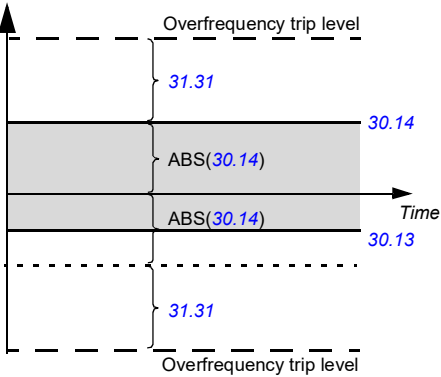
No.	Name/Value	Description	Def/FbEq16
31.31	<i>Frequency trip margin</i>	<p>Defines, together with <a href="#">30.13 Minimum frequency</a> and <a href="#">30.14 Maximum frequency</a>, the maximum allowed frequency of the motor (overfrequency protection). The absolute value of this overfrequency trip level is calculated by adding the value of this parameter to the higher of the absolute values of <a href="#">30.13 Minimum frequency</a> and <a href="#">30.14 Maximum frequency</a>.</p> <p>If the output frequency (<a href="#">01.06 Output frequency</a>) exceeds the overfrequency trip level (ie. the absolute value of the output frequency exceeds the absolute value of the overfrequency trip level), the drive trips on the <a href="#">73F0 Overfrequency</a> fault.</p> <p>Frequency</p> 	15.00 Hz
	0.00...10000.00 Hz	Overfrequency trip margin.	1 = 1 Hz
31.32	<i>Emergency ramp supervision</i>	<p>Parameters <a href="#">31.32 Emergency ramp supervision</a> and <a href="#">31.33 Emergency ramp supervision delay</a>, together with the derivative of <a href="#">24.02 Used speed feedback</a>, provide a supervision function for emergency stop modes Off1 and Off3.</p> <p>The supervision is based on either</p> <ul style="list-style-type: none"> <li>observing the time within which the motor stops, or</li> <li>comparing the actual and expected deceleration rates.</li> </ul> <p>If this parameter is set to 0%, the maximum stop time is directly set in parameter <a href="#">31.33</a>. Otherwise, <a href="#">31.32</a> defines the maximum allowed deviation from the expected deceleration rate, which is calculated from parameters <a href="#">23.11...23.15</a> (Off1) or <a href="#">23.23 Emergency stop time</a> (Off3). If the actual deceleration rate (<a href="#">24.02</a>) deviates too much from the expected rate, the drive trips on <a href="#">73B0 Emergency ramp failed</a>, sets bit 8 of <a href="#">06.17 Drive status word 2</a>, and coasts to a stop.</p> <p>If <a href="#">31.32</a> is set to 0% and <a href="#">31.33</a> is set to 0 s, the emergency stop ramp supervision is disabled.</p> <p>See also parameter <a href="#">21.04 Emergency stop mode</a>.</p>	0%
	0...300%	Maximum deviation from expected deceleration rate.	1 = 1%

## 318 Parameters

No.	Name/Value	Description	Def/FbEq16
31.33	<i>Emergency ramp supervision delay</i>	<p>If parameter <a href="#">31.32 Emergency ramp supervision</a> is set to 0%, this parameter defines the maximum time an emergency stop (mode Off1 or Off3) is allowed to take. If the motor has not stopped when the time elapses, the drive trips on <a href="#">73B0 Emergency ramp failed</a>, sets bit 8 of <a href="#">06.17 Drive status word 2</a>, and coasts to a stop.</p> <p>If <a href="#">31.32</a> is set to a value other than 0%, this parameter defines a delay between the receipt of the emergency stop command and the activation of the supervision. ABB recommends to specify a short delay to allow the speed change rate to stabilize.</p>	0 s
	0...100 s	Maximum ramp-down time, or supervision activation delay.	1 = 1 s
31.35	<i>Main fan fault function</i>	<p>Selects how the drive reacts when a main cooling fan speed problem is detected. For frame sizes R6 or larger only. An event is triggered according to the value of this parameter (fault, warning or no action)</p> <ul style="list-style-type: none"> <li>if the rotation speed signal from the fan is lower than the measured fan maximum speed (determined during the fan ID run)</li> <li>if the measured fan maximum speed is lower than the predefined minimum value.</li> </ul>	<i>Warning</i>
	Fault	Drive trips on fault <a href="#">5080 Fan</a> .	0
	Warning	Drive generates warning <a href="#">A581 Fan</a> .	1
	No action	No action taken.	2
31.36	<i>Aux fan fault function</i>	<p>Selects how the drive reacts when an auxiliary fan problem is detected.</p> <p>Certain drive types (especially those protected to IP55) have an auxiliary fan built into the front cover as standard. If it is necessary to operate the drive without the front cover (for example, during commissioning), you can set the parameter to value <i>No action</i> within two minutes from power-up to temporarily suppress the fault or warning. Return the value to <i>Fault</i> or <i>Warning</i> afterwards.</p> <p>On frame sizes R1...R5, the auxiliary fan is attached to connector X10 and on frame sizes R6 and larger to connector X16.</p>	<i>Warning</i>
	Fault	Drive trips on fault <a href="#">5081 Auxiliary fan broken</a> . The fault is suppressed for two minutes after power-up.	0
	Warning	Drive generates warning <a href="#">A582 Auxiliary fan missing</a> . The warning is suppressed for two minutes after power-up.	1
	No action	No action taken.	2

No.	Name/Value	Description	Def/FbEq16																								
31.40	<i>Disable warning messages</i>	Selects warnings to be suppressed. This parameter is a 16-bit word with each bit corresponding to a warning. Whenever a bit is set to 1, the corresponding warning is suppressed.	0000h																								
		<table border="1"> <thead> <tr> <th>Bit</th> <th>Name</th> <th>Description</th> </tr> </thead> <tbody> <tr> <td>0</td> <td>Reserved</td> <td></td> </tr> <tr> <td>1</td> <td>DC link undervoltage</td> <td>1 = Warning <i>A3A2 DC link undervoltage</i> is suppressed.</td> </tr> <tr> <td>2...4</td> <td>Reserved</td> <td></td> </tr> <tr> <td>5</td> <td>Emergency stop (off2)</td> <td>1 = Warning <i>AFE1 Emergency stop (off2)</i> is suppressed.</td> </tr> <tr> <td>6</td> <td>Emergency stop (off1 or off3)</td> <td>1 = Warning <i>AFE2 Emergency stop (off1 or off3)</i> is suppressed.</td> </tr> <tr> <td>7...15</td> <td>Reserved</td> <td></td> </tr> </tbody> </table>	Bit	Name	Description	0	Reserved		1	DC link undervoltage	1 = Warning <i>A3A2 DC link undervoltage</i> is suppressed.	2...4	Reserved		5	Emergency stop (off2)	1 = Warning <i>AFE1 Emergency stop (off2)</i> is suppressed.	6	Emergency stop (off1 or off3)	1 = Warning <i>AFE2 Emergency stop (off1 or off3)</i> is suppressed.	7...15	Reserved					
Bit	Name	Description																									
0	Reserved																										
1	DC link undervoltage	1 = Warning <i>A3A2 DC link undervoltage</i> is suppressed.																									
2...4	Reserved																										
5	Emergency stop (off2)	1 = Warning <i>AFE1 Emergency stop (off2)</i> is suppressed.																									
6	Emergency stop (off1 or off3)	1 = Warning <i>AFE2 Emergency stop (off1 or off3)</i> is suppressed.																									
7...15	Reserved																										
	0000h...FFFFh	Word for disabling warnings.	1 = 1																								
31.54	<i>Fault action</i>	Selects the stop mode when a non-critical fault occurs.	<i>Coast</i>																								
	Coast	Drive coasts to a stop.	0																								
	Emergency ramp	Drive follows the ramp specified for an emergency stop in parameter <i>23.23 Emergency stop time</i> .	1																								
<b>32 Supervision</b>		Configuration of signal supervision functions 1...6. Six values can be chosen to be monitored; a warning or fault is generated whenever predefined limits are exceeded. See also section <i>Signal supervision</i> (page 186).																									
32.01	<i>Supervision status</i>	Signal supervision status word. Indicates whether the values monitored by the signal supervision functions are within or outside their respective limits. <b>Note:</b> This word is independent of the drive actions defined by parameters <i>32.06</i> , <i>32.16</i> , <i>32.26</i> , <i>32.36</i> , <i>32.46</i> and <i>32.56</i> .	0000h																								
		<table border="1"> <thead> <tr> <th>Bit</th> <th>Name</th> <th>Description</th> </tr> </thead> <tbody> <tr> <td>0</td> <td>Supervision 1 active</td> <td>1 = Signal selected by <i>32.07</i> is outside its limits.</td> </tr> <tr> <td>1</td> <td>Supervision 2 active</td> <td>1 = Signal selected by <i>32.17</i> is outside its limits.</td> </tr> <tr> <td>2</td> <td>Supervision 3 active</td> <td>1 = Signal selected by <i>32.27</i> is outside its limits.</td> </tr> <tr> <td>3</td> <td>Supervision 4 active</td> <td>1 = Signal selected by <i>32.37</i> is outside its limits.</td> </tr> <tr> <td>4</td> <td>Supervision 5 active</td> <td>1 = Signal selected by <i>32.47</i> is outside its limits.</td> </tr> <tr> <td>5</td> <td>Supervision 6 active</td> <td>1 = Signal selected by <i>32.27</i> is outside its limits.</td> </tr> <tr> <td>6...15</td> <td>Reserved</td> <td></td> </tr> </tbody> </table>	Bit	Name	Description	0	Supervision 1 active	1 = Signal selected by <i>32.07</i> is outside its limits.	1	Supervision 2 active	1 = Signal selected by <i>32.17</i> is outside its limits.	2	Supervision 3 active	1 = Signal selected by <i>32.27</i> is outside its limits.	3	Supervision 4 active	1 = Signal selected by <i>32.37</i> is outside its limits.	4	Supervision 5 active	1 = Signal selected by <i>32.47</i> is outside its limits.	5	Supervision 6 active	1 = Signal selected by <i>32.27</i> is outside its limits.	6...15	Reserved		
Bit	Name	Description																									
0	Supervision 1 active	1 = Signal selected by <i>32.07</i> is outside its limits.																									
1	Supervision 2 active	1 = Signal selected by <i>32.17</i> is outside its limits.																									
2	Supervision 3 active	1 = Signal selected by <i>32.27</i> is outside its limits.																									
3	Supervision 4 active	1 = Signal selected by <i>32.37</i> is outside its limits.																									
4	Supervision 5 active	1 = Signal selected by <i>32.47</i> is outside its limits.																									
5	Supervision 6 active	1 = Signal selected by <i>32.27</i> is outside its limits.																									
6...15	Reserved																										
	0000h...FFFFh	Signal supervision status word.	1 = 1																								
32.05	<i>Supervision 1 function</i>	Selects the mode of signal supervision function 1. Determines how the monitored signal (see parameter <i>32.07</i> ) is compared to its lower and upper limits ( <i>32.09</i> and <i>32.10</i> respectively). The action to be taken when the condition is fulfilled is selected by <i>32.06</i> .	<i>Disabled</i>																								
	Disabled	Signal supervision 1 not in use.	0																								
	Low	Action is taken whenever the signal falls below its lower limit.	1																								
	High	Action is taken whenever the signal rises above its upper limit.	2																								

## 320 Parameters

No.	Name/Value	Description	Def/FbEq16
	Abs low	Action is taken whenever the absolute value of the signal falls below its (absolute) lower limit.	3
	Abs high	Action is taken whenever the absolute value of the signal rises above its (absolute) upper limit.	4
	Both	Action is taken whenever the signal falls below its low limit or rises above its high limit.	5
	Abs both	Action is taken whenever the absolute value of the signal falls below its (absolute) low limit or rises above its (absolute) high limit.	6
	Hysteresis	Action is taken whenever the signal rises above the value defined by the upper limit + 0.5 · hysteresis range ( <a href="#">32.11 Supervision 1 hysteresis</a> ). The action is deactivated when the signal falls below the value defined by the lower limit - 0.5 · hysteresis range.	7
<a href="#">32.06</a>	<a href="#">Supervision 1 action</a>	Selects whether the drive generates a fault, warning or neither when the value monitored by signal supervision 1 exceeds its limits. <b>Note:</b> This parameter does not affect the status indicated by <a href="#">32.01 Supervision status</a> .	<i>No action</i>
	No action	No warning or fault generated.	0
	Warning	Warning <a href="#">A8B0 ABB Signal supervision 1</a> is generated.	1
	Fault	Drive trips on fault <a href="#">80B0 Signal supervision 1</a> .	2
	Fault if running	If running, the drive trips on fault <a href="#">80B0 Signal supervision 1</a> .	3
<a href="#">32.07</a>	<a href="#">Supervision 1 signal</a>	Selects the signal to be monitored by signal supervision function 1.	<i>Frequency</i>
	Zero	None.	0
	Speed	<a href="#">01.01 Motor speed used</a> (page 199).	1
	Reserved		2
	Frequency	<a href="#">01.06 Output frequency</a> (page 199).	3
	Current	<a href="#">01.07 Motor current</a> (page 199).	4
	Reserved		5
	Torque	<a href="#">01.10 Motor torque</a> (page 199).	6
	DC voltage	<a href="#">01.11 DC voltage</a> (page 199).	7
	Output power	<a href="#">01.14 Output power</a> (page 200).	8
	AI1	<a href="#">12.11 AI1 actual value</a> (page 227).	9
	AI2	<a href="#">12.21 AI2 actual value</a> (page 229).	10
	Reserved		11...17
	Speed ref ramp in	<a href="#">23.01 Speed ref ramp input</a> (page 276).	18
	Speed ref ramp out	<a href="#">23.02 Speed ref ramp output</a> (page 276).	19
	Speed ref used	<a href="#">24.01 Used speed reference</a> (page 280).	20
	Torque ref used	<a href="#">26.02 Torque reference used</a> (page 286).	21
	Freq ref used	<a href="#">28.02 Frequency ref ramp output</a> (page 291).	22
	Inverter temperature	<a href="#">05.11 Inverter temperature</a> (page 205).	23
	Process PID output	<a href="#">40.01 Process PID output actual</a> (page 353).	24



No.	Name/Value	Description	Def/FbEq16
	Process PID feedback	<a href="#">40.02 Process PID feedback actual</a> (page 353).	25
	Process PID setpoint	<a href="#">40.03 Process PID setpoint actual</a> (page 353).	26
	Process PID deviation	<a href="#">40.04 Process PID deviation actual</a> (page 353).	27
	<i>Other</i>	Source selection (see <a href="#">Terms and abbreviations</a> on page 196).	-
<a href="#">32.08</a>	<a href="#">Supervision 1 filter time</a>	Defines a filter time constant for the signal monitored by signal supervision 1.	0.000 s
	0.000 ... 30.000 s	Signal filter time.	1000 = 1 s
<a href="#">32.09</a>	<a href="#">Supervision 1 low</a>	Defines the lower limit for signal supervision 1.	0.00
	-21474836.00... 21474836.00	Low limit.	-
<a href="#">32.10</a>	<a href="#">Supervision 1 high</a>	Defines the upper limit for signal supervision 1.	0.00
	-21474836.00... 21474836.00	Upper limit.	-
<a href="#">32.11</a>	<a href="#">Supervision 1 hysteresis</a>	Defines the hysteresis for the signal monitored by signal supervision 1. This parameter applies to all selections for parameter <a href="#">32.35 Supervision 4 function</a> , not just Hysteresis (selection 7). Action is taken whenever the signal rises above the value defined by the upper limit + 0.5 · hysteresis. The action is deactivated when the signal falls below the value defined by the lower limit - 0.5 · hysteresis.	0.00
	0.00...100000.00	Hysteresis.	-
<a href="#">32.15</a>	<a href="#">Supervision 2 function</a>	Selects the mode of signal supervision function 2. Determines how the monitored signal (see parameter <a href="#">32.17</a> ) is compared to its lower and upper limits ( <a href="#">32.19</a> and <a href="#">32.20</a> respectively). The action to be taken when the condition is fulfilled is selected by <a href="#">32.16</a> .	<i>Disabled</i>
	Disabled	Signal supervision 2 not in use.	0
	Low	Action is taken whenever the signal falls below its lower limit.	1
	High	Action is taken whenever the signal rises above its upper limit.	2
	Abs low	Action is taken whenever the absolute value of the signal falls below its (absolute) lower limit.	3
	Abs high	Action is taken whenever the absolute value of the signal rises above its (absolute) upper limit.	4
	Both	Action is taken whenever the signal falls below its low limit or rises above its high limit.	5
	Abs both	Action is taken whenever the absolute value of the signal falls below its (absolute) low limit or rises above its (absolute) high limit.	6
	Hysteresis	Action is taken whenever the signal rises above the value defined by the upper limit + 0.5 · hysteresis range ( <a href="#">32.21 Supervision 2 hysteresis</a> ). The action is deactivated when the signal falls below the value defined by the lower limit - 0.5 · hysteresis range.	7

## 322 Parameters

No.	Name/Value	Description	Def/FbEq16
32.16	<i>Supervision 2 action</i>	Selects whether the drive generates a fault, warning or neither when the value monitored by signal supervision 2 exceeds its limits. <b>Note:</b> This parameter does not affect the status indicated by <a href="#">32.01 Supervision status</a> .	<i>No action</i>
	No action	No warning or fault generated.	0
	Warning	Warning <a href="#">A8B1 ABB Signal supervision 2</a> is generated.	1
	Fault	Drive trips on fault <a href="#">80B1 Signal supervision 2</a> .	2
	Fault if running	If running, the drive trips on fault <a href="#">80B0 Signal supervision 1</a> .	3
32.17	<i>Supervision 2 signal</i>	Selects the signal to be monitored by signal supervision function 2. For the available selections, see parameter <a href="#">32.07 Supervision 1 signal</a> .	<i>Current</i>
32.18	<i>Supervision 2 filter time</i>	Defines a filter time constant for the signal monitored by signal supervision 2.	0.000 s
	0.000 ... 30.000 s	Signal filter time.	1000 = 1 s
32.19	<i>Supervision 2 low</i>	Defines the lower limit for signal supervision 2.	0.00
	-21474836.00... 21474836.00	Low limit.	-
32.20	<i>Supervision 2 high</i>	Defines the upper limit for signal supervision 2.	0.00
	-21474836.00... 21474836.00	Upper limit.	-
32.21	<i>Supervision 2 hysteresis</i>	Defines the hysteresis for the signal monitored by signal supervision 2. This parameter applies to all selections for parameter <a href="#">32.35 Supervision 4 function</a> , not just Hysteresis (selection 7). Action is taken whenever the signal rises above the value defined by the upper limit + 0.5 · hysteresis. The action is deactivated when the signal falls below the value defined by the lower limit - 0.5 · hysteresis.	0.00
	0.00...100000.00	Hysteresis.	-
32.25	<i>Supervision 3 function</i>	Selects the mode of signal supervision function 3. Determines how the monitored signal (see parameter <a href="#">32.27</a> ) is compared to its lower and upper limits ( <a href="#">32.29</a> and <a href="#">32.30</a> respectively). The action to be taken when the condition is fulfilled is selected by <a href="#">32.26</a> .	<i>Disabled</i>
	Disabled	Signal supervision 3 not in use.	0
	Low	Action is taken whenever the signal falls below its lower limit.	1
	High	Action is taken whenever the signal rises above its upper limit.	2
	Abs low	Action is taken whenever the absolute value of the signal falls below its (absolute) lower limit.	3
	Abs high	Action is taken whenever the absolute value of the signal rises above its (absolute) upper limit.	4
	Both	Action is taken whenever the signal falls below its low limit or rises above its high limit.	5
	Abs both	Action is taken whenever the absolute value of the signal falls below its (absolute) low limit or rises above its (absolute) high limit.	6

No.	Name/Value	Description	Def/FbEq16
	Hysteresis	Action is taken whenever the signal rises above the value defined by the upper limit + 0.5 · hysteresis range ( <a href="#">32.31 Supervision 3 hysteresis</a> ). The action is deactivated when the signal falls below the value defined by the lower limit - 0.5 · hysteresis range.	7
<a href="#">32.26</a>	<a href="#">Supervision 3 action</a>	Selects whether the drive generates a fault, warning or neither when the value monitored by signal supervision 3 exceeds its limits. <b>Note:</b> This parameter does not affect the status indicated by <a href="#">32.01 Supervision status</a> .	<i>No action</i>
	No action	No warning or fault generated.	0
	Warning	Warning <a href="#">ABB2 ABB Signal supervision 3</a> is generated.	1
	Fault	Drive trips on fault <a href="#">80B2 Signal supervision 3</a> .	2
	Fault if running	If running, the drive trips on fault <a href="#">80B0 Signal supervision 1</a> .	3
<a href="#">32.27</a>	<a href="#">Supervision 3 signal</a>	Selects the signal to be monitored by signal supervision function 3. For the available selections, see parameter <a href="#">32.07 Supervision 1 signal</a> .	<i>Torque</i>
<a href="#">32.28</a>	<a href="#">Supervision 3 filter time</a>	Defines a filter time constant for the signal monitored by signal supervision 3.	0.000 s
	0.000 ... 30.000 s	Signal filter time.	1000 = 1 s
<a href="#">32.29</a>	<a href="#">Supervision 3 low</a>	Defines the lower limit for signal supervision 3.	0.00
	-21474836.00... 21474836.00	Low limit.	-
<a href="#">32.30</a>	<a href="#">Supervision 3 high</a>	Defines the upper limit for signal supervision 3.	0.00
	-21474836.00... 21474836.00	Upper limit.	-
<a href="#">32.31</a>	<a href="#">Supervision 3 hysteresis</a>	Defines the hysteresis for the signal monitored by signal supervision 3. This parameter applies to all selections for parameter <a href="#">32.35 Supervision 4 function</a> , not just Hysteresis (selection 7). Action is taken whenever the signal rises above the value defined by the upper limit + 0.5 · hysteresis. The action is deactivated when the signal falls below the value defined by the lower limit - 0.5 · hysteresis.	0.00
	0.00...100000.00	Hysteresis.	-
<a href="#">32.35</a>	<a href="#">Supervision 4 function</a>	Selects the mode of signal supervision function 4. Determines how the monitored signal (see parameter <a href="#">32.37</a> ) is compared to its lower and upper limits ( <a href="#">32.39</a> and <a href="#">32.30</a> respectively). The action to be taken when the condition is fulfilled is selected by <a href="#">32.36</a> .	<i>Disabled</i>
	Disabled	Signal supervision 4 not in use.	0
	Low	Action is taken whenever the signal falls below its lower limit.	1
	High	Action is taken whenever the signal rises above its upper limit.	2
	Abs low	Action is taken whenever the absolute value of the signal falls below its (absolute) lower limit.	3
	Abs high	Action is taken whenever the absolute value of the signal rises above its (absolute) upper limit.	4

## 324 Parameters

No.	Name/Value	Description	Def/FbEq16
	Both	Action is taken whenever the signal falls below its low limit or rises above its high limit.	5
	Abs both	Action is taken whenever the absolute value of the signal falls below its (absolute) low limit or rises above its (absolute) high limit.	6
	Hysteresis	Action is taken whenever the signal rises above the value defined by the upper limit + 0.5 · hysteresis range ( <a href="#">32.41 Supervision 4 hysteresis</a> ). The action is deactivated when the signal falls below the value defined by the lower limit - 0.5 · hysteresis range.	7
<a href="#">32.36</a>	<a href="#">Supervision 4 action</a>	Selects whether the drive generates a fault, warning or neither when the value monitored by signal supervision 4 exceeds its limits. <b>Note:</b> This parameter does not affect the status indicated by <a href="#">32.01 Supervision status</a> .	<i>No action</i>
	No action	No warning or fault generated.	0
	Warning	Warning <a href="#">ABB3 ABB Signal supervision 4</a> is generated.	1
	Fault	Drive trips on fault <a href="#">80B3 Signal supervision 4</a> .	2
	Fault if running	Drive trips on fault <a href="#">80B0 Signal supervision 1</a> if the motor is running.	3
<a href="#">32.37</a>	<a href="#">Supervision 4 signal</a>	Selects the signal to be monitored by signal supervision function 4. For the available selections, see parameter <a href="#">32.07 Supervision 1 signal</a> .	<i>Zero</i>
<a href="#">32.38</a>	<a href="#">Supervision 4 filter time</a>	Defines a filter time constant for the signal monitored by signal supervision 4.	0.000 s
	0.000 ... 30.000 s	Signal filter time.	1000 = 1 s
<a href="#">32.39</a>	<a href="#">Supervision 4 low</a>	Defines the lower limit for signal supervision 4.	0.00
	-21474836.00... 21474836.00	Low limit.	-
<a href="#">32.40</a>	<a href="#">Supervision 4 high</a>	Defines the upper limit for signal supervision 4.	0.00
	-21474836.00... 21474836.00	Upper limit.	-
<a href="#">32.41</a>	<a href="#">Supervision 4 hysteresis</a>	Defines the hysteresis for the signal monitored by signal supervision 4. This parameter applies to all selections for parameter <a href="#">32.35 Supervision 4 function</a> , not just Hysteresis (selection 7). Action is taken whenever the signal rises above the value defined by the upper limit + 0.5 · hysteresis. The action is deactivated when the signal falls below the value defined by the lower limit - 0.5 · hysteresis.	0.00
	0.00...100000.00	Hysteresis.	-
<a href="#">32.45</a>	<a href="#">Supervision 5 function</a>	Selects the mode of signal supervision function 5. Determines how the monitored signal (see parameter <a href="#">32.47</a> ) is compared to its lower and upper limits ( <a href="#">32.49</a> and <a href="#">32.40</a> respectively). The action to be taken when the condition is fulfilled is selected by <a href="#">32.46</a> .	<i>Disabled</i>
	Disabled	Signal supervision 5 not in use.	0
	Low	Action is taken whenever the signal falls below its lower limit.	1
	High	Action is taken whenever the signal rises above its upper limit.	2

No.	Name/Value	Description	Def/FbEq16
	Abs low	Action is taken whenever the absolute value of the signal falls below its (absolute) lower limit.	3
	Abs high	Action is taken whenever the absolute value of the signal rises above its (absolute) upper limit.	4
	Both	Action is taken whenever the signal falls below its low limit or rises above its high limit.	5
	Abs both	Action is taken whenever the absolute value of the signal falls below its (absolute) low limit or rises above its (absolute) high limit.	6
	Hysteresis	Action is taken whenever the signal rises above the value defined by the upper limit + 0.5 · hysteresis range ( <a href="#">32.51 Supervision 5 hysteresis</a> ). The action is deactivated when the signal falls below the value defined by the lower limit - 0.5 · hysteresis range.	7
<a href="#">32.46</a>	<a href="#">Supervision 5 action</a>	Selects whether the drive generates a fault, warning or neither when the value monitored by signal supervision 5 exceeds its limits. <b>Note:</b> This parameter does not affect the status indicated by <a href="#">32.01 Supervision status</a> .	<i>No action</i>
	No action	No warning or fault generated.	0
	Warning	Warning <a href="#">A8B4 ABB Signal supervision 5</a> is generated.	1
	Fault	Drive trips on fault <a href="#">80B4 Signal supervision 5</a> .	2
	Fault if running	Drive trips on fault <a href="#">80B0 Signal supervision 1</a> if the motor is running.	3
<a href="#">32.47</a>	<a href="#">Supervision 5 signal</a>	Selects the signal to be monitored by signal supervision function 5. For the available selections, see parameter <a href="#">32.07 Supervision 1 signal</a> .	<i>Zero</i>
<a href="#">32.48</a>	<a href="#">Supervision 5 filter time</a>	Defines a filter time constant for the signal monitored by signal supervision 5.	0.000 s
	0.000 ... 30.000 s	Signal filter time.	1000 = 1 s
<a href="#">32.49</a>	<a href="#">Supervision 5 low</a>	Defines the lower limit for signal supervision 5.	0.00
	-21474836.00... 21474836.00	Low limit.	-
<a href="#">32.50</a>	<a href="#">Supervision 5 high</a>	Defines the upper limit for signal supervision 5.	0.00
	-21474836.00... 21474836.00	Upper limit.	-
<a href="#">32.51</a>	<a href="#">Supervision 5 hysteresis</a>	Defines the hysteresis for the signal monitored by signal supervision 5. This parameter applies to all selections for parameter <a href="#">32.35 Supervision 4 function</a> , not just Hysteresis (selection 7). Action is taken whenever the signal rises above the value defined by the upper limit + 0.5 · hysteresis. The action is deactivated when the signal falls below the value defined by the lower limit - 0.5 · hysteresis.	0.00
	0.00...100000.00	Hysteresis.	-

## 326 Parameters

No.	Name/Value	Description	Def/FbEq16
32.55	<i>Supervision 6 function</i>	Selects the mode of signal supervision function 6. Determines how the monitored signal (see parameter 32.57) is compared to its lower and upper limits (32.59 and 32.50 respectively). The action to be taken when the condition is fulfilled is selected by 32.56.	<i>Disabled</i>
	Disabled	Signal supervision 6 not in use.	0
	Low	Action is taken whenever the signal falls below its lower limit.	1
	High	Action is taken whenever the signal rises above its upper limit.	2
	Abs low	Action is taken whenever the absolute value of the signal falls below its (absolute) lower limit.	3
	Abs high	Action is taken whenever the absolute value of the signal rises above its (absolute) upper limit.	4
	Both	Action is taken whenever the signal falls below its low limit or rises above its high limit.	5
	Abs both	Action is taken whenever the absolute value of the signal falls below its (absolute) low limit or rises above its (absolute) high limit.	6
	Hysteresis	Action is taken whenever the signal rises above the value defined by the upper limit + 0.5 · hysteresis range (32.61 <i>Supervision 6 hysteresis</i> ). The action is deactivated when the signal falls below the value defined by the lower limit - 0.5 · hysteresis range.	7
32.56	<i>Supervision 6 action</i>	Selects whether the drive generates a fault, warning or neither when the value monitored by signal supervision 6 exceeds its limits. <b>Note:</b> This parameter does not affect the status indicated by 32.01 <i>Supervision status</i> .	<i>No action</i>
	No action	No warning or fault generated.	0
	Warning	Warning <i>ABB5 ABB Signal supervision 6</i> is generated.	1
	Fault	Drive trips on fault <i>80B5 Signal supervision 6</i> .	2
	Fault if running	Drive trips on fault <i>80B0 Signal supervision 1</i> if the motor is running.	3
32.57	<i>Supervision 6 signal</i>	Selects the signal to be monitored by signal supervision function 6. For the available selections, see parameter 32.07 <i>Supervision 1 signal</i> .	<i>Zero</i>
32.58	<i>Supervision 6 filter time</i>	Defines a filter time constant for the signal monitored by signal supervision 6.	0.000 s
	0.000 ... 30.000 s	Signal filter time.	1000 = 1 s
32.59	<i>Supervision 6 low</i>	Defines the lower limit for signal supervision 6.	0.00
	-21474836.00... 21474836.00	Low limit.	-
32.60	<i>Supervision 6 high</i>	Defines the upper limit for signal supervision 6.	0.00
	-21474836.00... 21474836.00	Upper limit.	-

No.	Name/Value	Description	Def/FbEq16																																										
32.61	<i>Supervision 6 hysteresis</i>	Defines the hysteresis for the signal monitored by signal supervision 6. This parameter applies to all selections for parameter <a href="#">32.35 Supervision 4 function</a> , not just Hysteresis (selection 7). Action is taken whenever the signal rises above the value defined by the upper limit + 0.5 · hysteresis. The action is deactivated when the signal falls below the value defined by the lower limit - 0.5 · hysteresis.	0.00																																										
	0.00...100000.00	Hysteresis.	-																																										
<b>34 Timed functions</b>		Configuration of the timed functions. See also section <a href="#">Timed functions</a> (page 149).																																											
34.01	<i>Timed functions status</i>	Status of the combined timers. The status of a combined timer is the logical OR of all timers connected to it. This parameter is read-only.	-																																										
<table border="1"> <thead> <tr> <th>Bit</th> <th>Name</th> <th>Description</th> </tr> </thead> <tbody> <tr> <td>0</td> <td>Timed function 1</td> <td>1 = Active.</td> </tr> <tr> <td>1</td> <td>Timed function 2</td> <td>1 = Active.</td> </tr> <tr> <td>2</td> <td>Timed function 3</td> <td>1 = Active.</td> </tr> <tr> <td>3...15</td> <td>Reserved</td> <td></td> </tr> </tbody> </table>				Bit	Name	Description	0	Timed function 1	1 = Active.	1	Timed function 2	1 = Active.	2	Timed function 3	1 = Active.	3...15	Reserved																												
Bit	Name	Description																																											
0	Timed function 1	1 = Active.																																											
1	Timed function 2	1 = Active.																																											
2	Timed function 3	1 = Active.																																											
3...15	Reserved																																												
	0000h...0FFFFh	Status of combined timers 1...3.	1 = 1																																										
34.02	<i>Timer status</i>	Status of timers 1...12. This parameter is read-only.	-																																										
<table border="1"> <thead> <tr> <th>Bit</th> <th>Name</th> <th>Description</th> </tr> </thead> <tbody> <tr> <td>0</td> <td>Timer 1</td> <td>1 = Active.</td> </tr> <tr> <td>1</td> <td>Timer 2</td> <td>1 = Active.</td> </tr> <tr> <td>2</td> <td>Timer 3</td> <td>1 = Active.</td> </tr> <tr> <td>3</td> <td>Timer 4</td> <td>1 = Active.</td> </tr> <tr> <td>4</td> <td>Timer 5</td> <td>1 = Active.</td> </tr> <tr> <td>5</td> <td>Timer 6</td> <td>1 = Active.</td> </tr> <tr> <td>6</td> <td>Timer 7</td> <td>1 = Active.</td> </tr> <tr> <td>7</td> <td>Timer 8</td> <td>1 = Active.</td> </tr> <tr> <td>8</td> <td>Timer 9</td> <td>1 = Active.</td> </tr> <tr> <td>9</td> <td>Timer 10</td> <td>1 = Active.</td> </tr> <tr> <td>10</td> <td>Timer 11</td> <td>1 = Active.</td> </tr> <tr> <td>11</td> <td>Timer 12</td> <td>1 = Active.</td> </tr> <tr> <td>12...15</td> <td>Reserved</td> <td></td> </tr> </tbody> </table>				Bit	Name	Description	0	Timer 1	1 = Active.	1	Timer 2	1 = Active.	2	Timer 3	1 = Active.	3	Timer 4	1 = Active.	4	Timer 5	1 = Active.	5	Timer 6	1 = Active.	6	Timer 7	1 = Active.	7	Timer 8	1 = Active.	8	Timer 9	1 = Active.	9	Timer 10	1 = Active.	10	Timer 11	1 = Active.	11	Timer 12	1 = Active.	12...15	Reserved	
Bit	Name	Description																																											
0	Timer 1	1 = Active.																																											
1	Timer 2	1 = Active.																																											
2	Timer 3	1 = Active.																																											
3	Timer 4	1 = Active.																																											
4	Timer 5	1 = Active.																																											
5	Timer 6	1 = Active.																																											
6	Timer 7	1 = Active.																																											
7	Timer 8	1 = Active.																																											
8	Timer 9	1 = Active.																																											
9	Timer 10	1 = Active.																																											
10	Timer 11	1 = Active.																																											
11	Timer 12	1 = Active.																																											
12...15	Reserved																																												
	0000h...FFFFh	Timer status.	1 = 1																																										

No.	Name/Value	Description	Def/FbEq16																											
34.04	<i>Season/exception day status</i>	Status of seasons 1...4, exception weekday and exception holiday. Only one season can be active at a time. A day can be a workday and a holiday at the same time. This parameter is read-only.	-																											
<table border="1"> <thead> <tr> <th>Bit</th> <th>Name</th> <th>Description</th> </tr> </thead> <tbody> <tr> <td>0</td> <td>Season 1</td> <td>1 = Active.</td> </tr> <tr> <td>1</td> <td>Season 2</td> <td>1 = Active.</td> </tr> <tr> <td>2</td> <td>Season 3</td> <td>1 = Active.</td> </tr> <tr> <td>3</td> <td>Season 4</td> <td>1 = Active.</td> </tr> <tr> <td>4...9</td> <td>Reserved</td> <td></td> </tr> <tr> <td>10</td> <td>Exception weekday</td> <td>1 = Active.</td> </tr> <tr> <td>11</td> <td>Exception holiday</td> <td>1 = Active.</td> </tr> <tr> <td>12...15</td> <td>Reserved</td> <td></td> </tr> </tbody> </table>				Bit	Name	Description	0	Season 1	1 = Active.	1	Season 2	1 = Active.	2	Season 3	1 = Active.	3	Season 4	1 = Active.	4...9	Reserved		10	Exception weekday	1 = Active.	11	Exception holiday	1 = Active.	12...15	Reserved	
Bit	Name	Description																												
0	Season 1	1 = Active.																												
1	Season 2	1 = Active.																												
2	Season 3	1 = Active.																												
3	Season 4	1 = Active.																												
4...9	Reserved																													
10	Exception weekday	1 = Active.																												
11	Exception holiday	1 = Active.																												
12...15	Reserved																													
	0000h...FFFFh	Status of the seasons and exception weekday and holiday.	1 = 1																											
34.10	<i>Timed functions enable</i>	Selects the source for the timed functions enable signal. 0 = Disabled. 1 = Enabled.	<i>Disabled</i>																											
	Disabled	0.	0																											
	Enabled	1.	1																											
	DI1	Digital input DI1 ( <i>10.02 DI delayed status</i> , bit 0).	2																											
	DI2	Digital input DI2 ( <i>10.02 DI delayed status</i> , bit 1).	3																											
	DI3	Digital input DI3 ( <i>10.02 DI delayed status</i> , bit 2).	4																											
	DI4	Digital input DI4 ( <i>10.02 DI delayed status</i> , bit 3).	5																											
	DI5	Digital input DI5 ( <i>10.02 DI delayed status</i> , bit 4).	6																											
	DI6	Digital input DI6 ( <i>10.02 DI delayed status</i> , bit 5).	7																											
	<i>Other [bit]</i>	Source selection (see <i>Terms and abbreviations</i> on page 196).	-																											



No.	Name/Value	Description	Def/FbEq16
34.11	<i>Timer 1 configuration</i>	Defines when timer 1 is active.	0000 0111 1000 0000b
<b>Bit</b>	<b>Name</b>	<b>Description</b>	
0	Monday	1 = Monday is an active start day.	
1	Tuesday	1 = Tuesday is an active start day.	
2	Wednesday	1 = Wednesday is an active start day.	
3	Thursday	1 = Thursday is an active start day.	
4	Friday	1 = Friday is an active start day.	
5	Saturday	1 = Saturday is an active start day.	
6	Sunday	1 = Sunday is an active start day.	
7	Season 1	1 = Timer is active in season 1.	
8	Season 2	1 = Timer is active in season 2.	
9	Season 3	1 = Timer is active in season 3.	
10	Season 4	1 = Timer is active in season 4.	
11	Exceptions	<p>0 = Exceptions days are disabled. The timer follows only weekday and season settings (bits 0...10 in the timer configuration) and the start time and duration of the timer (see 34.12 and 34.13).</p> <p>Exception day settings, parameters 34.70...34.90, do not have any effect on this timer.</p> <p>1 = Exception days are enabled. The timer is active during the weekdays and seasons defined with bits 0...10 and the times defined by 34.12 and 34.13.</p> <p>In addition, the timer is active during the exception days defined with bit 12, bit 13 and parameters 34.70...34.90. If bit 12 and bit 13 are both zero, the timer is inactive during the exception days.</p>	
12	Holidays	<p>This bit has no effect unless bit 11 = 1 (Exceptions days are enabled).</p> <p>When bits 11 and 12 are both 1, the timer is active during the weekdays and seasons defined with bits 0...10 and times defined by parameters 34.12 and 34.13.</p> <p>In addition, the timer is active when the ongoing day is defined as Exception day Holiday by parameters 34.70...34.90 and the current time matches with the time range defined by 34.12 and 34.13. During Exception days, weekday and season bits are ignored.</p>	
13	Workdays	<p>This bit has no effect unless bit 11 = 1 (Exceptions enabled).</p> <p>When bits 11 and 13 are both 1, the Timer is active during the weekdays and seasons defined with bits 0...10 and the times defined by parameters 34.12 and 34.13.</p> <p>In addition, the timer is active when the ongoing day is defined as Exception day Workday by parameters 34.70...34.90 and the current time matches with the time range defined by 34.12 and 34.13. During Exception days, weekday and season bits are ignored.</p>	
14...15	Reserved		

No.	Name/Value	Description	Def/FbEq16																																																																																																																							
Examples of how the timer configuration defines when the Timer is active are shown below.																																																																																																																										
<table border="1"> <thead> <tr> <th colspan="13" data-bbox="157 196 510 228">Bits of parameter</th> <th colspan="1" data-bbox="510 196 984 228"></th> </tr> <tr> <th data-bbox="157 228 180 384">Monday</th> <th data-bbox="180 228 202 384">Tuesday</th> <th data-bbox="202 228 225 384">Wednesday</th> <th data-bbox="225 228 247 384">Thursday</th> <th data-bbox="247 228 269 384">Friday</th> <th data-bbox="269 228 292 384">Saturday</th> <th data-bbox="292 228 314 384">Sunday</th> <th data-bbox="314 228 337 384">Season1</th> <th data-bbox="337 228 359 384">Season2</th> <th data-bbox="359 228 381 384">Season3</th> <th data-bbox="381 228 404 384">Season4</th> <th data-bbox="404 228 426 384">Exceptions</th> <th data-bbox="426 228 449 384">Holidays</th> <th data-bbox="449 228 510 384">Workdays</th> <th data-bbox="510 196 984 384"></th> </tr> </thead> <tbody> <tr> <td>1</td><td>1</td><td>1</td><td>1</td><td>1</td><td>1</td><td>1</td><td>1</td><td>1</td><td>1</td><td>1</td><td>0</td><td>0</td><td>0</td> <td data-bbox="510 384 984 496"> <b>Example 1:</b> Timer is active during the times of the day defined by other parameters <u>every Weekday</u> and <u>every Season</u>.                      Exception day settings (34.70...34.90) do not have any effect on the Timer.                 </td> </tr> <tr> <td>1</td><td>1</td><td>1</td><td>1</td><td>1</td><td>0</td><td>0</td><td>1</td><td>1</td><td>1</td><td>1</td><td>0</td><td>0</td><td>0</td> <td data-bbox="510 496 984 608"> <b>Example 2:</b> Timer is active during the times of the day defined by other parameters from <u>Mon to Fri</u>, every Season.                      Exception day settings (34.70...34.90) do not have any effect on the Timer.                 </td> </tr> <tr> <td>1</td><td>1</td><td>1</td><td>1</td><td>1</td><td>0</td><td>0</td><td>0</td><td>0</td><td>1</td><td>0</td><td>0</td><td>0</td><td>0</td> <td data-bbox="510 608 984 751"> <b>Example 3:</b> Timer is active during the times of the day defined by other parameters from Mon to Fri, <u>only during Season 3</u> (can be configured as, for example, summer).                      Exception day settings (34.70...34.90) do not have any effect on the Timer.                 </td> </tr> <tr> <td>1</td><td>1</td><td>1</td><td>1</td><td>1</td><td>0</td><td>0</td><td>1</td><td>1</td><td>1</td><td>1</td><td>1</td><td>1</td><td>0</td> <td data-bbox="510 751 984 863"> <b>Example 4:</b> Timer is active during the times of the day defined by other parameters from Mon to Fri, every Season.                      In addition, the Timer is active <u>every Exception day</u> <u>Holidays, regardless what is the day or season</u>.                 </td> </tr> <tr> <td>1</td><td>0</td><td>1</td><td>0</td><td>1</td><td>0</td><td>1</td><td>1</td><td>1</td><td>0</td><td>0</td><td>1</td><td>0</td><td>1</td> <td data-bbox="510 863 984 975"> <b>Example 5:</b> Timer is active during the times of the day defined by other parameters on Mon, Wed, Fri and Sun, during Season1 and Season 2.                      In addition, the Timer is active every <u>Exception day</u> <u>Workdays, regardless what is the day or season</u>.                 </td> </tr> <tr> <td>1</td><td>1</td><td>1</td><td>1</td><td>1</td><td>1</td><td>1</td><td>1</td><td>1</td><td>1</td><td>1</td><td>1</td><td>0</td><td>0</td> <td data-bbox="510 975 984 1086"> <b>Example 6:</b> Timer is active during the times of the day defined by other parameters every Weekday and every Season.                      The Timer is <u>inactive during all Exception days</u>.                 </td> </tr> </tbody> </table>				Bits of parameter														Monday	Tuesday	Wednesday	Thursday	Friday	Saturday	Sunday	Season1	Season2	Season3	Season4	Exceptions	Holidays	Workdays		1	1	1	1	1	1	1	1	1	1	1	0	0	0	<b>Example 1:</b> Timer is active during the times of the day defined by other parameters <u>every Weekday</u> and <u>every Season</u> . Exception day settings (34.70...34.90) do not have any effect on the Timer.	1	1	1	1	1	0	0	1	1	1	1	0	0	0	<b>Example 2:</b> Timer is active during the times of the day defined by other parameters from <u>Mon to Fri</u> , every Season. Exception day settings (34.70...34.90) do not have any effect on the Timer.	1	1	1	1	1	0	0	0	0	1	0	0	0	0	<b>Example 3:</b> Timer is active during the times of the day defined by other parameters from Mon to Fri, <u>only during Season 3</u> (can be configured as, for example, summer). Exception day settings (34.70...34.90) do not have any effect on the Timer.	1	1	1	1	1	0	0	1	1	1	1	1	1	0	<b>Example 4:</b> Timer is active during the times of the day defined by other parameters from Mon to Fri, every Season. In addition, the Timer is active <u>every Exception day</u> <u>Holidays, regardless what is the day or season</u> .	1	0	1	0	1	0	1	1	1	0	0	1	0	1	<b>Example 5:</b> Timer is active during the times of the day defined by other parameters on Mon, Wed, Fri and Sun, during Season1 and Season 2. In addition, the Timer is active every <u>Exception day</u> <u>Workdays, regardless what is the day or season</u> .	1	1	1	1	1	1	1	1	1	1	1	1	0	0	<b>Example 6:</b> Timer is active during the times of the day defined by other parameters every Weekday and every Season. The Timer is <u>inactive during all Exception days</u> .
Bits of parameter																																																																																																																										
Monday	Tuesday	Wednesday	Thursday	Friday	Saturday	Sunday	Season1	Season2	Season3	Season4	Exceptions	Holidays	Workdays																																																																																																													
1	1	1	1	1	1	1	1	1	1	1	0	0	0	<b>Example 1:</b> Timer is active during the times of the day defined by other parameters <u>every Weekday</u> and <u>every Season</u> . Exception day settings (34.70...34.90) do not have any effect on the Timer.																																																																																																												
1	1	1	1	1	0	0	1	1	1	1	0	0	0	<b>Example 2:</b> Timer is active during the times of the day defined by other parameters from <u>Mon to Fri</u> , every Season. Exception day settings (34.70...34.90) do not have any effect on the Timer.																																																																																																												
1	1	1	1	1	0	0	0	0	1	0	0	0	0	<b>Example 3:</b> Timer is active during the times of the day defined by other parameters from Mon to Fri, <u>only during Season 3</u> (can be configured as, for example, summer). Exception day settings (34.70...34.90) do not have any effect on the Timer.																																																																																																												
1	1	1	1	1	0	0	1	1	1	1	1	1	0	<b>Example 4:</b> Timer is active during the times of the day defined by other parameters from Mon to Fri, every Season. In addition, the Timer is active <u>every Exception day</u> <u>Holidays, regardless what is the day or season</u> .																																																																																																												
1	0	1	0	1	0	1	1	1	0	0	1	0	1	<b>Example 5:</b> Timer is active during the times of the day defined by other parameters on Mon, Wed, Fri and Sun, during Season1 and Season 2. In addition, the Timer is active every <u>Exception day</u> <u>Workdays, regardless what is the day or season</u> .																																																																																																												
1	1	1	1	1	1	1	1	1	1	1	1	0	0	<b>Example 6:</b> Timer is active during the times of the day defined by other parameters every Weekday and every Season. The Timer is <u>inactive during all Exception days</u> .																																																																																																												
0000h...FFFFh		Configuration of timer 1.	1 = 1																																																																																																																							
34.12	<i>Timer 1 start time</i>	Defines the daily start time of timer 1. The time can be changed in second steps. The timer can be started at an other time than the start time. For example, if the timer's duration is more than one day and the active session starts during the time, the timer is started at 00:00 and stopped when there is no duration left.	00:00:00																																																																																																																							
00:00:00...23:59:59		Daily start time of the timer.	1 = 1																																																																																																																							

No.	Name/Value	Description	Def/FbEq16
34.13	<i>Timer 1 duration</i>	Defines the duration of timer 1. The duration can be changed in minute steps. The duration can extend over the change of the day but if an exception day becomes active, the period is interrupted at midnight. In the same way the period started on an exception day stays active only until the end of the day, even if the duration is longer. The timer will continue after a break if there is duration left.	00 00:00
	00 00:00...07 00:00	Timer duration.	1 = 1
34.14	<i>Timer 2 configuration</i>	See <a href="#">34.11 Timer 1 configuration</a> .	0000 0111 1000 0000b
34.15	<i>Timer 2 start time</i>	See <a href="#">34.12 Timer 1 start time</a> .	00:00:00
34.16	<i>Timer 2 duration</i>	See <a href="#">34.13 Timer 1 duration</a> .	00 00:00
34.17	<i>Timer 3 configuration</i>	See <a href="#">34.11 Timer 1 configuration</a> .	0000 0111 1000 0000b
34.18	<i>Timer 3 start time</i>	See <a href="#">34.12 Timer 1 start time</a> .	00:00:00
34.19	<i>Timer 3 duration</i>	See <a href="#">34.13 Timer 1 duration</a> .	00 00:00
34.20	<i>Timer 4 configuration</i>	See <a href="#">34.11 Timer 1 configuration</a> .	0000 0111 1000 0000b
34.21	<i>Timer 4 start time</i>	See <a href="#">34.12 Timer 1 start time</a> .	00:00:00
34.22	<i>Timer 4 duration</i>	See <a href="#">34.13 Timer 1 duration</a> .	00 00:00
34.23	<i>Timer 5 configuration</i>	See <a href="#">34.11 Timer 1 configuration</a> .	0000 0111 1000 0000b
34.24	<i>Timer 5 start time</i>	See <a href="#">34.12 Timer 1 start time</a> .	00:00:00
34.25	<i>Timer 5 duration</i>	See <a href="#">34.13 Timer 1 duration</a> .	00 00:00
34.26	<i>Timer 6 configuration</i>	See <a href="#">34.11 Timer 1 configuration</a> .	0000 0111 1000 0000b
34.27	<i>Timer 6 start time</i>	See <a href="#">34.12 Timer 1 start time</a> .	00:00:00
34.28	<i>Timer 6 duration</i>	See <a href="#">34.13 Timer 1 duration</a> .	00 00:00
34.29	<i>Timer 7 configuration</i>	See <a href="#">34.11 Timer 1 configuration</a> .	0000 0111 1000 0000b
34.30	<i>Timer 7 start time</i>	See <a href="#">34.12 Timer 1 start time</a> .	00:00:00
34.31	<i>Timer 7 duration</i>	See <a href="#">34.13 Timer 1 duration</a> .	00 00:00
34.32	<i>Timer 8 configuration</i>	See <a href="#">34.11 Timer 1 configuration</a> .	0000 0111 1000 0000b
34.33	<i>Timer 8 start time</i>	See <a href="#">34.12 Timer 1 start time</a> .	00:00:00
34.34	<i>Timer 8 duration</i>	See <a href="#">34.13 Timer 1 duration</a> .	00 00:00
34.35	<i>Timer 9 configuration</i>	See <a href="#">34.11 Timer 1 configuration</a> .	0000 0111 1000 0000b
34.36	<i>Timer 9 start time</i>	See <a href="#">34.12 Timer 1 start time</a> .	00:00:00
34.37	<i>Timer 9 duration</i>	See <a href="#">34.13 Timer 1 duration</a> .	00 00:00
34.38	<i>Timer 10 configuration</i>	See <a href="#">34.11 Timer 1 configuration</a> .	0000 0111 1000 0000b
34.39	<i>Timer 10 start time</i>	See <a href="#">34.12 Timer 1 start time</a> .	00:00:00
34.40	<i>Timer 10 duration</i>	See <a href="#">34.13 Timer 1 duration</a> .	00 00:00
34.41	<i>Timer 11 configuration</i>	See <a href="#">34.11 Timer 1 configuration</a> .	0000 0111 1000 0000b

## 332 Parameters

No.	Name/Value	Description	Def/FbEq16
34.42	<i>Timer 11 start time</i>	See <a href="#">34.12 Timer 1 start time</a> .	00:00:00
34.43	<i>Timer 11 duration</i>	See <a href="#">34.13 Timer 1 duration</a> .	00 00:00
34.44	<i>Timer 12 configuration</i>	See <a href="#">34.11 Timer 1 configuration</a> .	0000 0111 1000 0000b
34.45	<i>Timer 12 start time</i>	See <a href="#">34.12 Timer 1 start time</a> .	00:00:00
34.46	<i>Timer 12 duration</i>	See <a href="#">34.13 Timer 1 duration</a> .	00 00:00
34.60	<i>Season 1 start date</i>	Defines the start date of season 1 in format dd.mm, where dd is the number of the day and mm is the number of the month. The season changes at midnight. One season can be active at a time. Timers are started on exception days even if they are not inside the active season. The season start dates (1...4) must be given in increasing order to use all seasons. The default value is interpreted that the season is not configured. If the season start dates are not in increasing order and the value is something else than the default value, a season configuration warning is given.	01.01.
	01.01...31.12	Season start date.	
34.61	<i>Season 2 start date</i>	Defines the start date of season 2. See <a href="#">34.60 Season 1 start date</a> .	01.01.
34.62	<i>Season 3 start date</i>	Defines the start date of season 3. See <a href="#">34.60 Season 1 start date</a> .	01.01.
34.63	<i>Season 4 start date</i>	Defines the start date of season 4. See <a href="#">34.60 Season 1 start date</a> .	01.01.
34.70	<i>Number of active exceptions</i>	Defines how many of the exceptions are active by specifying the last active one. All preceding exceptions are active. Exceptions 1...3 are periods (duration can be defined) and exceptions 4...16 are days (duration is always 24 hours). <b>Example:</b> If the value is 4, exceptions 1...4 are active, and exceptions 5...16 are not active.	3
	0...16	Number of active exception periods or days.	-

No.	Name/Value	Description	Def/FbEq16																																																			
34.71	<a href="#">Exception types</a>	Defines the types of exceptions 1...16 as workday or holiday. Exceptions 1...3 are periods (duration can be defined) and exceptions 4...16 are days (duration is always 24 hours).	0000h																																																			
		<table border="1"> <thead> <tr> <th>Bit</th> <th>Name</th> <th>Description</th> </tr> </thead> <tbody> <tr><td>0</td><td>Exception 1</td><td>0 = Workday. 1 = Holiday</td></tr> <tr><td>1</td><td>Exception 2</td><td>0 = Workday. 1 = Holiday</td></tr> <tr><td>2</td><td>Exception 3</td><td>0 = Workday. 1 = Holiday</td></tr> <tr><td>3</td><td>Exception 4</td><td>0 = Workday. 1 = Holiday</td></tr> <tr><td>4</td><td>Exception 5</td><td>0 = Workday. 1 = Holiday</td></tr> <tr><td>5</td><td>Exception 6</td><td>0 = Workday. 1 = Holiday</td></tr> <tr><td>6</td><td>Exception 7</td><td>0 = Workday. 1 = Holiday</td></tr> <tr><td>7</td><td>Exception 8</td><td>0 = Workday. 1 = Holiday</td></tr> <tr><td>8</td><td>Exception 9</td><td>0 = Workday. 1 = Holiday</td></tr> <tr><td>9</td><td>Exception 10</td><td>0 = Workday. 1 = Holiday</td></tr> <tr><td>10</td><td>Exception 11</td><td>0 = Workday. 1 = Holiday</td></tr> <tr><td>11</td><td>Exception 12</td><td>0 = Workday. 1 = Holiday</td></tr> <tr><td>12</td><td>Exception 13</td><td>0 = Workday. 1 = Holiday</td></tr> <tr><td>13</td><td>Exception 14</td><td>0 = Workday. 1 = Holiday</td></tr> <tr><td>14</td><td>Exception 15</td><td>0 = Workday. 1 = Holiday</td></tr> <tr><td>15</td><td>Exception 16</td><td>0 = Workday. 1 = Holiday</td></tr> </tbody> </table>	Bit	Name	Description	0	Exception 1	0 = Workday. 1 = Holiday	1	Exception 2	0 = Workday. 1 = Holiday	2	Exception 3	0 = Workday. 1 = Holiday	3	Exception 4	0 = Workday. 1 = Holiday	4	Exception 5	0 = Workday. 1 = Holiday	5	Exception 6	0 = Workday. 1 = Holiday	6	Exception 7	0 = Workday. 1 = Holiday	7	Exception 8	0 = Workday. 1 = Holiday	8	Exception 9	0 = Workday. 1 = Holiday	9	Exception 10	0 = Workday. 1 = Holiday	10	Exception 11	0 = Workday. 1 = Holiday	11	Exception 12	0 = Workday. 1 = Holiday	12	Exception 13	0 = Workday. 1 = Holiday	13	Exception 14	0 = Workday. 1 = Holiday	14	Exception 15	0 = Workday. 1 = Holiday	15	Exception 16	0 = Workday. 1 = Holiday	
Bit	Name	Description																																																				
0	Exception 1	0 = Workday. 1 = Holiday																																																				
1	Exception 2	0 = Workday. 1 = Holiday																																																				
2	Exception 3	0 = Workday. 1 = Holiday																																																				
3	Exception 4	0 = Workday. 1 = Holiday																																																				
4	Exception 5	0 = Workday. 1 = Holiday																																																				
5	Exception 6	0 = Workday. 1 = Holiday																																																				
6	Exception 7	0 = Workday. 1 = Holiday																																																				
7	Exception 8	0 = Workday. 1 = Holiday																																																				
8	Exception 9	0 = Workday. 1 = Holiday																																																				
9	Exception 10	0 = Workday. 1 = Holiday																																																				
10	Exception 11	0 = Workday. 1 = Holiday																																																				
11	Exception 12	0 = Workday. 1 = Holiday																																																				
12	Exception 13	0 = Workday. 1 = Holiday																																																				
13	Exception 14	0 = Workday. 1 = Holiday																																																				
14	Exception 15	0 = Workday. 1 = Holiday																																																				
15	Exception 16	0 = Workday. 1 = Holiday																																																				
	0000h...FFFFh	Types of exception period or days.	1 = 1																																																			
34.72	<a href="#">Exception 1 start</a>	Defines the start date of the exception period in format dd.mm, where dd is the number of the day and mm is the number of the month. The timer started on an exception day is always stopped at 23:59:59 even if it has duration left. The same date can be configured to be holiday and workday. The date is active if any of exception days are active.	01.01.																																																			
	01.01....31.12.	Start date of exception period 1.																																																				
34.73	<a href="#">Exception 1 length</a>	Defines the length of the exception period in days. Exception period is handled the same as a number of consecutive exception days.	0 days																																																			
	0...60 d	Length of exception period 1.	1 = 1																																																			
34.74	<a href="#">Exception 2 start</a>	See <a href="#">34.72 Exception 1 start</a> .	01.01.																																																			
34.75	<a href="#">Exception 2 length</a>	See <a href="#">34.73 Exception 1 length</a> .	0 days																																																			
34.76	<a href="#">Exception 3 start</a>	See <a href="#">34.72 Exception 1 start</a> .	01.01.																																																			
34.77	<a href="#">Exception 3 length</a>	See <a href="#">34.73 Exception 1 length</a> .	0 days																																																			
34.78	<a href="#">Exception day 4</a>	Defines the date of exception day 4.	01.01.																																																			
	01.01....31.12.	Start date of exception day 4. The timer started on an exception day is always stopped at 23:59:59 even if it has duration left.																																																				
34.79	<a href="#">Exception day 5</a>	See <a href="#">34.79 Exception day 4</a> .	01.01																																																			
34.80	<a href="#">Exception day 6</a>	See <a href="#">34.79 Exception day 4</a> .	01.01																																																			
34.81	<a href="#">Exception day 7</a>	See <a href="#">34.79 Exception day 4</a>	01.01																																																			
34.82	<a href="#">Exception day 8</a>	See <a href="#">34.79 Exception day 4</a> .	01.01																																																			

No.	Name/Value	Description	Def/FbEq16																																										
34.83	<a href="#">Exception day 9</a>	See <a href="#">34.79 Exception day 4</a> .	01.01																																										
34.84	<a href="#">Exception day 10</a>	See <a href="#">34.79 Exception day 4</a> .	01.01																																										
34.85	<a href="#">Exception day 11</a>	See <a href="#">34.79 Exception day 4</a> .	01.01																																										
34.86	<a href="#">Exception day 12</a>	See <a href="#">34.79 Exception day 4</a> .	01.01																																										
34.87	<a href="#">Exception day 13</a>	See <a href="#">34.79 Exception day 4</a> .	01.01																																										
34.88	<a href="#">Exception day 14</a>	See <a href="#">34.79 Exception day 4</a> .	01.01																																										
34.89	<a href="#">Exception day 15</a>	See <a href="#">34.79 Exception day 4</a> .	01.01																																										
34.90	<a href="#">Exception day 16</a>	See <a href="#">34.79 Exception day 4</a> .	01.01																																										
34.100	<a href="#">Timed function 1</a>	Defines which timers are connected to combined timer 1. 0 = Not connected. 1 = Connected. See <a href="#">34.01 Timed functions status</a> .	0000h																																										
<table border="1"> <thead> <tr> <th>Bit</th> <th>Name</th> <th>Description</th> </tr> </thead> <tbody> <tr> <td>0</td> <td>Timer 1</td> <td>0 = Inactive. 1 = Active.</td> </tr> <tr> <td>1</td> <td>Timer 2</td> <td>0 = Inactive. 1 = Active.</td> </tr> <tr> <td>2</td> <td>Timer 3</td> <td>0 = Inactive. 1 = Active.</td> </tr> <tr> <td>3</td> <td>Timer 4</td> <td>0 = Inactive. 1 = Active.</td> </tr> <tr> <td>4</td> <td>Timer 5</td> <td>0 = Inactive. 1 = Active.</td> </tr> <tr> <td>5</td> <td>Timer 6</td> <td>0 = Inactive. 1 = Active.</td> </tr> <tr> <td>6</td> <td>Timer 7</td> <td>0 = Inactive. 1 = Active.</td> </tr> <tr> <td>7</td> <td>Timer 8</td> <td>0 = Inactive. 1 = Active.</td> </tr> <tr> <td>8</td> <td>Timer 9</td> <td>0 = Inactive. 1 = Active.</td> </tr> <tr> <td>9</td> <td>Timer 10</td> <td>0 = Inactive. 1 = Active.</td> </tr> <tr> <td>10</td> <td>Timer 11</td> <td>0 = Inactive. 1 = Active.</td> </tr> <tr> <td>11</td> <td>Timer 12</td> <td>0 = Inactive. 1 = Active.</td> </tr> <tr> <td>12...15</td> <td>Reserved</td> <td></td> </tr> </tbody> </table>				Bit	Name	Description	0	Timer 1	0 = Inactive. 1 = Active.	1	Timer 2	0 = Inactive. 1 = Active.	2	Timer 3	0 = Inactive. 1 = Active.	3	Timer 4	0 = Inactive. 1 = Active.	4	Timer 5	0 = Inactive. 1 = Active.	5	Timer 6	0 = Inactive. 1 = Active.	6	Timer 7	0 = Inactive. 1 = Active.	7	Timer 8	0 = Inactive. 1 = Active.	8	Timer 9	0 = Inactive. 1 = Active.	9	Timer 10	0 = Inactive. 1 = Active.	10	Timer 11	0 = Inactive. 1 = Active.	11	Timer 12	0 = Inactive. 1 = Active.	12...15	Reserved	
Bit	Name	Description																																											
0	Timer 1	0 = Inactive. 1 = Active.																																											
1	Timer 2	0 = Inactive. 1 = Active.																																											
2	Timer 3	0 = Inactive. 1 = Active.																																											
3	Timer 4	0 = Inactive. 1 = Active.																																											
4	Timer 5	0 = Inactive. 1 = Active.																																											
5	Timer 6	0 = Inactive. 1 = Active.																																											
6	Timer 7	0 = Inactive. 1 = Active.																																											
7	Timer 8	0 = Inactive. 1 = Active.																																											
8	Timer 9	0 = Inactive. 1 = Active.																																											
9	Timer 10	0 = Inactive. 1 = Active.																																											
10	Timer 11	0 = Inactive. 1 = Active.																																											
11	Timer 12	0 = Inactive. 1 = Active.																																											
12...15	Reserved																																												
0000h...FFFFh		Timers connected to combined timer 1.	1 = 1																																										
34.101	<a href="#">Timed function 2</a>	Defines which timers are connected to combined timer 2. See <a href="#">34.01 Timed functions status</a> .	0000h																																										
34.102	<a href="#">Timed function 3</a>	Defines which timers are connected to combined timer 3. See <a href="#">34.01 Timed functions status</a> .	0000h																																										
34.110	<a href="#">Boost time function</a>	Defines which combined timers (that is, timers that are connected to the combined timers) are activated with the extra time function.	0000h																																										
<table border="1"> <thead> <tr> <th>Bit</th> <th>Name</th> <th>Description</th> </tr> </thead> <tbody> <tr> <td>0</td> <td>Timed function 1</td> <td>0 = Inactive. 1 = Active.</td> </tr> <tr> <td>1</td> <td>Timed function 2</td> <td>0 = Inactive. 1 = Active.</td> </tr> <tr> <td>2</td> <td>Timed function 3</td> <td>0 = Inactive. 1 = Active.</td> </tr> <tr> <td>3...15</td> <td>Reserved</td> <td></td> </tr> </tbody> </table>				Bit	Name	Description	0	Timed function 1	0 = Inactive. 1 = Active.	1	Timed function 2	0 = Inactive. 1 = Active.	2	Timed function 3	0 = Inactive. 1 = Active.	3...15	Reserved																												
Bit	Name	Description																																											
0	Timed function 1	0 = Inactive. 1 = Active.																																											
1	Timed function 2	0 = Inactive. 1 = Active.																																											
2	Timed function 3	0 = Inactive. 1 = Active.																																											
3...15	Reserved																																												
0000h...FFFFh		Combined timers including the extra timer.	1 = 1																																										

No.	Name/Value	Description	Def/FbEq16
<b>34.111</b>	<b>Boost time activation source</b>	Selects the source of extra time activation signal. 0 = Disabled. 1 = Enabled.	<i>Off</i>
	Off	0.	0
	On	1.	1
	DI1	Digital input DI1 ( <i>10.02 DI delayed status</i> , bit 0).	2
	DI2	Digital input DI2 ( <i>10.02 DI delayed status</i> , bit 1).	3
	DI3	Digital input DI3 ( <i>10.02 DI delayed status</i> , bit 2).	4
	DI4	Digital input DI4 ( <i>10.02 DI delayed status</i> , bit 3).	5
	DI5	Digital input DI5 ( <i>10.02 DI delayed status</i> , bit 4).	6
	DI6	Digital input DI6 ( <i>10.02 DI delayed status</i> , bit 5).	7
	<i>Other [bit]</i>	Source selection (see <i>Terms and abbreviations</i> on page 196).	-
<b>34.112</b>	<b>Boost time duration</b>	Defines the time inside which the extra time is deactivated after extra time activation signal is switched off. <b>Example:</b> If parameter <i>34.111 Boost time activation source</i> is set to <i>DI1</i> and <i>34.112 Boost time duration</i> is set to 00 01:30, the extra time is active for 1 hour and 30 minutes after digital input DI is deactivated.	00 00:00
	00 00:00...07 00:00	Extra time duration.	1 = 1
<b>35 Motor thermal protection</b>		Motor thermal protection settings such as temperature measurement configuration, load curve definition and motor fan control configuration. See also section <i>Motor thermal protection</i> (page 177).	
<b>35.01</b>	<b>Motor estimated temperature</b>	Displays the motor temperature as estimated by the internal motor thermal protection model (see parameters <i>35.50...35.55</i> ). The unit is selected by parameter <i>96.16 Unit selection</i> . This parameter is read-only.	-
	-60...1000 °C or -76...1832 °F	Estimated motor temperature.	1 = 1°
<b>35.02</b>	<b>Measured temperature 1</b>	Displays the temperature received through the source defined by parameter <i>35.11 Temperature 1 source</i> . The unit is selected by parameter <i>96.16 Unit selection</i> . <b>Notes:</b> • With a PTC sensor, the unit is ohms. • With a PTC sensor connected DI6, the value shown is not a valid measurement. Either 0 ohm (normal temperature) or the value of parameter <i>35.12 Temperature 1 fault limit</i> (excessive temperature) is shown. This parameter is read-only.	-
	-60...5000 °C or -76...9032 °F, 0...5000 ohm or [35.12] ohm	Measured temperature 1.	1 = 1 unit

## 336 Parameters

No.	Name/Value	Description	Def/FbEq16
35.03	<i>Measured temperature 2</i>	Displays the temperature received through the source defined by parameter <a href="#">35.21 Temperature 2 source</a> . The unit is selected by parameter <a href="#">96.16 Unit selection</a> . <b>Notes:</b> <ul style="list-style-type: none"> <li>With a PTC sensor, the unit is ohms.</li> <li>With a PTC sensor connected DI6, the value shown is not a valid measurement. Either 0 ohm (normal temperature) or the value of parameter <a href="#">35.12 Temperature 1 fault limit</a> (excessive temperature) is shown.</li> </ul> This parameter is read-only.	-
	-60...5000 °C or -76...9032 °F, 0...5000 ohm or <a href="#">[35.22]</a> ohm	Measured temperature 2.	1 = 1 unit
35.05	<i>Motor overload level</i>	Shows the motor overload level as a percent of the motor overload fault limit. See parameter <a href="#">35.56 Motor overload action</a> and section <a href="#">Motor overload protection</a> (page 182).	0.0
	0.0...300.0%	Motor overload level. 0.0% No motor overloading 88.0% Motor overloaded to warning level 100.0% Motor overloaded to fault level	10 = 1%
35.11	<i>Temperature 1 source</i>	Selects the source from which measured temperature 1 is read. Usually this source is from a sensor connected to the motor controlled by the drive, but it could be used to measure and monitor a temperature from other parts of the process as long as a suitable sensor is used as per the selection list.	<i>Estimated temperature</i>
	Disabled	None. Temperature monitoring function 1 is disabled.	0
	Estimated temperature	Estimated motor temperature (see parameter <a href="#">35.01 Motor estimated temperature</a> ). The temperature is estimated from an internal drive calculation. It is important to set up the ambient temperature of the motor in <a href="#">35.50 Motor ambient temperature</a> .	1
	KTY84 analog I/O	KTY84 sensor connected to the analog input selected by parameter <a href="#">35.14 Temperature 1 AI source</a> and an analog output. The following settings are required: <ul style="list-style-type: none"> <li>Set the hardware jumper or switch related to the analog input to <b>U</b> (voltage). Any change must be validated by a control unit reboot.</li> <li>Set the appropriate analog input unit selection parameter in group <a href="#">12 Standard AI</a> to <b>V</b> (volt).</li> <li>In parameter group <a href="#">13 Standard AO</a>, set the source selection parameter of the analog output to <a href="#">Temp sensor 1 excitation</a>.</li> </ul> The analog output feeds a constant current through the sensor. As the resistance of the sensor increases along with its temperature, the voltage over the sensor increases. The voltage is read by the analog input and converted into degrees.	2
	Reserved		3...4



No.	Name/Value	Description	Def/FbEq16
	1 × Pt100 analog I/O	<p>Pt100 sensor connected to a standard analog input selected by parameter <a href="#">35.14 Temperature 1 AI source</a> and an analog output.</p> <p>The following settings are required:</p> <ul style="list-style-type: none"> <li>• Set the hardware jumper or switch related to the analog input to <b>U</b> (voltage). Any change must be validated by a control unit reboot.</li> <li>• Set the appropriate analog input unit selection parameter in group <a href="#">12 Standard AI</a> to <b>V</b> (volt).</li> <li>• In parameter group <a href="#">13 Standard AO</a>, set the source selection parameter of the analog output to <a href="#">Temp sensor 1 excitation</a>.</li> </ul> <p>The analog output feeds a constant current through the sensor. As the resistance of the sensor increases along with its temperature, the voltage over the sensor increases. The voltage is read by the analog input and converted into degrees.</p>	5
	2 × Pt100 analog I/O	As selection <a href="#">1 × Pt100 analog I/O</a> , but with two sensors connected in series. Using multiple sensors improves measurement accuracy significantly.	6
	3 × Pt100 analog I/O	As selection <a href="#">1 × Pt100 analog I/O</a> , but with three sensors connected in series. Using multiple sensors improves measurement accuracy significantly.	7
	PTC DI6	<p>PTC sensor is connected to DI6.</p> <p><b>Note:</b> With a PTC sensor connected DI6, the value shown is not a valid measurement. Either 0 ohm (normal temperature) or the value of parameter <a href="#">35.22 Temperature 2 fault limit</a> (excessive temperature) is shown.</p>	8
	Reserved		9...10
	Direct temperature	The temperature is taken from the source selected by parameter <a href="#">35.14 Temperature 1 AI source</a> . The value of the source is assumed to be in the unit of temperature specified by parameter <a href="#">96.16 Unit selection</a> .	11
	KTY83 analog I/O	<p>KTY83 sensor connected to the analog input selected by parameter <a href="#">35.14 Temperature 1 AI source</a> and an analog output.</p> <p>The following settings are required:</p> <ul style="list-style-type: none"> <li>• Set the hardware jumper or switch related to the analog input to <b>U</b> (voltage). Any change must be validated by a control unit reboot.</li> <li>• Set the appropriate analog input unit selection parameter in group <a href="#">12 Standard AI</a> to <b>V</b> (volt).</li> <li>• In parameter group <a href="#">13 Standard AO</a>, set the source selection parameter of the analog output to <a href="#">Temp sensor 1 excitation</a>.</li> </ul> <p>The analog output feeds a constant current through the sensor. As the resistance of the sensor increases along with its temperature, the voltage over the sensor increases. The voltage is read by the analog input and converted into degrees.</p>	12

No.	Name/Value	Description	Def/FbEq16
	1 × Pt1000 analog I/O	<p>Pt1000 sensor connected to a standard analog input selected by parameter <a href="#">35.14 Temperature 1 AI source</a> and an analog output.</p> <p>The following settings are required:</p> <ul style="list-style-type: none"> <li>Set the hardware jumper or switch related to the analog input to <b>U</b> (voltage). Any change must be validated by a control unit reboot.</li> <li>Set the appropriate analog input unit selection parameter in group <a href="#">12 Standard AI</a> to <b>V</b> (volt).</li> <li>In parameter group <a href="#">13 Standard AO</a>, set the source selection parameter of the analog output to <a href="#">Temp sensor 1 excitation</a>.</li> </ul> <p>The analog output feeds a constant current through the sensor. As the resistance of the sensor increases along with its temperature, the voltage over the sensor increases. The voltage is read by the analog input and converted into degrees.</p>	13
	2 × Pt1000 analog I/O	As selection <a href="#">1 × Pt1000 analog I/O</a> , but with two sensors connected in series. Using multiple sensors improves measurement accuracy significantly.	14
	3 × Pt1000 analog I/O	As selection <a href="#">1 × Pt1000 analog I/O</a> , but with three sensors connected in series. Using multiple sensors improves measurement accuracy significantly.	15
	Ni1000	<p>Ni1000 sensor connected to the analog input selected by parameter <a href="#">35.14 Temperature 1 AI source</a> and an analog output.</p> <p>Sensors with thermal coefficient 6.18 ohm / 1 °C (6180 ppm/K) are supported. 100 °C corresponds to 1618 ohm.</p> <p>The following settings are required:</p> <ul style="list-style-type: none"> <li>Set the hardware jumper or switch related to the analog input to <b>U</b> (voltage). Any change must be validated by a control unit reboot.</li> <li>Set the appropriate analog input unit selection parameter in group <a href="#">12 Standard AI</a> to <b>V</b> (volt).</li> <li>In parameter group <a href="#">13 Standard AO</a>, set the source selection parameter of the analog output to <a href="#">Temp sensor 1 excitation</a>.</li> </ul> <p>The analog output feeds a constant current through the sensor. As the resistance of the sensor increases along with its temperature, the voltage over the sensor increases. The voltage is read by the analog input and converted into degrees.</p>	16
	Reserved		17...18
	PTC extension module	PTC is connected to the CMOD-02 multifunction extension module, which is installed in drive slot 2. See chapter <i>Optional I/O extension modules, section CMOD-02 multifunction extension module (external 24 V AC/DC and isolated PTC interface)</i> in the <i>Hardware manual</i> of the drive).	19
	PTC analog I/O	<p>PTC sensor connected to analog input selected by parameter <a href="#">35.14 Temperature 1 AI source</a> and an analog output.</p> <p>The required settings are the same as with selection <a href="#">KTY84 analog I/O</a>.</p> <p><b>Note:</b> With this selection, the control program converts the analog signal to PTC resistance value in ohms and shows it in parameter <a href="#">35.02</a>. The parameter name and unit still refer to temperature.</p>	20

No.	Name/Value	Description	Def/FbEq16
	Therm(0)	PTC sensor or a normally closed thermistor connected relay to digital input DI6. The motor is overheated when the digital input is 0.	21
	Therm(1)	Normally open thermistor relay connected to digital input DI6. The motor is overheated when the digital input is 1.	22
35.12	<i>Temperature 1 fault limit</i>	Defines the fault limit for temperature supervision function 1. When measured temperature 1 exceeds the limit, the drive trips on fault <a href="#">4981 External temperature 1</a> . The unit is selected by parameter <a href="#">96.16 Unit selection</a> . <b>Notes:</b> <ul style="list-style-type: none"> <li>With a PTC sensor, the unit is ohms.</li> <li>With a PTC sensor connected DI6, the value shown is not a valid measurement. Either 0 ohm (normal temperature) or the value of parameter <a href="#">35.12 Temperature 1 fault limit</a> (excessive temperature) is shown.</li> <li>With a PTC sensor, changing the value of this parameter has no effect on fault generation. When PTC is over the triggering threshold of the CMOD-02 (see the <i>Hardware manual of the drive</i>), the drive trips on the fault and when PTC has decreased below recovery threshold of the CMOD-02 (see the <i>Hardware manual of the drive</i>), the fault can be reset manually.</li> </ul>	130 °C or 266 °F or 4500 ohm
	-60...5000 °C or -76...9032 °F or 0...5000 ohm	Fault limit for temperature monitoring function 1.	1 = 1 unit
35.13	<i>Temperature 1 warning limit</i>	Defines the warning limit for temperature supervision function 1. When measured temperature 1 exceeds the limit, warning <a href="#">A491 External temperature 1</a> is generated. The unit is selected by parameter <a href="#">96.16 Unit selection</a> . <b>Notes:</b> <ul style="list-style-type: none"> <li>With a PTC sensor, the unit is ohms.</li> <li>With a PTC sensor, changing the value of this parameter has no effect on fault generation. When PTC is over the triggering threshold of the CMOD-02 (see the <i>Hardware manual of the drive</i>), the drive trips on the fault and when PTC has decreased below recovery threshold of the CMOD-02 (see the <i>Hardware manual of the drive</i>), the fault can be reset manually.</li> </ul>	110 °C or 230 °F or 4000 ohm
	-60...5000 °C or -76...9032 °F or 0...5000 ohm	Warning limit for temperature monitoring function 1.	1 = 1 unit
35.14	<i>Temperature 1 AI source</i>	Specifies the analog input when the setting of <a href="#">35.11 Temperature 1 source</a> requires measurement through an analog input.	<i>Not selected</i>
	Not selected	None.	0
	AI1 actual value	Analog input AI1 on the control unit.	1
	AI2 actual value	Analog input AI2 on the control unit.	2
	<i>Other</i>	Source selection (see <a href="#">Terms and abbreviations</a> on page 196).	-

## 340 Parameters

No.	Name/Value	Description	Def/FbEq16
35.21	<i>Temperature 2 source</i>	Selects the source from which measured temperature 2 is read. Usually this source is from a sensor connected to the motor controlled by the drive, but it could be used to measure and monitor a temperature from other parts of the process as long as a suitable sensor is used as per the selection list. See parameter <a href="#">35.11</a> .	<i>Estimated temperature</i>
	Disabled	None. Temperature monitoring function 2 is disabled.	0
	Estimated temperature	Estimated motor temperature (see parameter <a href="#">35.01 Motor estimated temperature</a> ). The temperature is estimated from an internal drive calculation. It is important to set up the ambient temperature of the motor in <a href="#">35.50 Motor ambient temperature</a> .	1
	KTY84 analog I/O	KTY84 sensor connected to the analog input selected by parameter <a href="#">35.24 Temperature 2 AI source</a> and an analog output. The following settings are required: <ul style="list-style-type: none"> <li>Set the hardware jumper or switch related to the analog input to <b>U</b> (voltage). Any change must be validated by a control unit reboot.</li> <li>Set the appropriate analog input unit selection parameter in group <a href="#">12 Standard AI</a> to <b>V</b> (volt).</li> <li>In parameter group <a href="#">13 Standard AO</a>, set the source selection parameter of the analog output to <a href="#">Temp sensor 2 excitation</a>.</li> </ul> The analog output feeds a constant current through the sensor. As the resistance of the sensor increases along with its temperature, the voltage over the sensor increases. The voltage is read by the analog input and converted into degrees.	2
	Reserved		3...4
	1 × Pt100 analog I/O	Pt100 sensor connected to a standard analog input selected by parameter <a href="#">35.24 Temperature 2 AI source</a> and an analog output. The following settings are required: <ul style="list-style-type: none"> <li>Set the hardware jumper or switch related to the analog input to <b>U</b> (voltage). Any change must be validated by a control unit reboot.</li> <li>Set the appropriate analog input unit selection parameter in group <a href="#">12 Standard AI</a> to <b>V</b> (volt).</li> <li>In parameter group <a href="#">13 Standard AO</a>, set the source selection parameter of the analog output to <a href="#">Temp sensor 2 excitation</a>.</li> </ul> The analog output feeds a constant current through the sensor. As the resistance of the sensor increases along with its temperature, the voltage over the sensor increases. The voltage is read by the analog input and converted into degrees.	5
	2 × Pt100 analog I/O	As selection <a href="#">1 × Pt100 analog I/O</a> , but with two sensors connected in series. Using multiple sensors improves measurement accuracy significantly.	6
	3 × Pt100 analog I/O	As selection <a href="#">1 × Pt100 analog I/O</a> , but with three sensors connected in series. Using multiple sensors improves measurement accuracy significantly.	7

No.	Name/Value	Description	Def/FbEq16
	PTC DI6	PTC sensor is connected to DI6. <b>Note:</b> With a PTC sensor connected DI6, the value shown is not a valid measurement. Either 0 ohm (normal temperature) or the value of parameter <a href="#">35.22 Temperature 2 fault limit</a> (excessive temperature) is shown.	8
	Reserved		9...10
	Direct temperature	The temperature is taken from the source selected by parameter <a href="#">35.24 Temperature 2 AI source</a> . The value of the source is assumed to be in the unit of temperature specified by parameter <a href="#">96.16 Unit selection</a> .	11
	KTY83 analog I/O	KTY83 sensor connected to the analog input selected by parameter <a href="#">35.14 Temperature 1 AI source</a> and an analog output. The following settings are required: <ul style="list-style-type: none"> <li>• Set the hardware jumper or switch related to the analog input to <b>U</b> (voltage). Any change must be validated by a control unit reboot.</li> <li>• Set the appropriate analog input unit selection parameter in group <a href="#">12 Standard AI</a> to <b>V</b> (volt).</li> <li>• In parameter group <a href="#">13 Standard AO</a>, set the source selection parameter of the analog output to <a href="#">Temp sensor 2 excitation</a>.</li> </ul> The analog output feeds a constant current through the sensor. As the resistance of the sensor increases along with its temperature, the voltage over the sensor increases. The voltage is read by the analog input and converted into degrees.	12
	1 × Pt1000 analog I/O	Pt1000 sensor connected to a standard analog input selected by parameter <a href="#">35.14 Temperature 1 AI source</a> and an analog output. The following settings are required: <ul style="list-style-type: none"> <li>• Set the hardware jumper or switch related to the analog input to <b>U</b> (voltage). Any change must be validated by a control unit reboot.</li> <li>• Set the appropriate analog input unit selection parameter in group <a href="#">12 Standard AI</a> to <b>V</b> (volt).</li> <li>• In parameter group <a href="#">13 Standard AO</a>, set the source selection parameter of the analog output to <a href="#">Temp sensor 2 excitation</a>.</li> </ul> The analog output feeds a constant current through the sensor. As the resistance of the sensor increases along with its temperature, the voltage over the sensor increases. The voltage is read by the analog input and converted into degrees.	13
	2 × Pt1000 analog I/O	As selection <a href="#">1 × Pt1000 analog I/O</a> , but with two sensors connected in series. Using multiple sensors improves measurement accuracy significantly.	14
	3 × Pt1000 analog I/O	As selection <a href="#">1 × Pt1000 analog I/O</a> , but with three sensors connected in series. Using multiple sensors improves measurement accuracy significantly.	15

## 342 Parameters

No.	Name/Value	Description	Def/FbEq16
	Ni1000	<p>Ni1000 sensor connected to the analog input selected by parameter <a href="#">35.14 Temperature 1 AI source</a> and an analog output.</p> <p>Sensors with thermal coefficient 6.18 ohm / 1 °C (6180 ppm/K) are supported. 100 °C corresponds to 1618 ohm.</p> <p>The following settings are required:</p> <ul style="list-style-type: none"> <li>Set the hardware jumper or switch related to the analog input to <b>U</b> (voltage). Any change must be validated by a control unit reboot.</li> <li>Set the appropriate analog input unit selection parameter in group <a href="#">12 Standard AI</a> to <b>V</b> (volt).</li> <li>In parameter group <a href="#">13 Standard AO</a>, set the source selection parameter of the analog output to <a href="#">Temp sensor 2 excitation</a>.</li> </ul> <p>The analog output feeds a constant current through the sensor. As the resistance of the sensor increases along with its temperature, the voltage over the sensor increases. The voltage is read by the analog input and converted into degrees.</p>	16
	Reserved		17...18
	PTC extension module	PTC is connected to the CMOD-02 multifunction extension module, which is installed in drive slot 2. See chapter <i>Optional I/O extension modules, section CMOD-02 multifunction extension module (external 24 V AC/DC and isolated PTC interface)</i> in the <i>Hardware manual</i> of the drive).	19
	PTC analog I/O	<p>PTC sensor connected to analog input selected by parameter <a href="#">35.24 Temperature 2 AI source</a> and an analog output.</p> <p>The required settings are the same as with selection <a href="#">KTY84 analog I/O</a>.</p> <p><b>Note:</b> With this selection, the control program converts the analog signal to PTC resistance value in ohms and shows it in parameter <a href="#">35.03</a>. The parameter name and unit still refer to temperature.</p>	20
	Therm(0)	PTC sensor or a normally closed thermistor connected relay to digital input DI6. The motor is overheated when the digital input is 0 m	21
	Therm(1)	Normally open thermistor relay connected to digital input DI6. The motor is overheated when the digital input is 1.	22
<a href="#">35.22</a>	<a href="#">Temperature 2 fault limit</a>	<p>Defines the fault limit for temperature supervision function 2. When measured temperature 1 exceeds the limit, the drive trips on fault <a href="#">4982 External temperature 2</a>.</p> <p>The unit is selected by parameter <a href="#">96.16 Unit selection</a>.</p> <p><b>Notes:</b></p> <ul style="list-style-type: none"> <li>With a PTC sensor, the unit is ohms.</li> <li>With a PTC sensor, changing the value of this parameter has no effect on fault generation. When PTC is over the triggering threshold of the CMOD-02 (see the <i>Hardware manual of the drive</i>), the drive trips on the fault and when PTC has decreased below recovery threshold of the CMOD-02 (see the <i>Hardware manual of the drive</i>), the fault can be reset manually.</li> </ul>	130 °C or 266 °F or 4500 ohm
	-60...5000 °C or -76...9032 °F or 0...5000 ohm	Fault limit for temperature monitoring function 2.	1 = 1 unit

No.	Name/Value	Description	Def/FbEq16
35.23	<i>Temperature 2 warning limit</i>	Defines the warning limit for temperature supervision function 2. When measured temperature 1 exceeds the limit, warning <a href="#">A492 External temperature 2</a> is generated. The unit is selected by parameter <a href="#">96.16 Unit selection</a> . <b>Notes:</b> <ul style="list-style-type: none"> <li>With a PTC sensor, the unit is ohms.</li> <li>With a PTC sensor, changing the value of this parameter has no effect on fault generation. When PTC is over the triggering threshold of the CMOD-02 (see the <i>Hardware manual of the drive</i>), the drive trips on the fault and when PTC has decreased below recovery threshold of the CMOD-02 (see the <i>Hardware manual of the drive</i>), the fault can be reset manually.</li> </ul>	110 °C or 230 °F or 4000 ohm
	-60...5000 °C or -76...9032 °F or 0...5000 ohm	Warning limit for temperature monitoring function 2.	1 = 1 unit
35.24	<i>Temperature 2 AI source</i>	Specifies the analog input when the setting of <a href="#">35.11 Temperature 1 source</a> requires measurement through an analog input.	<i>Not selected</i>
	Not selected	None.	0
	AI1 actual value	Analog input AI1 on the control unit.	1
	AI2 actual value	Analog input AI2 on the control unit.	2
	<i>Other</i>	Source selection (see <a href="#">Terms and abbreviations</a> on page 196).	-
35.31	<i>Safe motor temperature enable</i>	Activates or deactivates the Safe motor temperature (SMT) fault indication <a href="#">4991 Safe motor temperature</a> . Automatically activated when the CPTC-02 ATEX-certified thermistor protection module is connected to the drive.	<i>Off</i>
	Off	Activated.	0
	On	Deactivated.	1
35.50	<i>Motor ambient temperature</i>	Defines the ambient temperature of the motor for the motor thermal protection model. The unit is selected by parameter <a href="#">96.16 Unit selection</a> . The motor thermal protection model estimates the motor temperature on the basis of parameters <a href="#">35.50...35.55</a> . The motor temperature increases if it operates in the region above the load curve, and decreases if it operates in the region below the load curve.  <b>WARNING!</b> The model cannot protect the motor if the motor does not cool properly because of dust, dirt, etc.	20 °C or 68 °F
	-60...100 °C or -76 ... 212 °F	Ambient temperature.	1 = 1°

No.	Name/Value	Description	Def/FbEq16
35.51	<i>Motor load curve</i>	<p>Defines the motor load curve together with parameters <a href="#">35.52 Zero speed load</a> and <a href="#">35.53 Break point</a>. The load curve is used by the motor thermal protection model to estimate the motor temperature.</p> <p>When the parameter is set to 100%, the maximum load is taken as the value of parameter <a href="#">99.06 Motor nominal current</a> (higher loads heat up the motor). The load curve level should be adjusted if the ambient temperature differs from the nominal value set in <a href="#">35.50 Motor ambient temperature</a>.</p>	110%
<p style="text-align: center;"> <math>I</math> = Motor current  <math>I_N</math> = Nominal motor current         </p>			
	50...150%	Maximum load for the motor load curve.	1 = 1%
35.52	<i>Zero speed load</i>	<p>Defines the motor load curve together with parameters <a href="#">35.51 Motor load curve</a> and <a href="#">35.53 Break point</a>. Defines the maximum motor load at zero speed of the load curve. A higher value can be used if the motor has an external motor fan to boost the cooling. See the motor manufacturer's recommendations.</p> <p>See parameter <a href="#">35.51 Motor load curve</a>.</p>	70%
	25...150%	Zero speed load for the motor load curve.	1 = 1%
35.53	<i>Break point</i>	<p>Defines the motor load curve together with parameters <a href="#">35.51 Motor load curve</a> and <a href="#">35.52 Zero speed load</a>. Defines the break point frequency of the load curve ie. the point at which the motor load curve begins to decrease from the value of parameter <a href="#">35.51 Motor load curve</a> towards the value of parameter <a href="#">35.52 Zero speed load</a>.</p> <p>See parameter <a href="#">35.51 Motor load curve</a>.</p>	45.00 Hz
	1.00...500.00 Hz	Break point for the motor load curve.	See par. <a href="#">46.02</a>

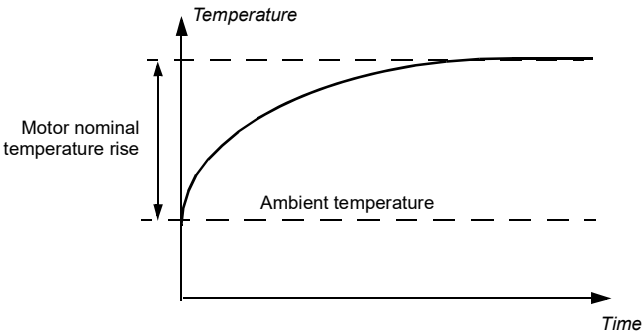
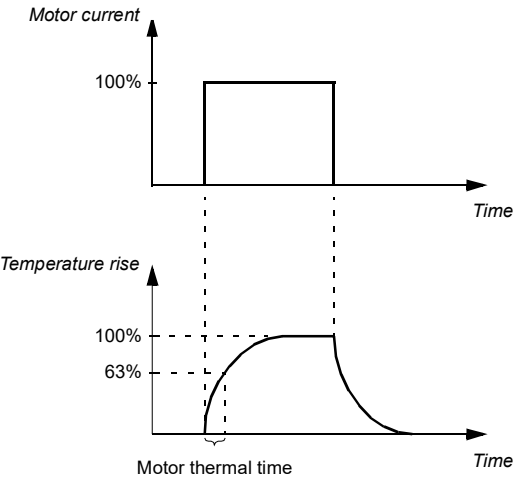

No.	Name/Value	Description	Def/FbEq16
35.54	<i>Motor nominal temperature rise</i>	<p>Defines the temperature rise of the motor above ambient when the motor is loaded with nominal current. See the motor manufacturer's recommendations.</p> <p>The unit is selected by parameter <a href="#">96.16 Unit selection</a>.</p> 	80 °C or 176 °F
	0...300 °C or 32...572 °F	Temperature rise.	1 = 1°
35.55	<i>Motor thermal time constant</i>	<p>Defines the thermal time constant for use with the motor thermal protection model, defined as the time to reach 63% of the nominal motor temperature. See the motor manufacturer's recommendations.</p> <p>For thermal protection according to UL requirements for NEMA class motors, use the rule of thumb: Motor thermal time equals 35 times <math>t_6</math>, where <math>t_6</math> (in seconds) is specified by the motor manufacturer as the time that the motor can safely operate at six times its rated current.</p> 	256 s
	100...10000 s	Motor thermal time constant.	1 = 1 s

## 346 Parameters

No.	Name/Value	Description	Def/FbEq16
<b>35.56</b>	<b>Motor overload action</b>	Selects the action taken when motor overload is detected. See section <a href="#">Motor overload protection</a> (page 182).	<a href="#">Warning and fault</a>
	No action	No action taken.	0
	Warning only	Drive generates warning <a href="#">A783 Motor overload</a> when the motor is overloaded to the warning level, that is, parameter <a href="#">35.05 Motor overload level</a> reaches value 88.0%.	1
	Warning and fault	Drive generates warning <a href="#">A783 Motor overload</a> when the motor is overloaded to the warning level, that is, parameter <a href="#">35.05 Motor overload level</a> reaches value 88.0%. Drive trips on fault <a href="#">7122 Motor overload</a> when the motor is overloaded to the fault level, that is, parameter <a href="#">35.05 Motor overload level</a> reaches value 100.0%.	2
<b>35.57</b>	<b>Motor overload class</b>	Defines the motor overload class to be used. The class of protection is specified by the user as the time for tripping at 7.2 times (IEC 60947-4-1) or 6 times (NEMA ICS) the tripping level current. See section <a href="#">Motor overload protection</a> (page 182).	<a href="#">Class 20</a>
	Class 5	Motor overload class 5.	0
	Class 10	Motor overload class 10.	1
	Class 20	Motor overload class 20.	2
	Class 30	Motor overload class 30.	3
	Class 40	Motor overload class 40.	4
<b>36 Load analyzer</b>		Peak value and amplitude logger settings. See also section <a href="#">Load analyzer</a> (page 187).	
<b>36.01</b>	<b>PVL signal source</b>	Selects the signal to be monitored by the peak value logger. The signal is filtered using the filtering time specified by parameter <a href="#">36.02 PVL filter time</a> . The peak value is stored, along with other pre-selected signals at the time, into parameters <a href="#">36.10...36.15</a> . The peak value logger can be reset using parameter <a href="#">36.09 Reset loggers</a> . The logger is also reset whenever the signal source is changed. The date and time of the last reset are stored into parameters <a href="#">36.16</a> and <a href="#">36.17</a> respectively.	<a href="#">Output power</a>
	Not selected	None (peak value logger disabled).	0
	Motor speed used	<a href="#">01.01 Motor speed used</a> (page 199).	1
	Reserved		2
	Output frequency	<a href="#">01.06 Output frequency</a> (page 199).	3
	Motor current	<a href="#">01.07 Motor current</a> (page 199).	4
	Reserved		5
	Motor torque	<a href="#">01.10 Motor torque</a> (page 199).	6
	DC voltage	<a href="#">01.11 DC voltage</a> (page 199).	7
	Output power	<a href="#">01.14 Output power</a> (page 200).	8
	Reserved		9
	Speed ref ramp in	<a href="#">23.01 Speed ref ramp input</a> (page 276).	10
	Speed ref ramp out	<a href="#">23.02 Speed ref ramp output</a> (page 276).	11
	Speed ref used	<a href="#">24.01 Used speed reference</a> (page 280).	12
	Torque ref used	<a href="#">26.02 Torque reference used</a> (page 286).	13

No.	Name/Value	Description	Def/FbEq16
	Freq ref used	<a href="#">28.02 Frequency ref ramp output</a> (page 291).	14
	Reserved		15
	Process PID out	<a href="#">40.01 Process PID output actual</a> (page 353).	16
	<i>Other</i>	Source selection (see <a href="#">Terms and abbreviations</a> on page 196).	-
<b>36.02</b>	<b><i>PVL filter time</i></b>	Peak value logger filtering time. See parameter <a href="#">36.01 PVL signal source</a> .	2.00 s
	0.00...120.00 s	Peak value logger filtering time.	100 = 1 s
<b>36.06</b>	<b><i>AL2 signal source</i></b>	Selects the signal to be monitored by amplitude logger 2. The signal is sampled at 200 ms intervals. The results are displayed by parameters <a href="#">36.40...36.49</a> . Each parameter represents an amplitude range, and shows what portion of the samples fall within that range. The signal value corresponding to 100% is defined by parameter <a href="#">36.07 AL2 signal scaling</a> . Amplitude logger 2 can be reset using parameter <a href="#">36.09 Reset loggers</a> . The logger is also reset whenever the signal source or scaling is changed. The date and time of the last reset are stored into parameters <a href="#">36.50</a> and <a href="#">36.51</a> respectively. For the selections, see parameter <a href="#">36.01 PVL signal source</a> .	<i>Motor torque</i>
<b>36.07</b>	<b><i>AL2 signal scaling</i></b>	Defines the signal value that corresponds to 100% amplitude.	100.00
	0.00...32767.00	Signal value corresponding to 100%.	1 = 1
<b>36.09</b>	<b><i>Reset loggers</i></b>	Resets the peak value logger and/or amplitude logger 2. (Amplitude logger 1 cannot be reset.)	<i>Done</i>
	Done	Reset completed or not requested (normal operation).	0
	All	Reset both the peak value logger and amplitude logger 2.	1
	PVL	Reset the peak value logger.	2
	AL2	Reset amplitude logger 2.	3
<b>36.10</b>	<b><i>PVL peak value</i></b>	Peak value recorded by the peak value logger.	0.00
	-32768.00... 32767.00	Peak value.	1 = 1
<b>36.11</b>	<b><i>PVL peak date</i></b>	The date on which the peak value was recorded.	01.01.1980
	-	Peak occurrence date.	-
<b>36.12</b>	<b><i>PVL peak time</i></b>	The time at which the peak value was recorded.	00:00:00
	-	Peak occurrence time.	-
<b>36.13</b>	<b><i>PVL current at peak</i></b>	Motor current at the moment the peak value was recorded.	0.00 A
	-32768.00... 32767.00 A	Motor current at peak.	1 = 1 A
<b>36.14</b>	<b><i>PVL DC voltage at peak</i></b>	Voltage in the intermediate DC circuit of the drive at the moment the peak value was recorded.	0.00 V
	0.00...2000.00 V	DC voltage at peak.	10 = 1 V
<b>36.15</b>	<b><i>PVL speed at peak</i></b>	Motor speed at the moment the peak value was recorded.	0.00 rpm
	-30000.00... 30000.00 rpm	Motor speed at peak.	See par. <a href="#">46.01</a>
<b>36.16</b>	<b><i>PVL reset date</i></b>	The date on which the peak value logger was last reset.	01.01.1980
	-	Last reset date of the peak value logger.	-

## 348 Parameters

No.	Name/Value	Description	Def/FbEq16
36.17	<i>PVL reset time</i>	The time at which the peak value logger was last reset.	00:00:00
	-	Last reset time of the peak value logger.	-
36.20	<i>AL1 0 to 10%</i>	Percentage of samples recorded by amplitude logger 1 that fall between 0 and 10%. 100% corresponds to the $I_{\max}$ value given in the ratings table in chapter Technical data in the <i>Hardware manual</i> of the drive.	0.00%
	0.00...100.00%	Amplitude logger 1 samples between 0 and 10%.	1 = 1%
36.21	<i>AL1 10 to 20%</i>	Percentage of samples recorded by amplitude logger 1 that fall between 10 and 20%.	0.00%
	0.00...100.00%	Amplitude logger 1 samples between 10 and 20%.	1 = 1%
36.22	<i>AL1 20 to 30%</i>	Percentage of samples recorded by amplitude logger 1 that fall between 20 and 30%.	0.00%
	0.00...100.00%	Amplitude logger 1 samples between 20 and 30%.	1 = 1%
36.23	<i>AL1 30 to 40%</i>	Percentage of samples recorded by amplitude logger 1 that fall between 30 and 40%.	0.00%
	0.00...100.00%	Amplitude logger 1 samples between 30 and 40%.	1 = 1%
36.24	<i>AL1 40 to 50%</i>	Percentage of samples recorded by amplitude logger 1 that fall between 40 and 50%.	0.00%
	0.00...100.00%	Amplitude logger 1 samples between 40 and 50%.	1 = 1%
36.25	<i>AL1 50 to 60%</i>	Percentage of samples recorded by amplitude logger 1 that fall between 50 and 60%.	0.00%
	0.00...100.00%	Amplitude logger 1 samples between 50 and 60%.	1 = 1%
36.26	<i>AL1 60 to 70%</i>	Percentage of samples recorded by amplitude logger 1 that fall between 60 and 70%.	0.00%
	0.00...100.00%	Amplitude logger 1 samples between 60 and 70%.	1 = 1%
36.27	<i>AL1 70 to 80%</i>	Percentage of samples recorded by amplitude logger 1 that fall between 70 and 80%.	0.00%
	0.00...100.00%	Amplitude logger 1 samples between 70 and 80%.	1 = 1%
36.28	<i>AL1 80 to 90%</i>	Percentage of samples recorded by amplitude logger 1 that fall between 80 and 90%.	0.00%
	0.00...100.00%	Amplitude logger 1 samples between 80 and 90%.	1 = 1%
36.29	<i>AL1 over 90%</i>	Percentage of samples recorded by amplitude logger 1 that exceed 90%.	0.00%
	0.00...100.00%	Amplitude logger 1 samples over 90%.	1 = 1%
36.40	<i>AL2 0 to 10%</i>	Percentage of samples recorded by amplitude logger 2 that fall between 0 and 10%.	0.00%
	0.00...100.00%	Amplitude logger 2 samples between 0 and 10%.	1 = 1%
36.41	<i>AL2 10 to 20%</i>	Percentage of samples recorded by amplitude logger 2 that fall between 10 and 20%.	0.00%
	0.00...100.00%	Amplitude logger 2 samples between 10 and 20%.	1 = 1%
36.42	<i>AL2 20 to 30%</i>	Percentage of samples recorded by amplitude logger 2 that fall between 20 and 30%.	0.00%
	0.00...100.00%	Amplitude logger 2 samples between 20 and 30%.	1 = 1%
36.43	<i>AL2 30 to 40%</i>	Percentage of samples recorded by amplitude logger 2 that fall between 30 and 40%.	0.00%
	0.00...100.00%	Amplitude logger 2 samples between 30 and 40%.	1 = 1%

No.	Name/Value	Description	Def/FbEq16
36.44	<a href="#">AL2 40 to 50%</a>	Percentage of samples recorded by amplitude logger 2 that fall between 40 and 50%.	0.00%
	0.00...100.00%	Amplitude logger 2 samples between 40 and 50%.	1 = 1%
36.45	<a href="#">AL2 50 to 60%</a>	Percentage of samples recorded by amplitude logger 2 that fall between 50 and 60%.	0.00%
	0.00...100.00%	Amplitude logger 2 samples between 50 and 60%.	1 = 1%
36.46	<a href="#">AL2 60 to 70%</a>	Percentage of samples recorded by amplitude logger 2 that fall between 60 and 70%.	0.00%
	0.00...100.00%	Amplitude logger 2 samples between 60 and 70%.	1 = 1%
36.47	<a href="#">AL2 70 to 80%</a>	Percentage of samples recorded by amplitude logger 2 that fall between 70 and 80%.	0.00%
	0.00...100.00%	Amplitude logger 2 samples between 70 and 80%.	1 = 1%
36.48	<a href="#">AL2 80 to 90%</a>	Percentage of samples recorded by amplitude logger 2 that fall between 80 and 90%.	0.00%
	0.00...100.00%	Amplitude logger 2 samples between 80 and 90%.	1 = 1%
36.49	<a href="#">AL2 over 90%</a>	Percentage of samples recorded by amplitude logger 2 that exceed 90%.	0.00%
	0.00...100.00%	Amplitude logger 2 samples over 90%.	1 = 1%
36.50	<a href="#">AL2 reset date</a>	The date on which amplitude logger 2 was last reset.	01.01.1980
	-	Last reset date of amplitude logger 2.	-
36.51	<a href="#">AL2 reset time</a>	The time at which amplitude logger 2 was last reset.	00:00:00
	-	Last reset time of amplitude logger 2.	-

<b>37 User load curve</b>		Settings for user load curve. See also section <a href="#">User load curve</a> (page 129).	
37.01	<a href="#">ULC output status word</a>	Displays the status of the monitored signal. The status is shown only while the drive is running. (The status word is independent of the actions and delays selected by parameters <a href="#">37.03</a> , <a href="#">37.04</a> , <a href="#">37.41</a> and <a href="#">37.42</a> .) This parameter is read-only.	0000h
<b>Bit</b>	<b>Name</b>	<b>Description</b>	
0	Under load limit	1 = Signal lower than the underload curve.	
1	Within load range	1 = Signal between the underload and overload curve.	
2	Overload limit	1 = Signal higher than the overload curve.	
3	Outside load limit	1 = Signal lower than the underload curve or higher than the overload curve.	
4...15	Reserved		
	0000h...FFFFh	Status of the monitored signal.	1 = 1
37.02	<a href="#">ULC supervision signal</a>	Selects the signal to be monitored. The function compares the absolute value of the signal against the load curve.	<a href="#">Motor torque %</a>
	Not selected	No signal selected (monitoring disabled).	0
	Motor speed %	<a href="#">01.03 Motor speed %</a> (page 199).	1
	Motor current %	<a href="#">01.08 Motor current % of motor nom</a> (page 199).	2
	Motor torque %	<a href="#">01.10 Motor torque</a> (page 199).	3

## 350 Parameters

No.	Name/Value	Description	Def/FbEq16
	Output power % of motor nominal	<a href="#">01.15 Output power % of motor nom</a> (page 200).	4
	Output power % of drive nominal	Output power % of drive nominal.	5
	<i>Other</i>	Source selection (see <a href="#">Terms and abbreviations</a> on page 196).	-
<b>37.03</b>	<b><i>ULC overload actions</i></b>	Selects how the drive reacts if the absolute value of the monitored signal stays continuously above the overload curve for longer than the value of <a href="#">37.41 ULC overload timer</a> .	<i>Disabled</i>
	Disabled	No action taken.	0
	Warning	The drive generates a warning ( <a href="#">A8BE ULC overload warning</a> ).	1
	Fault	The drive trips on <a href="#">8002 ULC overload fault</a> .	2
	Warning/Fault	The drive generates a warning ( <a href="#">A8BE ULC overload warning</a> ) if the signal stays continuously above the overload curve for half of the time defined by parameter <a href="#">37.41 ULC overload timer</a> . The drive trips on <a href="#">8002 ULC overload fault</a> if the signal stays continuously above the overload curve for a time defined by parameter <a href="#">37.41 ULC overload timer</a> .	3
<b>37.04</b>	<b><i>ULC underload actions</i></b>	Selects how the drive reacts if the absolute value of the monitored signal stays continuously below the overload curve for longer than the value of <a href="#">37.42 ULC underload timer</a> .	<i>Disabled</i>
	Disabled	No action taken.	0
	Warning	The drive generates a warning ( <a href="#">A8BF ULC underload warning</a> ).	1
	Fault	The drive trips on <a href="#">8001 ULC underload fault</a> .	2
	Warning/Fault	The drive generates a warning ( <a href="#">A8BF ULC underload warning</a> ) if the signal stays continuously below the underload curve for half of the time defined by parameter <a href="#">37.41 ULC overload timer</a> . The drive trips on <a href="#">8001 ULC underload fault</a> if the signal stays continuously below the underload curve for a time defined by parameter <a href="#">37.42 ULC underload timer</a> .	3
<b>37.11</b>	<b><i>ULC speed table point 1</i></b>	Defines the first of the five speed points on the X-axis of the user load curve. Speed points are used if parameter <a href="#">99.04 Motor control mode</a> is set to <i>Vector</i> or if <a href="#">99.04 Motor control mode</a> is set to <i>Scalar</i> and the reference unit is rpm. The five points must be in order from lowest to highest. The points are defined as positive values, but the range is symmetrically effective also in the negative direction. The monitoring is not active outside these two areas.	150.0 rpm
	-30000.0...30000.0 rpm	Speed.	1 = 1 rpm
<b>37.12</b>	<b><i>ULC speed table point 2</i></b>	Defines the second speed point. See parameter <a href="#">37.11 ULC speed table point 1</a> .	750.0 rpm
	-30000.0...30000.0 rpm	Speed.	1 = 1 rpm

No.	Name/Value	Description	Def/FbEq16
37.13	<a href="#">ULC speed table point 3</a>	Defines the third speed point. See parameter <a href="#">37.11 ULC speed table point 1</a> .	1290.0 rpm
	-30000.0...30000.0 rpm	Speed.	1 = 1 rpm
37.14	<a href="#">ULC speed table point 4</a>	Defines the fourth speed point. See parameter <a href="#">37.11 ULC speed table point 1</a> .	1500.0 rpm
	-30000.0...30000.0 rpm	Speed.	1 = 1 rpm
37.15	<a href="#">ULC speed table point 5</a>	Defines the fifth speed point. See parameter <a href="#">37.11 ULC speed table point 1</a> .	1800.0 rpm
	-30000.0...30000.0 rpm	Speed.	1 = 1 rpm
37.16	<a href="#">ULC frequency table point 1</a>	Defines the first of the five frequency points on the X-axis of the user load curve. Frequency points are used if parameter <a href="#">99.04 Motor control mode</a> is set to <i>Scalar</i> and the reference unit is Hz. The five points must be in order from lowest to highest. The points are defined as positive values, but the range is symmetrically effective also in the negative direction. The monitoring is not active outside these two areas.	5.0 Hz
	-500.0...500.0 Hz	Frequency.	1 = 1 Hz
37.17	<a href="#">ULC frequency table point 2</a>	Defines the second frequency point. See parameter <a href="#">37.16 ULC frequency table point 1</a> .	25.0 Hz
	-500.0...500.0 Hz	Frequency.	1 = 1 Hz
37.18	<a href="#">ULC frequency table point 3</a>	Defines the third frequency point. See parameter <a href="#">37.16 ULC frequency table point 1</a> .	43.0 Hz
	-500.0...500.0 Hz	Frequency.	1 = 1 Hz
37.19	<a href="#">ULC frequency table point 4</a>	Defines the fourth frequency point. See parameter <a href="#">37.16 ULC frequency table point 1</a> .	50.0 Hz
	-500.0...500.0 Hz	Frequency.	1 = 1 Hz
37.20	<a href="#">ULC frequency table point 5</a>	Defines the fifth frequency point. See parameter <a href="#">37.16 ULC frequency table point 1</a> .	60.0 Hz
	-500.0...500.0 Hz	Frequency.	1 = 1 Hz
37.21	<a href="#">ULC underload point 1</a>	Defines the first of the five points on the Y-axis that together with the corresponding point on the X-axis ( <a href="#">37.11 ULC speed table point 1</a> ... <a href="#">37.15 ULC speed table point 5</a> or <a href="#">37.15 ULC speed table point 5</a> ... <a href="#">37.20 ULC frequency table point 5</a> ) define the underload (lower) curve. Each point of the underload curve must have a lower value than the corresponding overload point.	10.0%
	-1600.0...1600.0%	Underload point.	1 = 1%
37.22	<a href="#">ULC underload point 2</a>	Defines the second underload point. See parameter <a href="#">37.21 ULC underload point 1</a> .	15.0%
	-1600.0...1600.0%	Underload point.	1 = 1%
37.23	<a href="#">ULC underload point 3</a>	Defines the third underload point. See parameter <a href="#">37.21 ULC underload point 1</a>	25.0%
	-1600.0...1600.0%	Underload point.	1 = 1%

## 352 Parameters

No.	Name/Value	Description	Def/FbEq16
37.24	<i>ULC underload point 4</i>	Defines the fourth underload point. See parameter <i>37.21 ULC underload point 1</i>	30.0%
	-1600.0...1600.0%	Underload point.	1 = 1%
37.25	<i>ULC underload point 5</i>	Defines the fifth underload point. See parameter <i>37.21 ULC underload point 1</i>	30.0%
	-1600.0...1600.0%	Underload point.	1 = 1%
37.31	<i>ULC overload point 1</i>	Defines the first of the five points on the Y-axis that together with the corresponding point on the X-axis ( <i>37.11 ULC speed table point 1...37.15 ULC speed table point 5</i> or <i>37.15 ULC speed table point 5...37.20 ULC frequency table point 5</i> ) define the overload (higher) curve. Each point of the overload curve must have a higher value than the corresponding underload point.	300.0%
	-1600.0...1600.0%	Overload point.	1 = 1%
37.32	<i>ULC overload point 2</i>	Defines the second overload point. See parameter <i>37.31 ULC overload point 1.</i>	300.0%
	-1600.0...1600.0%	Overload point.	1 = 1%
37.33	<i>ULC overload point 3</i>	Defines the third overload point. See parameter <i>37.31 ULC overload point 1.</i>	300.0%
	-1600.0...1600.0%	Overload point.	1 = 1%
37.34	<i>ULC overload point 4</i>	Defines the fourth overload point. See parameter <i>37.31 ULC overload point 1.</i>	300.0%
	-1600.0...1600.0%	Overload point.	1 = 1%
37.35	<i>ULC overload point 5</i>	Defines the fifth overload point. See parameter <i>37.31 ULC overload point 1.</i>	300.0%
	-1600.0...1600.0%	Overload point.	1 = 1%
37.41	<i>ULC overload timer</i>	Defines the time for which the monitored signal must continuously stay above the overload curve before the drive takes the action selected by <i>37.03 ULC overload actions.</i>	20.0 s
	0.0...10000.0 s	Overload timer.	1 = 1 s
37.42	<i>ULC underload timer</i>	Defines the time for which the monitored signal must continuously stay below the underload curve before the drive takes the action selected by <i>37.04 ULC underload actions.</i>	20.0 s
	0.0...10000.0 s	Underload timer.	1 = 1 s



No.	Name/Value	Description	Def/FbEq16
<b>40 Process PID set 1</b>		<p>Parameter values for process PID control.</p> <p>The drive output can be controlled by the process PID. When the process PID control is enabled, the drive controls the process feedback to the reference value.</p> <p>Two different parameter sets can be defined for the process PID. One parameter set is in use at a time. The first set is made up of parameters <a href="#">40.07...40.90</a> the second set is defined by the parameters in group <a href="#">41 Process PID set 2</a>. The binary source that defines which set is used is selected by parameter <a href="#">40.57 PID set1/set2 selection</a>.</p> <p>See also the control chain diagrams on pages <a href="#">563</a> and <a href="#">564</a>. To set the PID customer unit, select <b>Menu - Primary settings - PID - Unit</b> on the control panel.</p>	
	<b>40.01 Process PID output actual</b>	<p>Displays the output of the process PID controller. See the control chain diagram on page <a href="#">564</a>.</p> <p>This parameter is read-only.</p>	-
	-200000.00... 200000.00	Process PID controller output.	1 = 1
<b>40.02 Process PID feedback actual</b>		<p>Displays the value of process feedback after source selection, mathematical function (parameter <a href="#">40.10 Set 1 feedback function</a>), and filtering. See the control chain diagram on page <a href="#">563</a>.</p> <p>This parameter is read-only.</p>	-
	-200000.00... 200000.00 PID customer units	Process feedback.	1 = 1 PID customer unit
<b>40.03 Process PID setpoint actual</b>		<p>Displays the value of process PID setpoint after source selection, mathematical function (<a href="#">40.18 Set 1 setpoint function</a>), limitation and ramping. See the control chain diagram on page <a href="#">563</a>.</p> <p>This parameter is read-only.</p>	-
	-200000.00... 200000.00 PID customer units	Setpoint for process PID controller.	1 = 1 PID customer unit
<b>40.04 Process PID deviation actual</b>		<p>Displays the process PID deviation. By default, this value equals setpoint - feedback, but deviation can be inverted by parameter <a href="#">40.31 Set 1 deviation inversion</a>. See the control chain diagram on page <a href="#">564</a>.</p> <p>This parameter is read-only.</p>	-
	-200000.00... 200000.00 PID customer units	PID deviation.	1 = 1 PID customer unit
<b>40.05 Process PID trim output act</b>		<p>Displays the process PID trimmed reference output. See control chain diagram on page <a href="#">564</a>.</p> <p>This parameter is read-only.</p>	-
	-32768.0...32767.0	Process PID trimmed reference.	1 = 1

No.	Name/Value	Description	Def/FbEq16																																													
40.06	<i>Process PID status word</i>	Displays status information on process PID control. This parameter is read-only.	-																																													
<table border="1"> <thead> <tr> <th>Bit</th> <th>Name</th> <th>Value</th> </tr> </thead> <tbody> <tr> <td>0</td> <td>PID active</td> <td>1 = Process PID control active.</td> </tr> <tr> <td>1</td> <td>Setpoint frozen</td> <td>1 = Process PID setpoint frozen.</td> </tr> <tr> <td>2</td> <td>Output frozen</td> <td>1 = Process PID controller output frozen.</td> </tr> <tr> <td>3</td> <td>PID sleep mode</td> <td>1 = Sleep mode active.</td> </tr> <tr> <td>4</td> <td>Sleep boost</td> <td>1 = Sleep boost active.</td> </tr> <tr> <td>5</td> <td>Trim mode</td> <td>1 = Trim mode active</td> </tr> <tr> <td>6</td> <td>Tracking mode</td> <td>1 = Tracking function active.</td> </tr> <tr> <td>7</td> <td>Output limit high</td> <td>1 = PID output is being limited by par. 40.37.</td> </tr> <tr> <td>8</td> <td>Output limit low</td> <td>1 = PID output is being limited by par. 40.36.</td> </tr> <tr> <td>9</td> <td>Deadband active</td> <td>1 = Deadband active (see par. 40.39)</td> </tr> <tr> <td>10</td> <td>PID set</td> <td>0 = Parameter set 1 in use. 1 = Parameter set 2 in use.</td> </tr> <tr> <td>11</td> <td>Reserved</td> <td></td> </tr> <tr> <td>12</td> <td>Internal setpoint active</td> <td>1 = Internal setpoint active (see par. 40.16...40.23)</td> </tr> <tr> <td>13...15</td> <td>Reserved</td> <td></td> </tr> </tbody> </table>				Bit	Name	Value	0	PID active	1 = Process PID control active.	1	Setpoint frozen	1 = Process PID setpoint frozen.	2	Output frozen	1 = Process PID controller output frozen.	3	PID sleep mode	1 = Sleep mode active.	4	Sleep boost	1 = Sleep boost active.	5	Trim mode	1 = Trim mode active	6	Tracking mode	1 = Tracking function active.	7	Output limit high	1 = PID output is being limited by par. 40.37.	8	Output limit low	1 = PID output is being limited by par. 40.36.	9	Deadband active	1 = Deadband active (see par. 40.39)	10	PID set	0 = Parameter set 1 in use. 1 = Parameter set 2 in use.	11	Reserved		12	Internal setpoint active	1 = Internal setpoint active (see par. 40.16...40.23)	13...15	Reserved	
Bit	Name	Value																																														
0	PID active	1 = Process PID control active.																																														
1	Setpoint frozen	1 = Process PID setpoint frozen.																																														
2	Output frozen	1 = Process PID controller output frozen.																																														
3	PID sleep mode	1 = Sleep mode active.																																														
4	Sleep boost	1 = Sleep boost active.																																														
5	Trim mode	1 = Trim mode active																																														
6	Tracking mode	1 = Tracking function active.																																														
7	Output limit high	1 = PID output is being limited by par. 40.37.																																														
8	Output limit low	1 = PID output is being limited by par. 40.36.																																														
9	Deadband active	1 = Deadband active (see par. 40.39)																																														
10	PID set	0 = Parameter set 1 in use. 1 = Parameter set 2 in use.																																														
11	Reserved																																															
12	Internal setpoint active	1 = Internal setpoint active (see par. 40.16...40.23)																																														
13...15	Reserved																																															
	0000h...FFFFh	Process PID control status word.	1 = 1																																													
40.07	<i>Process PID operation mode</i>	Activates/deactivates process PID control. <b>Note:</b> Process PID control is only available in external control; see section <i>Local control vs. external control</i> (page 107).	<i>Off</i>																																													
	Off	Process PID control inactive.	0																																													
	On	Process PID control active.	1																																													
	On when drive running	Process PID control is active when the drive is running.	2																																													
40.08	<i>Set 1 feedback 1 source</i>	Selects the primary source of process feedback. See the control chain diagram on page 563.	<i>A/2 percent</i>																																													
	Not selected	None.	0																																													
	A/1 scaled	12.12 <i>A/1 scaled value</i> (see page 227).	1																																													
	A/2 scaled	12.22 <i>A/2 scaled value</i> (see page 229).	2																																													
	Freq in scaled	11.39 <i>Freq in 1 scaled value</i> (see page 225).	3																																													
	Reserved		4...7																																													
	A/1 percent	12.101 <i>A/1 percent value</i> (see page 230).	8																																													
	A/2 percent	12.102 <i>A/2 percent value</i> (see page 230).	9																																													
	Feedback data storage	40.91 <i>Feedback data storage</i> (see page 368).	10																																													
	<i>Other</i>	Source selection (see <i>Terms and abbreviations</i> on page 196).	-																																													
40.09	<i>Set 1 feedback 2 source</i>	Selects the second source of process feedback. The second source is used only if the setpoint function requires two inputs. For the selections, see parameter 40.08 <i>Set 1 feedback 1 source</i> .	<i>Not selected</i>																																													

No.	Name/Value	Description	Def/FbEq16								
40.10	<i>Set 1 feedback function</i>	Defines how process feedback is calculated from the two feedback sources selected by parameters <i>40.08 Set 1 feedback 1 source</i> and <i>40.09 Set 1 feedback 2 source</i> . The result of the function (for any selection) is multiplied by parameter <i>40.90 Set 1 feedback multiplier</i> .	<i>ln1</i>								
	ln1	Source 1.	0								
	ln1+ln2	Sum of sources 1 and 2.	1								
	ln1-ln2	Source 2 subtracted from source 1.	2								
	ln1*ln2	Source 1 multiplied by source 2.	3								
	ln1/ln2	Source 1 divided by source 2.	4								
	MIN(ln1,ln2)	Smaller of the two sources.	5								
	MAX(ln1,ln2)	Greater of the two sources.	6								
	AVE(ln1,ln2)	Average of the two sources.	7								
	sqrt(ln1)	Square root of source 1.	8								
	sqrt(ln1-ln2)	Square root of (source 1 - source 2).	9								
	sqrt(ln1+ln2)	Square root of (source 1 + source 2).	10								
	sqrt(ln1)+sqrt(ln2)	Square root of source 1 + square root of source 2.	11								
40.11	<i>Set 1 feedback filter time</i>	Defines the filter time constant for process feedback.	0.000 s								
	0.000...30.000 s	Feedback filter time.	1 = 1 s								
40.14	<i>Set 1 setpoint scaling</i>	Defines, together with parameter <i>40.15 Set 1 output scaling</i> , a general scaling factor for the process PID control chain. If the parameter is set to zero, automatic setpoint scaling is activated, where suitable setpoint scale is calculated according to selected setpoint source. Actual setpoint scale is shown in parameter <i>40.61 Setpoint scaling actual</i> . The scaling can be utilized when, for example, the process setpoint is input in Hz, and the output of the PID controller is used as an rpm value in speed control. In this case, this parameter might be set to 50, and parameter <i>40.15</i> to the nominal motor speed at 50 Hz. In effect, the output of the PID controller = [ <i>40.15</i> ] when deviation (setpoint - feedback) = [ <i>40.14</i> ] and [ <i>40.32</i> ] = 1. <b>Note:</b> The scaling is based on the ratio between <i>40.14</i> and <i>40.15</i> . For example, the values 50 and 1500 would produce the same scaling as 1 and 30.	0.00								
	-200000.00... 200000.00	Scaling.	1 = 1								
40.15	<i>Set 1 output scaling</i>	See parameter <i>40.14 Set 1 setpoint scaling</i> . If the parameter is set to zero, scaling is automatic, and according to column Scaling:	0.00								
		<table border="1"> <thead> <tr> <th>Operation mode (see par. 19.01)</th> <th>Scaling</th> </tr> </thead> <tbody> <tr> <td>Speed control</td> <td><i>46.01 Speed scaling</i></td> </tr> <tr> <td>Frequency control</td> <td><i>46.02 Frequency scaling</i></td> </tr> <tr> <td>Torque control</td> <td>100%</td> </tr> </tbody> </table>	Operation mode (see par. 19.01)	Scaling	Speed control	<i>46.01 Speed scaling</i>	Frequency control	<i>46.02 Frequency scaling</i>	Torque control	100%	
Operation mode (see par. 19.01)	Scaling										
Speed control	<i>46.01 Speed scaling</i>										
Frequency control	<i>46.02 Frequency scaling</i>										
Torque control	100%										
	-200000.00... 200000.00	Process PID controller output base.	1 = 1								

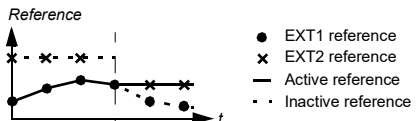
No.	Name/Value	Description	Def/FbEq16
40.16	<a href="#">Set 1 setpoint 1 source</a>	Selects the primary source of process PID setpoint. See the control chain diagram on page 563.	<a href="#">A11 percent</a>
	Not selected	None.	0
	Reserved		1
	Internal setpoint	Internal setpoint. See parameter <a href="#">40.19 Set 1 internal setpoint self</a> .	2
	AI1 scaled	<a href="#">12.12 AI1 scaled value</a> (see page 227).	3
	AI2 scaled	<a href="#">12.22 AI2 scaled value</a> (see page 229).	4
	Reserved		5...7
	Motor potentiometer	<a href="#">22.80 Motor potentiometer ref act</a> (output of the motor potentiometer).	8
	Reserved		9
	Freq in scaled	<a href="#">11.39 Freq in 1 scaled value</a> (see page 225).	10
	AI1 percent	<a href="#">12.101 AI1 percent value</a> (see page 230)	11
	AI2 percent	<a href="#">12.102 AI2 percent value</a> (see page 230)	12
	Control panel (ref saved)	Control panel reference ( <a href="#">03.01 Panel reference</a> , see page 202) saved by the control system for the location where the control returns is used as the reference. (Selection not available for parameter <a href="#">71.16 Setpoint 1 source</a> .)  <i>Reference</i> 	13
	Control panel (ref copied)	Control panel reference ( <a href="#">03.01 Panel reference</a> , see page 202) for the previous control location is used as the reference when the control location changes if the references for the two locations are of the same type (for example, frequency/speed/torque/PID); otherwise, the actual signal is used as the new reference.  <i>Reference</i> 	14
	FB A ref1	<a href="#">03.05 FB A reference 1</a> (see page 202).	15
	FB A ref2	<a href="#">03.06 FB A reference 2</a> (see page 202).	16
	Reserved		17...18
	EFB ref1	<a href="#">03.09 EFB reference 1</a> (see page 202).	19
	EFB ref2	<a href="#">03.10 EFB reference 2</a> (see page 203).	20
	Reserved		21...23
	Setpoint data storage	<a href="#">40.92 Setpoint data storage</a> (see page 368). (Selection not available for parameter <a href="#">71.16 Setpoint 1 source</a> .)	24

No.	Name/Value	Description	Def/FbEq16															
	<i>Other</i>	Source selection (see <a href="#">Terms and abbreviations</a> on page 196).	-															
40.17	<a href="#">Set 1 setpoint 2 source</a>	Selects the second source of process setpoint. The second source is used only if the setpoint function requires two inputs. For the selections, see parameter <a href="#">40.16 Set 1 setpoint 1 source</a> .	<i>Not selected</i>															
40.18	<a href="#">Set 1 setpoint function</a>	Selects a function between the setpoint sources selected by parameters <a href="#">40.16 Set 1 setpoint 1 source</a> and <a href="#">40.17 Set 1 setpoint 2 source</a> . The result of the function (for any selection) is multiplied by parameter <a href="#">40.89 Set 1 setpoint multiplier</a> .	<i>In1</i>															
	In1	Source 1.	0															
	In1+In2	Sum of sources 1 and 2.	1															
	In1-In2	Source 2 subtracted from source 1.	2															
	In1*In2	Source 1 multiplied by source 2.	3															
	In1/In2	Source 1 divided by source 2.	4															
	MIN(In1,In2)	Smaller of the two sources.	5															
	MAX(In1,In2)	Greater of the two sources.	6															
	AVE(In1,In2)	Average of the two sources.	7															
	sqrt(In1)	Square root of source 1.	8															
	sqrt(In1-In2)	Square root of (source 1 - source 2).	9															
	sqrt(In1+In2)	Square root of (source 1 + source 2).	10															
	sqrt(In1)+sqrt(In2)	Square root of source 1 + square root of source 2.	11															
40.19	<a href="#">Set 1 internal setpoint sel1</a>	Selects together with <a href="#">40.20 Set 1 internal setpoint sel2</a> the internal setpoint out of the presets defined by parameters <a href="#">40.21...40.24</a> . <b>Note:</b> Parameters <a href="#">40.16 Set 1 setpoint 1 source</a> and <a href="#">40.17 Set 1 setpoint 2 source</a> must be set to <i>Internal setpoint</i> .	<i>Not selected</i>															
		<table border="1"> <thead> <tr> <th>Source defined by par. 40.19</th> <th>Source defined by par. 40.20</th> <th>Setpoint preset active</th> </tr> </thead> <tbody> <tr> <td>0</td> <td>0</td> <td>0 (par. 40.24)</td> </tr> <tr> <td>1</td> <td>0</td> <td>1 (par. 40.21)</td> </tr> <tr> <td>0</td> <td>1</td> <td>2 (par. 40.22)</td> </tr> <tr> <td>1</td> <td>1</td> <td>3 (par. 40.23)</td> </tr> </tbody> </table>	Source defined by par. 40.19	Source defined by par. 40.20	Setpoint preset active	0	0	0 (par. 40.24)	1	0	1 (par. 40.21)	0	1	2 (par. 40.22)	1	1	3 (par. 40.23)	
Source defined by par. 40.19	Source defined by par. 40.20	Setpoint preset active																
0	0	0 (par. 40.24)																
1	0	1 (par. 40.21)																
0	1	2 (par. 40.22)																
1	1	3 (par. 40.23)																
	Not selected	0.	0															
	Selected	1.	1															
	DI1	Digital input DI1 ( <a href="#">10.02 DI delayed status</a> , bit 0).	2															
	DI2	Digital input DI2 ( <a href="#">10.02 DI delayed status</a> , bit 1).	3															
	DI3	Digital input DI3 ( <a href="#">10.02 DI delayed status</a> , bit 2).	4															
	DI4	Digital input DI4 ( <a href="#">10.02 DI delayed status</a> , bit 3).	5															
	DI5	Digital input DI5 ( <a href="#">10.02 DI delayed status</a> , bit 4).	6															
	DI6	Digital input DI6 ( <a href="#">10.02 DI delayed status</a> , bit 5).	7															
	Reserved		8...17															
	Timed function 1	Bit 0 of <a href="#">34.01 Timed functions status</a> (see page 327).	18															
	Timed function 2	Bit 1 of <a href="#">34.01 Timed functions status</a> (see page 327).	19															

No.	Name/Value	Description	Def/FbEq16
	Timed function 3	Bit 2 of <a href="#">34.01 Timed functions status</a> (see page <a href="#">327</a> ).	20
	Supervision 1	Bit 0 of <a href="#">32.01 Supervision status</a> (see page <a href="#">319</a> ).	21
	Supervision 2	Bit 1 of <a href="#">32.01 Supervision status</a> (see page <a href="#">319</a> ).	22
	Supervision 3	Bit 2 of <a href="#">32.01 Supervision status</a> (see page <a href="#">319</a> ).	23
	<i>Other [bit]</i>	Source selection (see <a href="#">Terms and abbreviations</a> on page <a href="#">196</a> ).	-
<a href="#">40.20</a>	<a href="#">Set 1 internal setpoint sel2</a>	Selects together with <a href="#">40.19 Set 1 internal setpoint sel1</a> the internal setpoint used out of the three internal setpoints defined by parameters <a href="#">40.21...40.23</a> . See table at <a href="#">40.19 Set 1 internal setpoint sel1</a> .	<i>Not selected</i>
	Not selected	0.	0
	Selected	1.	1
	DI1	Digital input DI1 ( <a href="#">10.02 DI delayed status</a> , bit 0).	2
	DI2	Digital input DI2 ( <a href="#">10.02 DI delayed status</a> , bit 1).	3
	DI3	Digital input DI3 ( <a href="#">10.02 DI delayed status</a> , bit 2).	4
	DI4	Digital input DI4 ( <a href="#">10.02 DI delayed status</a> , bit 3).	5
	DI5	Digital input DI5 ( <a href="#">10.02 DI delayed status</a> , bit 4).	6
	DI6	Digital input DI6 ( <a href="#">10.02 DI delayed status</a> , bit 5).	7
	Reserved		8...17
	Timed function 1	Bit 0 of <a href="#">34.01 Timed functions status</a> (see page <a href="#">327</a> ).	18
	Timed function 2	Bit 1 of <a href="#">34.01 Timed functions status</a> (see page <a href="#">327</a> ).	19
	Timed function 3	Bit 2 of <a href="#">34.01 Timed functions status</a> (see page <a href="#">327</a> ).	20
	Supervision 1	Bit 0 of <a href="#">32.01 Supervision status</a> (see page <a href="#">319</a> ).	21
	Supervision 2	Bit 1 of <a href="#">32.01 Supervision status</a> (see page <a href="#">319</a> ).	22
	Supervision 3	Bit 2 of <a href="#">32.01 Supervision status</a> (see page <a href="#">319</a> ).	23
	<i>Other [bit]</i>	Source selection (see <a href="#">Terms and abbreviations</a> on page <a href="#">196</a> ).	-
<a href="#">40.21</a>	<a href="#">Set 1 internal setpoint 1</a>	Internal process setpoint 1. See parameter <a href="#">40.19 Set 1 internal setpoint sel1</a> .	0.00 PID customer units
	-200000.00... 200000.00 PID customer units	Internal process setpoint 1.	1 = 1 PID customer unit
<a href="#">40.22</a>	<a href="#">Set 1 internal setpoint 2</a>	Internal process setpoint 2. See parameter <a href="#">40.19 Set 1 internal setpoint sel1</a> .	0.00 PID customer units
	-200000.00... 200000.00PID customer units	Internal process setpoint 2.	1 = 1 PID customer unit
<a href="#">40.23</a>	<a href="#">Set 1 internal setpoint 3</a>	Internal process setpoint 3. See parameter <a href="#">40.19 Set 1 internal setpoint sel1</a> .	0.00 PID customer units
	-200000.00... 200000.00 PID customer units	Internal process setpoint 3.	1 = 1 PID customer unit

No.	Name/Value	Description	Def/FbEq16
40.24	<a href="#">Set 1 internal setpoint 0</a>	Internal process setpoint 0. See parameter <a href="#">40.19 Set 1 internal setpoint sel1</a> .	0.00 PID customer units
	-200000.00... 200000.00 PID customer units	Internal process setpoint 0.	1 = 1 PID customer unit
40.26	<a href="#">Set 1 setpoint min</a>	Defines a minimum limit for the process PID controller setpoint.	0.00 PID customer units
	-200000.00... 200000.00 PID customer units	Minimum limit for process PID controller setpoint.	1 = 1 PID customer unit
40.27	<a href="#">Set 1 setpoint max</a>	Defines a maximum limit for the process PID controller setpoint.	200000.00 PID customer units
	-200000.00... 200000.00 PID customer units	Maximum limit for process PID controller setpoint.	1 = 1 PID customer unit
40.28	<a href="#">Set 1 setpoint increase time</a>	Defines the minimum time it takes for the setpoint to increase from 0% to 100%.	0.0 s
	0.0...1800.0 s	Setpoint increase time.	1 = 1
40.29	<a href="#">Set 1 setpoint decrease time</a>	Defines the minimum time it takes for the setpoint to decrease from 100% to 0%.	0.0 s
	0.0...1800.0 s	Setpoint decrease time.	1 = 1
40.30	<a href="#">Set 1 setpoint freeze enable</a>	Freezes, or defines a source that can be used to freeze, the setpoint of the process PID controller. This feature is useful when the reference is based on a process feedback connected to an analog input, and the sensor must be serviced without stopping the process. 1 = Process PID controller setpoint frozen See also parameter <a href="#">40.38 Set 1 output freeze enable</a> .	<i>Not selected</i>
	Not selected	Process PID controller setpoint not frozen.	0
	Selected	Process PID controller setpoint frozen.	1
	DI1	Digital input DI1 ( <a href="#">10.02 DI delayed status</a> , bit 0).	2
	DI2	Digital input DI2 ( <a href="#">10.02 DI delayed status</a> , bit 1).	3
	DI3	Digital input DI3 ( <a href="#">10.02 DI delayed status</a> , bit 2).	4
	DI4	Digital input DI4 ( <a href="#">10.02 DI delayed status</a> , bit 3).	5
	DI5	Digital input DI5 ( <a href="#">10.02 DI delayed status</a> , bit 4).	6
	DI6	Digital input DI6 ( <a href="#">10.02 DI delayed status</a> , bit 5).	7
	Reserved		8...17
	Timed function 1	Bit 0 of <a href="#">34.01 Timed functions status</a> (see page <a href="#">327</a> ).	18
	Timed function 2	Bit 1 of <a href="#">34.01 Timed functions status</a> (see page <a href="#">327</a> ).	19
	Timed function 3	Bit 2 of <a href="#">34.01 Timed functions status</a> (see page <a href="#">327</a> ).	20
	Supervision 1	Bit 0 of <a href="#">32.01 Supervision status</a> (see page <a href="#">319</a> ).	21
	Supervision 2	Bit 1 of <a href="#">32.01 Supervision status</a> (see page <a href="#">319</a> ).	22
	Supervision 3	Bit 2 of <a href="#">32.01 Supervision status</a> (see page <a href="#">319</a> ).	23
	<a href="#">Other [bit]</a>	Source selection (see <a href="#">Terms and abbreviations</a> on page <a href="#">196</a> ).	-

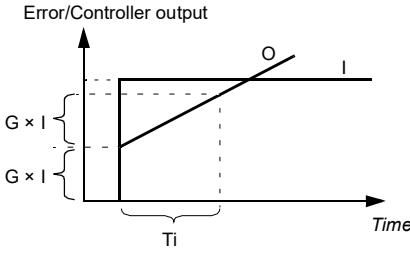
No.	Name/Value	Description	Def/FbEq16
40.31	<a href="#">Set 1 deviation inversion</a>	Inverts the input of the process PID controller. 0 = Deviation not inverted (Deviation = Setpoint - Feedback) 1 = Deviation inverted (Deviation = Feedback - Setpoint) See also section <a href="#">Sleep and boost functions for process PID control</a> (page 132).	<i>Not inverted (Ref - Fbk)</i>
	Not inverted (Ref - Fbk)	0.	0
	Inverted (Fbk - Ref)	1.	1
	<i>Other [bit]</i>	Source selection (see <a href="#">Terms and abbreviations</a> on page 196).	-
40.32	<a href="#">Set 1 gain</a>	Defines the gain for the process PID controller. See parameter <a href="#">40.33 Set 1 integration time</a> .	1.00
	0.01...100.00	Gain for PID controller.	100 = 1
40.33	<a href="#">Set 1 integration time</a>	Defines the integration time for the process PID controller. This time needs to be set to the same order of magnitude as the reaction time of the process being controlled, otherwise instability will result.   <p>I = controller input (error) O = controller output G = gain Ti = integration time</p> <p><b>Note:</b> Setting this value to 0 disables the "I" part, turning the PID controller into a PD controller.</p>	60.0 s
	0.0...9999.0 s	Integration time.	1 = 1 s
40.34	<a href="#">Set 1 derivation time</a>	Defines the derivation time of the process PID controller. The derivative component at the controller output is calculated on basis of two consecutive error values ( $E_{K-1}$ and $E_K$ ) according to the following formula: PID DERIV TIME $\times (E_K - E_{K-1})/T_S$ , in which $T_S = 2$ ms sample time E = Error = Process reference - process feedback.	0.000 s
	0.000...10.000 s	Derivation time.	1000 = 1 s

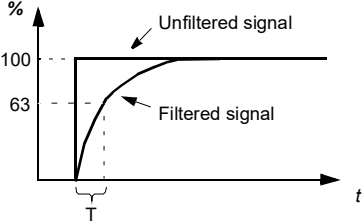

No.	Name/Value	Description	Def/FbEq16
40.35	<i>Set 1 derivation filter time</i>	<p>Defines the time constant of the 1-pole filter used to smooth the derivative component of the process PID controller.</p>  $O = I \times (1 - e^{-t/T})$ <p>I = filter input (step) O = filter output t = time T = filter time constant</p>	0.0 s
	0.0...10.0 s	Filter time constant.	10 = 1 s
40.36	<i>Set 1 output min</i>	Defines the minimum limit for the process PID controller output. Using the minimum and maximum limits, it is possible to restrict the operation range.	0.00
	-200000.00... 200000.00	Minimum limit for process PID controller output.	1 = 1
40.37	<i>Set 1 output max</i>	Defines the maximum limit for the process PID controller output. See parameter <a href="#">40.36 Set 1 output min</a> .	100.00
	-200000.00... 200000.00	Maximum limit for process PID controller output.	1 = 1
40.38	<i>Set 1 output freeze enable</i>	Freezes (or defines a source that can be used to freeze) the output of the process PID controller, keeping the output at the value it was before freeze was enabled. This feature can be used when, for example, a sensor providing process feedback must to be serviced without stopping the process. 1 = Process PID controller output frozen See also parameter <a href="#">40.30 Set 1 setpoint freeze enable</a> .	<i>Not selected</i>
	Not selected	Process PID controller output not frozen.	0
	Selected	Process PID controller output frozen.	1
	DI1	Digital input DI1 ( <a href="#">10.02 DI delayed status</a> , bit 0).	2
	DI2	Digital input DI2 ( <a href="#">10.02 DI delayed status</a> , bit 1).	3
	DI3	Digital input DI3 ( <a href="#">10.02 DI delayed status</a> , bit 2).	4
	DI4	Digital input DI4 ( <a href="#">10.02 DI delayed status</a> , bit 3).	5
	DI5	Digital input DI5 ( <a href="#">10.02 DI delayed status</a> , bit 4).	6
	DI6	Digital input DI6 ( <a href="#">10.02 DI delayed status</a> , bit 5).	7
	Reserved		8...17
	Timed function 1	Bit 0 of <a href="#">34.01 Timed functions status</a> (see page <a href="#">327</a> ).	18
	Timed function 2	Bit 1 of <a href="#">34.01 Timed functions status</a> (see page <a href="#">327</a> ).	19
	Timed function 3	Bit 2 of <a href="#">34.01 Timed functions status</a> (see page <a href="#">327</a> ).	20

No.	Name/Value	Description	Def/FbEq16
	Supervision 1	Bit 0 of <a href="#">32.01 Supervision status</a> (see page 319).	21
	Supervision 2	Bit 1 of <a href="#">32.01 Supervision status</a> (see page 319).	22
	Supervision 3	Bit 2 of <a href="#">32.01 Supervision status</a> (see page 319).	23
	<i>Other [bit]</i>	Source selection (see <a href="#">Terms and abbreviations</a> on page 196).	-
40.39	<i>Set 1 deadband range</i>	Defines a deadband around the setpoint. Whenever process feedback enters the deadband, a delay timer starts. If the feedback remains within the deadband longer than the delay ( <a href="#">40.40 Set 1 deadband delay</a> ), the PID controller output is frozen. Normal operation resumes after the feedback value leaves the deadband.	0.0 PID customer unit

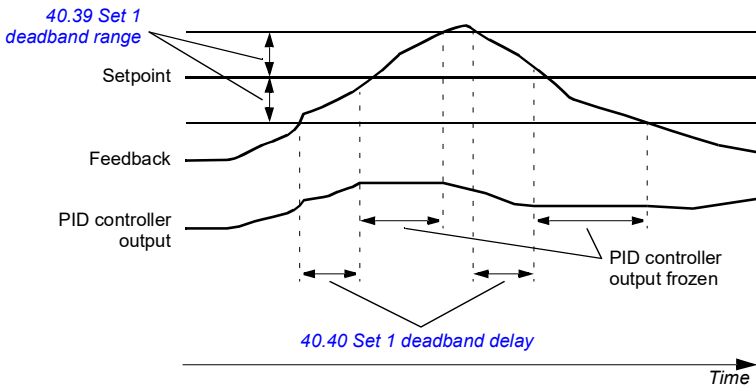

	0.....200000.0 PID customer units	Deadband range.	1 = 1 PID customer unit
40.40	<i>Set 1 deadband delay</i>	Delay for the deadband. See parameter <a href="#">40.39 Set 1 deadband range</a> .	0.0 s
	0.0 ... 3600.0 s	Delay for deadband area.	1 = 1 s
40.43	<i>Set 1 sleep level</i>	Defines the start limit for the sleep function. If the value is 0.0, set 1 sleep mode is disabled. The sleep function compares PID output (parameter <a href="#">40.01 Process PID output actual</a> ) to the value of this parameter. If PID output remains below this value longer than the sleep delay defined by <a href="#">40.44 Set 1 sleep delay</a> , the drive enters the sleep mode and stops the motor.	0.0
	0.0...200000.0	Sleep start level.	1 = 1
40.44	<i>Set 1 sleep delay</i>	Defines a delay before the sleep function actually becomes enabled, to prevent nuisance sleeping. The delay timer starts when the sleep mode is enabled by parameter <a href="#">40.43 Set 1 sleep level</a> , and resets when the sleep mode is disabled.	60.0 s
	0.0...3600.0 s	Sleep start delay.	1 = 1 s
40.45	<i>Set 1 sleep boost time</i>	Defines a boost time for the sleep boost step. See parameter <a href="#">40.46 Set 1 sleep boost step</a> .	0.0 s
	0.0...3600.0 s	Sleep boost time.	1 = 1 s

No.	Name/Value	Description	Def/FbEq16
40.46	<i>Set 1 sleep boost step</i>	When the drive is entering sleep mode, the process setpoint is increased by this value for the time defined by parameter <a href="#">40.45 Set 1 sleep boost time</a> . If active, sleep boost is aborted when the drive wakes up.	0.0 PID customer units
	0.0...200000.0 PID customer units	Sleep boost step.	1 = 1 PID customer unit
40.47	<i>Set 1 wake-up deviation</i>	Defines the wake-up level as deviation between process setpoint and feedback. When the deviation exceeds the value of this parameter, and remains there for the duration of the wake-up delay ( <a href="#">40.48 Set 1 wake-up delay</a> ), the drive wakes up. See also parameter <a href="#">40.31 Set 1 deviation inversion</a> .	0.00 PID customer units
	-200000.00...200000.00 PID customer units	Wake-up level (as deviation between process setpoint and feedback).	1 = 1 PID customer unit
40.48	<i>Set 1 wake-up delay</i>	Defines a wake-up delay for the sleep function to prevent nuisance wake-ups. See parameter <a href="#">40.47 Set 1 wake-up deviation</a> . The delay timer starts when the deviation exceeds the wake-up level ( <a href="#">40.47 Set 1 wake-up deviation</a> ), and resets if the deviation falls below the wake-up level.	0.50 s
	0.00...60.00 s	Wake-up delay.	1 = 1 s
40.49	<i>Set 1 tracking mode</i>	Activates (or selects a source that activates) tracking mode. In tracking mode, the value selected by parameter <a href="#">40.50 Set 1 tracking ref selection</a> is substituted for the PID controller output. See also section <a href="#">Tracking</a> (page 134). 1 = Tracking mode enabled	<i>Not selected</i>
	Not selected	0.	0
	Selected	1.	1
	DI1	Digital input DI1 ( <a href="#">10.02 DI delayed status</a> , bit 0).	2
	DI2	Digital input DI2 ( <a href="#">10.02 DI delayed status</a> , bit 1).	3
	DI3	Digital input DI3 ( <a href="#">10.02 DI delayed status</a> , bit 2).	4
	DI4	Digital input DI4 ( <a href="#">10.02 DI delayed status</a> , bit 3).	5
	DI5	Digital input DI5 ( <a href="#">10.02 DI delayed status</a> , bit 4).	6
	DI6	Digital input DI6 ( <a href="#">10.02 DI delayed status</a> , bit 5).	7
	Reserved		8...17
	Timed function 1	Bit 0 of <a href="#">34.01 Timed functions status</a> (see page 327).	18
	Timed function 2	Bit 1 of <a href="#">34.01 Timed functions status</a> (see page 327).	19
	Timed function 3	Bit 2 of <a href="#">34.01 Timed functions status</a> (see page 327).	20
	Supervision 1	Bit 0 of <a href="#">32.01 Supervision status</a> (see page 319).	21
	Supervision 2	Bit 1 of <a href="#">32.01 Supervision status</a> (see page 319).	22
	Supervision 3	Bit 2 of <a href="#">32.01 Supervision status</a> (see page 319).	23
	<i>Other [bit]</i>	Source selection (see <a href="#">Terms and abbreviations</a> on page 196).	-
40.50	<i>Set 1 tracking ref selection</i>	Selects the value source for tracking mode. See parameter <a href="#">40.49 Set 1 tracking mode</a> .	<i>Not selected</i>
	Not selected	None.	0
	AI1 scaled	<a href="#">12.12 AI1 scaled value</a> (see page 227).	1
	AI2 scaled	<a href="#">12.22 AI2 scaled value</a> (see page 229).	2

No.	Name/Value	Description	Def/FbEq16
	FB A ref1	<a href="#">03.05 FB A reference 1</a> (see page <a href="#">202</a> ).	3
	FB A ref2	<a href="#">03.06 FB A reference 2</a> (see page <a href="#">202</a> ).	4
	<i>Other</i>	Source selection (see <a href="#">Terms and abbreviations</a> on page <a href="#">196</a> ).	-
<a href="#">40.51</a>	<a href="#">Set 1 trim mode</a>	Activates the trim function and selects between direct and proportional trimming (or a combination of both). With trimming, it is possible to apply a corrective factor to the drive reference (setpoint). The output after trimming is available as parameter <a href="#">40.05 Process PID trim output act</a> . See section <a href="#">PID trim function</a> (page <a href="#">135</a> ), and the control chain diagram on page <a href="#">564</a> .	<i>Off</i>
	Off	The trim function is inactive.	0
	Direct	The trim function is active. The trimming factor is relative to the maximum speed, torque or frequency; the selection between these is made by parameter <a href="#">40.52 Set 1 trim selection</a> .	1
	Proportional	The trim function is active. The trimming factor is relative to the reference selected by parameter <a href="#">40.53 Set 1 trimmed ref pointer</a> .	2
	Combined	The trim function is active. The trimming factor is a combination of both <i>Direct</i> and <i>Proportional</i> modes; the proportions of each are defined by parameter <a href="#">40.54 Set 1 trim mix</a> .	3
<a href="#">40.52</a>	<a href="#">Set 1 trim selection</a>	Selects whether trimming is used for correcting the speed, torque or frequency reference.	<i>Speed</i>
	Torque	Torque reference trimming.	1
	Speed	Speed reference trimming.	2
	Frequency	Frequency reference trimming.	3
<a href="#">40.53</a>	<a href="#">Set 1 trimmed ref pointer</a>	Selects the signal source for the trim reference.	<i>Not selected</i>
	Not selected	None.	0
	AI1 scaled	<a href="#">12.12 AI1 scaled value</a> (see page <a href="#">227</a> ).	1
	AI2 scaled	<a href="#">12.22 AI2 scaled value</a> (see page <a href="#">229</a> ).	2
	FB A ref1	<a href="#">03.05 FB A reference 1</a> (see page <a href="#">202</a> ).	3
	FB A ref2	<a href="#">03.06 FB A reference 2</a> (see page <a href="#">202</a> ).	4
	<i>Other</i>	Source selection (see <a href="#">Terms and abbreviations</a> on page <a href="#">196</a> ).	-
<a href="#">40.54</a>	<a href="#">Set 1 trim mix</a>	When parameter <a href="#">40.51 Set 1 trim mode</a> is set to <i>Combined</i> , defines the effect of direct and proportional trim sources in the final trimming factor. 0.000 = 100% proportional 0.500 = 50% proportional, 50% direct 1.000 = 100% direct	0.000
	0.000 ... 1.000	Trim mix.	1 = 1
<a href="#">40.55</a>	<a href="#">Set 1 trim adjust</a>	Defines a multiplier for the trimming factor. This value is multiplied by the result of parameter <a href="#">40.51 Set 1 trim mode</a> . Consequently, the result of the multiplication is used to multiply the result of parameter <a href="#">40.56 Set 1 trim source</a> .	1.000
	-100.000 ... 100.000	Multiplier for trimming factor.	1 = 1

No.	Name/Value	Description	Def/FbEq16
40.56	<i>Set 1 trim source</i>	Selects the reference to be trimmed.	<i>PID output</i>
	PID ref	PID setpoint.	1
	PID output	PID controller output.	2
40.57	<i>PID set1/set2 selection</i>	Selects the source that determines whether process PID parameter set 1 (parameters 40.07...40.50) or set 2 (group 41 Process PID set 2) is used.	<i>PID set 1</i>
	PID set 1	0. Process PID parameter set 1 in use.	0
	PID set 2	1. Process PID parameter set 2 in use.	1
	DI1	Digital input DI1 ( <i>10.02 DI delayed status</i> , bit 0).	2
	DI2	Digital input DI2 ( <i>10.02 DI delayed status</i> , bit 1).	3
	DI3	Digital input DI3 ( <i>10.02 DI delayed status</i> , bit 2).	4
	DI4	Digital input DI4 ( <i>10.02 DI delayed status</i> , bit 3).	5
	DI5	Digital input DI5 ( <i>10.02 DI delayed status</i> , bit 4).	6
	DI6	Digital input DI6 ( <i>10.02 DI delayed status</i> , bit 5).	7
	Reserved		8...17
	Timed function 1	Bit 0 of <i>34.01 Timed functions status</i> (see page 327).	18
	Timed function 2	Bit 1 of <i>34.01 Timed functions status</i> (see page 327).	19
	Timed function 3	Bit 2 of <i>34.01 Timed functions status</i> (see page 327).	20
	Supervision 1	Bit 0 of <i>32.01 Supervision status</i> (see page 319).	21
	Supervision 2	Bit 1 of <i>32.01 Supervision status</i> (see page 319).	22
	Supervision 3	Bit 2 of <i>32.01 Supervision status</i> (see page 319).	23
	<i>Other [bit]</i>	Source selection (see <i>Terms and abbreviations</i> on page 196).	-
40.58	<i>Set 1 increase prevention</i>	Activates and defines the type of the prevention of PID integration term increase for PID set 1.	<i>No</i>
	No	Increase prevention not in use.	0
	Limiting	The PID integration term is not increased if the maximum value for the PID output is reached. This parameter is valid for the PID set 1.	1
	Ext PID min lim	The process PID integration term is not increased when the output of the external PID has reached its minimum limit. In this setup, the external PID is used as a source for the process PID. This parameter is valid for the PID set 1.	2
	Ext PID max lim	The process PID integration term is not increased when the output of the external PID has reached its maximum limit. In this setup, the external PID is used as a source for the process PID. This parameter is valid for the PID set 1.	3
	<i>Other [bit]</i>	Source selection (see <i>Terms and abbreviations</i> on page 196).	-
40.59	<i>Set 1 decrease prevention</i>	Prevention of PID integration term decrease for PID set 1.	<i>No</i>
	No	Decrease prevention not in use.	0
	Limiting	The PID integration term is not decreased if the minimum value for the PID output is reached. This parameter is valid for the PID set 1.	1
	Ext PID min lim	The process PID integration term is not decreased when the output of the external PID has reached its minimum limit. In this setup, the external PID is used as a source for the process PID. This parameter is valid for the PID set 1.	2

## 366 Parameters

No.	Name/Value	Description	Def/FbEq16
	Ext PID max lim	The process PID integration term is not decreased when the output of the external PID has reached its maximum limit. In this setup, the external PID is used as a source for the process PID. This parameter is valid for the PID set 1.	3
40.60	<i>Set 1 PID activation source</i>	Selects a source that enables/disables process PID control. See also parameter <a href="#">40.07 Process PID operation mode</a> . 0 = Process PID control disabled. 1 = Process PID control enabled.	On
	Off	0.	0
	On	1.	1
	Follow Ext1/Ext2 selection	Process PID control is disabled when external control location EXT1 is active, and enabled when external control location EXT2 is active. See also parameter <a href="#">19.11 Ext1/Ext2 selection</a> .	2
	DI1	Digital input DI1 ( <a href="#">10.02 DI delayed status</a> , bit 0).	3
	DI2	Digital input DI2 ( <a href="#">10.02 DI delayed status</a> , bit 1).	4
	DI3	Digital input DI3 ( <a href="#">10.02 DI delayed status</a> , bit 2).	5
	DI4	Digital input DI4 ( <a href="#">10.02 DI delayed status</a> , bit 3).	6
	DI5	Digital input DI5 ( <a href="#">10.02 DI delayed status</a> , bit 4).	7
	DI6	Digital input DI6 ( <a href="#">10.02 DI delayed status</a> , bit 5).	8
	<i>Other [bit]</i>	Source selection (see <a href="#">Terms and abbreviations</a> on page 196).	-
40.61	<i>Setpoint scaling actual</i>	Actual setpoint scaling. See parameter <a href="#">40.14 Set 1 setpoint scaling</a> .	100.00
	-200000.00... 200000.00	Scaling.	1 = 1
40.62	<i>PID internal setpoint actual</i>	Displays the value of the internal setpoint. See the control chain diagram on page 563. This parameter is read-only.	-
	-200000.00... 200000.00 PID customer units	Process PID internal setpoint.	1 = 1 PID customer unit
40.65	<i>Trim auto connection</i>	Enables the PID trim auto connection and connects PID trim <a href="#">40.05 Process PID trim output act</a> to either speed, torque or frequency chains, based on the trim selection parameter <a href="#">40.52 Set 1 trim selection</a> or <a href="#">41.52 Set 2 trim selection</a> . See control chain diagram on page 568.	Disable
	Disable	Disable PID trim auto connection.	0
	Enable	Enable PID trim auto connection.	1
40.79	<i>Set 1 units</i>	Unit used for PID set 1.	°C
	User text	User editable text. User text default is "PID unit 1".	0
	%		4
	bar		74
	kPa		75
	Pa		77
	psi		76
	CFM		26
	inH <sub>2</sub> O		58

No.	Name/Value	Description	Def/FbEq16
	°C		150
	°F		151
	mbar		44
	m <sup>3</sup> /h		78
	dm <sup>3</sup> /h		21
	l/s		79
	l/min		37
	l/h		38
	m <sup>3</sup> /s		88
	m <sup>3</sup> /min		40
	km <sup>3</sup> /h		131
	gal/s		47
	ft <sup>3</sup> /s		50
	ft <sup>3</sup> /min		51
	ft <sup>3</sup> /h		52
	ppm		34
	inHg		29
	kCFM		126
	inWC		85
	gpm		80
	gal/min		48
	in wg		59
	MPa		94
	ftWC		125
	%		4
	bar		74
	kPa		75
	Pa		77
	psi		76
	CFM		26
	inH <sub>2</sub> O		58
	°C		150
	°F		151
	mbar		44
	m <sup>3</sup> /h		78
	dm <sup>3</sup> /h		21
	l/s		79
	l/min		37
	l/h		38
	m <sup>3</sup> /s		88
	m <sup>3</sup> /min		40

No.	Name/Value	Description	Def/FbEq16
	km <sup>3</sup> /h		131
	gal/s		47
	ft <sup>3</sup> /s		50
	ft <sup>3</sup> /min		51
	ft <sup>3</sup> /h		52
	ppm		34
	inHg		29
	kCFM		126
	inWC		65
	gpm		80
	gal/min		48
	in wg		59
	MPa		94
	ftWC		125
40.80	<i>Set 1 PID output min source</i>	Selects the source for set 1 PID output minimum.	<i>Set1 output min</i>
	None	Not selected.	0
	Set1 output min	<a href="#">40.36 Set 1 output min.</a>	1
40.81	<i>Set 1 PID output max source</i>	Selects the source for set 1 PID output maximum.	<i>Set1 output max</i>
	None	Not selected.	0
	Set1 output max	<a href="#">40.37 Set 1 output max</a>	1
40.89	<i>Set 1 setpoint multiplier</i>	Defines the multiplier with which the result of the function specified by parameter <a href="#">40.18 Set 1 setpoint function</a> is multiplied.	1.00
	-200000.00... 200000.00	Multiplier.	1 = 1
40.90	<i>Set 1 feedback multiplier</i>	Defines the multiplier with which the result of the function specified by parameter <a href="#">40.10 Set 1 feedback function</a> is multiplied.	1.00
	-200000.00... 200000.00	Multiplier.	1 = 1
40.91	<i>Feedback data storage</i>	Storage parameter for receiving a process feedback value, for example, through the embedded fieldbus interface. The value can be sent to the drive as Modbus I/O data. Set the target selection parameter of that particular data ( <a href="#">58.101...58.114</a> ) to <a href="#">Feedback data storage</a> . In <a href="#">40.08 Set 1 feedback 1 source</a> (or <a href="#">40.09 Set 1 feedback 2 source</a> ), select <a href="#">Feedback data storage</a> .	-
	-327.68...327.67	Storage parameter for process feedback.	100 = 1
40.92	<i>Setpoint data storage</i>	Storage parameter for receiving a process setpoint value, for example, through the embedded fieldbus interface. The value can be sent to the drive as Modbus I/O data. Set the target selection parameter of that particular data ( <a href="#">58.101...58.114</a> ) to <a href="#">Setpoint data storage</a> . In <a href="#">40.16 Set 1 setpoint 1 source</a> (or <a href="#">40.17 Set 1 setpoint 2 source</a> ), select <a href="#">Setpoint data storage</a> .	-
	-327.68...327.67	Storage parameter for process setpoint.	100 = 1



No.	Name/Value	Description	Def/FbEq16
40.96	<i>Process PID output %</i>	Percentage scaled signal of parameter <i>40.01 Process PID feedback actual</i> .	0.00%
	-100.00...100.00%	Percentage.	100 = 1%
40.97	<i>Process PID feedback %</i>	Percentage scaled signal of parameter <i>40.02 Process PID feedback actual</i> .	0.00%
	-100.00...100.00%	Percentage.	100 = 1%
40.98	<i>Process PID setpoint %</i>	Percentage scaled signal of parameter <i>40.03 Process PID setpoint actual</i> .	0.00%
	-100.00...100.00%	Percentage.	100 = 1%
40.99	<i>Process PID deviation %</i>	Percentage scaled signal of parameter <i>40.04 Process PID deviation actual</i> .	0.00%
	-100.00...100.00%	Percentage.	100 = 1%
<b>41 Process PID set 2</b>			
		A second set of parameter values for process PID control. The selection between this set and first set (parameter group <i>40 Process PID set 1</i> ) is made by parameter <i>40.57 PID set1/set2 selection</i> . See also parameters <i>40.01...40.06</i> , and the control chain diagrams on pages <i>563</i> and <i>564</i> .	
41.08	<i>Set 2 feedback 1 source</i>	See parameter <i>40.08 Set 1 feedback 1 source</i> .	<i>AI2 percent</i>
41.09	<i>Set 2 feedback 2 source</i>	See parameter <i>40.09 Set 1 feedback 2 source</i> .	<i>Not selected</i>
41.10	<i>Set 2 feedback function</i>	See parameter <i>40.10 Set 1 feedback function</i> .	<i>In1</i>
41.11	<i>Set 2 feedback filter time</i>	See parameter <i>40.11 Set 1 feedback filter time</i> .	0.000 s
41.14	<i>Set 2 setpoint scaling</i>	See parameter <i>40.14 Set 1 setpoint scaling</i> .	0.00
41.15	<i>Set 2 output scaling</i>	See parameter <i>40.15 Set 1 output scaling</i> .	0.00
41.16	<i>Set 2 setpoint 1 source</i>	See parameter <i>40.16 Set 1 setpoint 1 source</i> .	<i>AI1 percent</i>
41.17	<i>Set 2 setpoint 2 source</i>	See parameter <i>40.17 Set 1 setpoint 2 source</i> .	<i>Not selected</i>
41.18	<i>Set 2 setpoint function</i>	See parameter <i>40.18 Set 1 setpoint function</i> .	<i>In1</i>
41.19	<i>Set 2 internal setpoint sel1</i>	See parameter <i>40.19 Set 1 internal setpoint sel1</i> .	<i>Not selected</i>
41.20	<i>Set 2 internal setpoint sel2</i>	See parameter <i>40.20 Set 1 internal setpoint sel2</i> .	<i>Not selected</i>
41.21	<i>Set 2 internal setpoint 1</i>	See parameter <i>40.21 Set 1 internal setpoint 1</i> .	0.00 PID customer units
41.22	<i>Set 2 internal setpoint 2</i>	See parameter <i>40.22 Set 1 internal setpoint 2</i> .	0.00 PID customer units
41.23	<i>Set 2 internal setpoint 3</i>	See parameter <i>40.23 Set 1 internal setpoint 3</i> .	0.00 PID customer units

## 370 Parameters

No.	Name/Value	Description	Def/FbEq16
41.24	<i>Set 2 internal setpoint 0</i>	40.24 <i>Set 1 internal setpoint 0.</i>	0.00 PID customer units
41.26	<i>Set 2 setpoint min</i>	See parameter 40.26 <i>Set 1 setpoint min.</i>	0.00 PID customer units
41.27	<i>Set 2 setpoint max</i>	See parameter 40.27 <i>Set 1 setpoint max.</i>	200000.00 PID customer units
41.28	<i>Set 2 setpoint increase time</i>	See parameter 40.28 <i>Set 1 setpoint increase time.</i>	0.0 s
41.29	<i>Set 2 setpoint decrease time</i>	See parameter 40.29 <i>Set 1 setpoint decrease time.</i>	0.0 s
41.30	<i>Set 2 setpoint freeze enable</i>	See parameter 40.30 <i>Set 1 setpoint freeze enable.</i>	<i>Not selected</i>
41.31	<i>Set 2 deviation inversion</i>	See parameter 40.31 <i>Set 1 deviation inversion.</i>	<i>Not inverted (Ref - Fbk)</i>
41.32	<i>Set 2 gain</i>	See parameter 40.32 <i>Set 1 gain.</i>	1.00
41.33	<i>Set 2 integration time</i>	See parameter 40.33 <i>Set 1 integration time.</i>	60.0 s
41.34	<i>Set 2 derivation time</i>	See parameter 40.34 <i>Set 1 derivation time.</i>	0.000 s
41.35	<i>Set 2 derivation filter time</i>	See parameter 40.35 <i>Set 1 derivation filter time.</i>	0.0 s
41.36	<i>Set 2 output min</i>	See parameter 40.36 <i>Set 1 output min.</i>	0.00
41.37	<i>Set 2 output max</i>	See parameter 40.37 <i>Set 1 output max.</i>	100.00
41.38	<i>Set 2 output freeze enable</i>	See parameter 40.38 <i>Set 1 output freeze enable.</i>	<i>Not selected</i>
41.39	<i>Set 2 deadband range</i>	See parameter 40.39 <i>Set 1 deadband range.</i>	0.0 PID customer units
41.40	<i>Set 2 deadband delay</i>	See parameter 40.40 <i>Set 1 deadband delay.</i>	0.0 s
41.43	<i>Set 2 sleep level</i>	See parameter 40.43 <i>Set 1 sleep level.</i>	0.0
41.44	<i>Set 2 sleep delay</i>	See parameter 40.44 <i>Set 1 sleep delay.</i>	60.0 s
41.45	<i>Set 2 sleep boost time</i>	See parameter 40.45 <i>Set 1 sleep boost time.</i>	0.0 s
41.46	<i>Set 2 sleep boost step</i>	See parameter 40.46 <i>Set 1 sleep boost step.</i>	0.0 PID customer units
41.47	<i>Set 2 wake-up deviation</i>	See parameter 40.47 <i>Set 1 wake-up deviation.</i>	0.00 PID customer units
41.48	<i>Set 2 wake-up delay</i>	See parameter 40.48 <i>Set 1 wake-up delay.</i>	0.50 s
41.49	<i>Set 2 tracking mode</i>	See parameter 40.49 <i>Set 1 tracking mode.</i>	<i>Not selected</i>
41.50	<i>Set 2 tracking ref selection</i>	See parameter 40.50 <i>Set 1 tracking ref selection.</i>	<i>Not selected</i>
41.51	<i>Set 2 trim mode</i>	See parameter 40.51 <i>Set 1 trim mode.</i>	<i>Off</i>

No.	Name/Value	Description	Def/FbEq16
41.52	<i>Set 2 trim selection</i>	See parameter <i>40.52 Set 1 trim selection</i> .	<i>Speed</i>
41.53	<i>Set 2 trimmed ref pointer</i>	See parameter <i>40.53 Set 1 trimmed ref pointer</i> .	<i>Not selected</i>
41.54	<i>Set 2 trim mix</i>	See parameter <i>40.54 Set 1 trim mix</i> .	-
41.55	<i>Set 2 trim adjust</i>	See parameter <i>40.55 Set 1 trim adjust</i> .	1.000
41.56	<i>Set 2 trim source</i>	See parameter <i>40.56 Set 1 trim source</i> .	<i>PID output</i>
41.58	<i>Set 2 increase prevention</i>	See parameter <i>40.58 Set 1 increase prevention</i> .	<i>No</i>
41.59	<i>Set 2 decrease prevention</i>	See parameter <i>40.59 Set 1 decrease prevention</i> .	<i>No</i>
41.60	<i>Set 2 PID activation source</i>	See parameter <i>40.60 Set 1 PID activation source</i> .	<i>On</i>
41.79	<i>Set 2 units</i>	See parameter <i>40.79 Set 1 units</i> .	°C
41.80	<i>Set 2 PID output min source</i>	Selects the source for set 2 PID output minimum.	<i>Set2 output min</i>
	None	Not selected.	0
	Set2 output min	<i>41.36 Set 2 output min</i> .	1
41.81	<i>Set 2 PID output max source</i>	Selects the source for set 2 PID output maximum.	<i>Set2 output max</i>
	None	Not selected.	0
	Set2 output max	<i>41.37 Set 2 output max</i>	1
41.89	<i>Set 2 setpoint multiplier</i>	See parameter <i>40.89 Set 1 setpoint multiplier</i> .	1.00
41.90	<i>Set 2 feedback multiplier</i>	Defines the multiplier k used in formulas of parameter <i>41.10 Set 2 feedback function</i> . See parameter <i>40.90 Set 1 feedback multiplier</i> .	1.00
<b>43 Brake chopper</b>		Settings for the internal brake chopper. <b>Note:</b> These parameters apply to internal brake chopper only. When using external brake, you must disable brake chopper function by setting parameter <i>43.06 Brake chopper function</i> to value <i>Disabled</i> .	
43.01	<i>Braking resistor temperature</i>	Displays the estimated temperature of the brake resistor, or how close the brake resistor is to being too hot. The value is given in percent where 100% is the eventual temperature the resistor would reach when loaded long enough with its rated maximum load capacity ( <i>43.09 Brake resistor Pmax cont</i> ). The temperature calculation is based on the values of parameters <i>43.08</i> , <i>43.09</i> and <i>43.10</i> , and on the assumption that the resistor is installed as instructed by the manufacturer (that is, it cools down as expected). This parameter is read-only.	-
	0.0...120.0%	Estimated brake resistor temperature.	1 = 1%

## 372 Parameters

No.	Name/Value	Description	Def/FbEq16
43.06	<i>Brake chopper function</i>	<p>Enables brake chopper control and selects the brake resistor overload protection method (calculation or measurement).</p> <p><b>Note:</b> Before enabling brake chopper control, ensure that</p> <ul style="list-style-type: none"> <li>a brake resistor is connected</li> <li>overvoltage control is switched off (parameter <a href="#">30.30 Overvoltage control</a>)</li> <li>the supply voltage range (parameter <a href="#">95.01 Supply voltage</a>) has been selected correctly.</li> </ul> <p><b>Note:</b> When using external brake chopper, set this parameter to value <i>Disabled</i>.</p>	<i>Disabled</i>
	Disabled	Brake chopper control disabled.	0
	Enabled with thermal model	Brake chopper control enabled with brake resistor protection based on the thermal model. If you select this, you must also specify the values needed by the model, ie. parameters <a href="#">43.08... 43.12</a> . See the resistor data sheet.	1
	Enabled without thermal model	Brake chopper control enabled without resistor overload protection based on the thermal model. This setting can be used, for example, if the resistor is equipped with a thermal switch that is wired to open the main contactor of the drive if the resistor overheats. For more information, see chapter <i>Resistor braking</i> in the <i>Hardware manual</i> of the drive	2
	Overvoltage peak protection	<p>Brake chopper control enabled in an overvoltage condition. This setting is intended for situations where</p> <ul style="list-style-type: none"> <li>the braking chopper is not needed for runtime operation, ie. to dissipate the inertial energy of the motor,</li> <li>the motor is able to store a considerable amount magnetic energy in its windings, and</li> <li>the motor might, deliberately or inadvertently, be stopped by coasting.</li> </ul> <p>In such a situation, the motor would potentially discharge enough magnetic energy towards the drive to cause damage. To protect the drive, the brake chopper can be used with a small resistor dimensioned merely to handle the magnetic energy (not the inertial energy) of the motor.</p> <p>With this setting, the brake chopper is activated only whenever the DC voltage exceeds the overvoltage limit. During normal use, the brake chopper is not operating.</p>	3
43.07	<i>Brake chopper run enable</i>	<p>Selects the source for quick brake chopper on/off control.</p> <p>0 = Brake chopper IGBT pulses are cut off 1 = Normal brake chopper IGBT modulation allowed.</p>	<i>On</i>
	Off	0.	0
	On	1.	1
	<i>Other [bit]</i>	Source selection (see <a href="#">Terms and abbreviations</a> on page 196).	-
43.08	<i>Brake resistor thermal tc</i>	Defines the thermal time constant for the brake resistor thermal model.	0 s
	0...10000 s	Brake resistor thermal time constant, that is, the rated time to achieve 63% temperature.	1 = 1 s

No.	Name/Value	Description	Def/FbEq16																																	
43.09	<i>Brake resistor Pmax cont</i>	Defines the maximum continuous load of the brake resistor that will eventually raise the resistor temperature to the maximum allowed value (= continuous heat dissipation capacity of the resistor in kW) but not above it. The value is used in the resistor overload protection based on the thermal model. See parameter <a href="#">43.06 Brake chopper function</a> and the data sheet of the brake resistor used.	0.00 kW																																	
	0.00... 10000.00 kW	Maximum continuous load of the brake resistor.	1 = 1 kW																																	
43.10	<i>Brake resistance</i>	Defines the resistance value of the brake resistor. The value is used for the brake resistor protection based on the thermal model. See parameter <a href="#">43.06 Brake chopper function</a> .	0.0 ohm																																	
	0.0...1000.0 ohm	Brake resistor resistance value.	1 = 1 ohm																																	
43.11	<i>Brake resistor fault limit</i>	Selects the fault limit for the brake resistor protection based on the thermal model. See parameter <a href="#">43.06 Brake chopper function</a> . When the limit is exceeded, the drive trips on fault <a href="#">7183 BR excess temperature</a> . The value is given in percent of the temperature the resistor reaches when loaded with the power defined by parameter <a href="#">43.09 Brake resistor Pmax cont</a> .	105%																																	
	0...150%	Brake resistor temperature fault limit.	1 = 1%																																	
43.12	<i>Brake resistor warning limit</i>	Selects the warning limit for the brake resistor protection based on the thermal model. See parameter <a href="#">43.06 Brake chopper function</a> . When the limit is exceeded, the drive generates a <a href="#">A793 BR excess temperature</a> warning. The value is given in percent of the temperature the resistor reaches when loaded with the power defined by parameter <a href="#">43.09 Brake resistor Pmax cont</a> .	95%																																	
	0...150%	Brake resistor temperature warning limit.	1 = 1%																																	
<b>44 Mechanical brake control</b>		Configuration of mechanical brake control. See also section <a href="#">Mechanical brake control</a> (page 152).																																		
44.01	<i>Brake control status</i>	Displays the mechanical brake control status word. This parameter is read-only.	-																																	
<table border="1"> <thead> <tr> <th>Bit</th> <th>Name</th> <th>Information</th> </tr> </thead> <tbody> <tr> <td>0</td> <td>Open command</td> <td>Close/open command to brake actuator (0 = close, 1 = open). Connect this bit to desired output.</td> </tr> <tr> <td>1</td> <td>Opening torque request</td> <td>1 = Opening torque requested from drive logic.</td> </tr> <tr> <td>2</td> <td>Hold stopped request</td> <td>1 = Hold requested from drive logic</td> </tr> <tr> <td>3</td> <td>Ramp to stopped</td> <td>1 = Ramping down to zero speed requested from drive logic</td> </tr> <tr> <td>4</td> <td>Enabled</td> <td>1 = Brake control is enabled</td> </tr> <tr> <td>5</td> <td>Closed</td> <td>1 = Brake control logic in <a href="#">BRAKE CLOSED</a> state</td> </tr> <tr> <td>6</td> <td>Opening</td> <td>1 = Brake control logic in <a href="#">BRAKE OPENING</a> state</td> </tr> <tr> <td>7</td> <td>Open</td> <td>1 = Brake control logic in <a href="#">BRAKE OPEN</a> state</td> </tr> <tr> <td>8</td> <td>Closing</td> <td>1 = Brake control logic in <a href="#">BRAKE CLOSING</a> state</td> </tr> <tr> <td>9...15</td> <td>Reserved</td> <td></td> </tr> </tbody> </table>				Bit	Name	Information	0	Open command	Close/open command to brake actuator (0 = close, 1 = open). Connect this bit to desired output.	1	Opening torque request	1 = Opening torque requested from drive logic.	2	Hold stopped request	1 = Hold requested from drive logic	3	Ramp to stopped	1 = Ramping down to zero speed requested from drive logic	4	Enabled	1 = Brake control is enabled	5	Closed	1 = Brake control logic in <a href="#">BRAKE CLOSED</a> state	6	Opening	1 = Brake control logic in <a href="#">BRAKE OPENING</a> state	7	Open	1 = Brake control logic in <a href="#">BRAKE OPEN</a> state	8	Closing	1 = Brake control logic in <a href="#">BRAKE CLOSING</a> state	9...15	Reserved	
Bit	Name	Information																																		
0	Open command	Close/open command to brake actuator (0 = close, 1 = open). Connect this bit to desired output.																																		
1	Opening torque request	1 = Opening torque requested from drive logic.																																		
2	Hold stopped request	1 = Hold requested from drive logic																																		
3	Ramp to stopped	1 = Ramping down to zero speed requested from drive logic																																		
4	Enabled	1 = Brake control is enabled																																		
5	Closed	1 = Brake control logic in <a href="#">BRAKE CLOSED</a> state																																		
6	Opening	1 = Brake control logic in <a href="#">BRAKE OPENING</a> state																																		
7	Open	1 = Brake control logic in <a href="#">BRAKE OPEN</a> state																																		
8	Closing	1 = Brake control logic in <a href="#">BRAKE CLOSING</a> state																																		
9...15	Reserved																																			
	0000h...FFFFh	Mechanical brake control status word.	1 = 1																																	

## 374 Parameters

No.	Name/Value	Description	Def/FbEq16
44.06	<i>Brake control enable</i>	Activates/deactivates (or selects a source that activates/deactivates) the mechanical brake control logic. 0 = Brake control inactive 1 = Brake control active	<i>Not selected</i>
	Not selected	0.	0
	Selected	1.	1
	DI1	Digital input DI1 ( <i>10.02 DI delayed status</i> , bit 0).	2
	DI2	Digital input DI2 ( <i>10.02 DI delayed status</i> , bit 1).	3
	DI3	Digital input DI3 ( <i>10.02 DI delayed status</i> , bit 2).	4
	DI4	Digital input DI4 ( <i>10.02 DI delayed status</i> , bit 3).	5
	DI5	Digital input DI5 ( <i>10.02 DI delayed status</i> , bit 4).	6
	DI6	Digital input DI6 ( <i>10.02 DI delayed status</i> , bit 5).	7
	Reserved		8...17
	Timed function 1	Bit 0 of <i>34.01 Timed functions status</i> (see page 327).	18
	Timed function 2	Bit 1 of <i>34.01 Timed functions status</i> (see page 327).	19
	Timed function 3	Bit 2 of <i>34.01 Timed functions status</i> (see page 327).	20
	Reserved		21...23
	Supervision 1	Bit 0 of <i>32.01 Supervision status</i> (see page 319).	24
	Supervision 2	Bit 1 of <i>32.01 Supervision status</i> (see page 319).	25
	Supervision 3	Bit 2 of <i>32.01 Supervision status</i> (see page 319).	26
	<i>Other [bit]</i>	Source selection (see <i>Terms and abbreviations</i> on page 196).	-
44.08	<i>Brake open delay</i>	Defines the brake open delay, ie. the delay between the internal open brake command and the release of motor speed control. The delay timer starts when the drive has magnetized the motor. Simultaneously with the timer start, the brake control logic energizes the brake control output and the brake starts to open. Set this parameter to the value of mechanical opening delay specified by the brake manufacturer.	0.00 s
	0.00...5.00 s	Brake open delay.	100 = 1 s
44.13	<i>Brake close delay</i>	Specifies a delay between a close command (that is, when the brake control output is de-energized) and when the drive stops modulating. This is to keep the motor live and under control until the brake actually closes. Set this parameter equal to the value specified by the brake manufacturer as the mechanical wake-up time of the brake.	0.00 s
	0.00...60.00 s	Brake close delay.	100 = 1 s
44.14	<i>Brake close level</i>	Defines the brake close speed as an absolute value. After motor speed has decelerated to this level, a close command is given.	100.00 rpm
	0.00...1000.00 rpm	Brake close speed.	See par. <i>46.01</i>

No.	Name/Value	Description	Def/FbEq16
<b>45 Energy efficiency</b>		Settings for the energy saving calculators as well as peak and energy loggers. See also section <i>Energy saving calculators</i> (page 186).	
45.01	<i>Saved GW hours</i>	Energy saved in GWh compared to direct-on-line motor connection. This parameter is incremented when <b>45.02 Saved MW hours</b> rolls over. This parameter is read-only (see parameter <b>45.21 Energy calculations reset</b> ).	-
	0...65535 GWh	Energy savings in GWh.	1 = 1 GWh
45.02	<i>Saved MW hours</i>	Energy saved in MWh compared to direct-on-line motor connection. This parameter is incremented when <b>45.03 Saved kW hours</b> rolls over. When this parameter rolls over, parameter <b>45.01 Saved GW hours</b> is incremented. This parameter is read-only (see parameter <b>45.21 Energy calculations reset</b> ).	-
	0...999 MWh	Energy savings in MWh.	1 = 1 MWh
45.03	<i>Saved kW hours</i>	Energy saved in kWh compared to direct-on-line motor connection. If the internal brake chopper of the drive is enabled, all energy fed by the motor to the drive is assumed to be converted into heat, but the calculation still records savings made by controlling the speed. If the chopper is disabled, then regenerated energy from the motor is also recorded here. When this parameter rolls over, parameter <b>45.02 Saved MW hours</b> is incremented. This parameter is read-only (see parameter <b>45.21 Energy calculations reset</b> ).	-
	0.0...999.9 kWh	Energy savings in kWh.	10 = 1 kWh
45.04	<i>Saved energy</i>	Energy saved in kWh compared to direct-on-line motor connection. If the internal brake chopper of the drive is enabled, all energy fed by the motor to the drive is assumed to be converted into heat. This parameter is read-only (see parameter <b>45.21 Energy calculations reset</b> ).	-
	0.0...214748352.0 kWh	Energy savings in kWh.	1 = 1 kWh
45.05	<i>Saved money x1000</i>	Monetary savings in thousands compared to direct-on-line motor connection. This parameter is incremented when <b>45.06 Saved money</b> rolls over. You can define the currency during the first start up or from primary settings ( <b>Main menu - Primary settings - Clock, region display - Units - Currency</b> ). This parameter is read-only (see parameter <b>45.21 Energy calculations reset</b> ).	-
	0...4294967295 thousands	Monetary savings in thousands of units.	1 = 1 unit

## 376 Parameters

No.	Name/Value	Description	Def/FbEq16
45.06	<i>Saved money</i>	<p>Monetary savings compared to direct-on-line motor connection. This value is a calculated by multiplying the saved energy in kWh by the currently active energy tariff (<a href="#">45.14 Tariff selection</a>).</p> <p>When this parameter rolls over, parameter <a href="#">45.05 Saved money x1000</a> is incremented.</p> <p>You can define the currency during the first start up or from primary settings (<b>Main menu - Primary settings - Clock, region display - Units - Currency</b>).</p> <p>This parameter is read-only (see parameter <a href="#">45.21 Energy calculations reset</a>).</p>	-
	0.00...999.99 units	Monetary savings.	1 = 1 unit
45.07	<i>Saved amount</i>	<p>Monetary savings compared to direct-on-line motor connection. This value is a calculated by multiplying the saved energy in kWh by the currently active energy tariff (<a href="#">45.14 Tariff selection</a>).</p> <p>You can define the currency during the first start up or from primary settings (<b>Main menu - Primary settings - Clock, region display - Units - Currency</b>).</p> <p>This parameter is read-only (see parameter <a href="#">45.21 Energy calculations reset</a>).</p>	-
	0.00... 21474830.08 units	Monetary savings.	1 = 1 unit
45.08	<i>CO2 reduction in kilotons</i>	<p>Reduction in CO<sub>2</sub> emissions in metric kilotons compared to direct-on-line motor connection. This value is incremented when parameter <a href="#">45.09 CO2 reduction in tons</a> rolls over.</p> <p>This parameter is read-only (see parameter <a href="#">45.21 Energy calculations reset</a>).</p>	-
	0...65535 metric kilotons	Reduction in CO <sub>2</sub> emissions in metric kilotons.	1 = 1 metric kiloton
45.09	<i>CO2 reduction in tons</i>	<p>Reduction in CO<sub>2</sub> emissions in metric tons compared to direct-on-line motor connection. This value is calculated by multiplying the saved energy in MWh by the value of parameter <a href="#">45.18 CO2 conversion factor</a> (by default, 0.5 metric tons/MWh).</p> <p>When this parameter rolls over, parameter <a href="#">45.08 CO2 reduction in kilotons</a> is incremented.</p> <p>This parameter is read-only (see parameter <a href="#">45.21 Energy calculations reset</a>).</p>	-
	0.0...999.9 metric tons	Reduction in CO <sub>2</sub> emissions in metric tons.	1 = 1 metric ton
45.10	<i>Total saved CO2</i>	<p>Reduction in CO<sub>2</sub> emissions in metric tons compared to direct-on-line motor connection. This value is calculated by multiplying the saved energy in MWh by the value of parameter <a href="#">45.18 CO2 conversion factor</a> (by default, 0.5 metric tons/MWh).</p> <p>This parameter is read-only (see parameter <a href="#">45.21 Energy calculations reset</a>).</p>	-
	0.0...214748300.8 metric tons	Reduction in CO <sub>2</sub> emissions in metric tons.	1 = 1 metric ton



No.	Name/Value	Description	Def/FbEq16
45.11	<i>Energy optimizer</i>	Enables/disables the energy optimization function. The function optimizes the motor flux so that total energy consumption and motor noise level are reduced when the drive operates below the nominal load. The total efficiency (motor and drive) can be improved by 1...20% depending on load torque and speed. <b>Note:</b> With a permanent magnet motor and a synchronous reluctance motor, energy optimization is always enabled regardless of this parameter. <b>Note:</b> Do not use energy optimizer in multimotor systems.	<i>Disable</i>
	Disable	Energy optimization disabled.	0
	Enable	Energy optimization enabled.	1
45.12	<i>Energy tariff 1</i>	Defines energy tariff 1 (price of energy per kWh). Depending on the setting of parameter <i>45.14 Tariff selection</i> , either this value or <i>45.13 Energy tariff 2</i> is used for reference when monetary savings are calculated. You can define the currency during the first start up or from primary settings ( <b>Main menu - Primary settings - Clock, region display - Units - Currency</b> ). <b>Note:</b> Tariffs are read only at the instant of selection, and are not applied retroactively.	0.100 units
	0.000... 4294966.296 units	Energy tariff 1.	-
45.13	<i>Energy tariff 2</i>	Defines energy tariff 2 (price of energy per kWh). See parameter <i>45.12 Energy tariff 1</i> .	0.200 units
	0.000... 4294966.296 units	Energy tariff 2.	-
45.14	<i>Tariff selection</i>	Selects (or defines a source that selects) which pre-defined energy tariff is used. 0 = <i>45.12 Energy tariff 1</i> 1 = <i>45.13 Energy tariff 2</i>	<i>Energy tariff 1</i>
	Energy tariff 1	0.	0
	Energy tariff 2	1.	1
	DI1	Digital input DI1 ( <i>10.02 DI delayed status</i> , bit 0).	2
	DI2	Digital input DI2 ( <i>10.02 DI delayed status</i> , bit 1).	3
	DI3	Digital input DI3 ( <i>10.02 DI delayed status</i> , bit 2).	4
	DI4	Digital input DI4 ( <i>10.02 DI delayed status</i> , bit 3).	5
	DI5	Digital input DI5 ( <i>10.02 DI delayed status</i> , bit 4).	6
	DI6	Digital input DI6 ( <i>10.02 DI delayed status</i> , bit 5).	7
45.18	<i>CO2 conversion factor</i>	Defines a factor for conversion of saved energy into CO <sub>2</sub> emissions (kg/kWh or tn/MWh). <b>Example:</b> <i>45.10 Total saved CO2 = 45.02 Saved MW hours × 45.18 CO2 conversion factor</i> (tn/MWh).	0.500 tn/MWh (metric ton)
	0.000...65.535 tn/MWh	Factor for conversion of saved energy into CO <sub>2</sub> emissions.	1 = 1 tn/MWh

## 378 Parameters

No.	Name/Value	Description	Def/FbEq16
45.19	<i>Comparison power</i>	Actual power that the motor absorbs when connected direct-on-line and operating the application. The value is used for reference when energy savings are calculated. <b>Note:</b> The accuracy of the energy savings calculation is directly dependent on the accuracy of this value. If nothing is entered here, then the nominal motor power is used by the calculation, but that may inflate the energy savings reported as many motors do not absorb nameplate power.	0.00 kW
	0.00...10000000.00 kW	Motor power.	1 = 1 kW
45.21	<i>Energy calculations reset</i>	Resets the savings counter parameters <i>45.01...45.10</i> .	<i>Done</i>
	Done	Reset not requested (normal operation), or reset complete.	0
	Reset	Reset the savings counter parameters. The value reverts automatically to <i>Done</i> .	1
45.24	<i>Hourly peak power value</i>	Value of the peak power during the last hour, that is, the most recent 60 minutes after the drive has been powered up. The parameter is updated once every 10 minutes unless the hourly peak is found in the most recent 10 minutes. In that case, the values is shown immediately.	0.00 kW
	-3000.00 ... 3000.00 kW	Peak power value.	10 = 1 kW
45.25	<i>Hourly peak power time</i>	Time of the peak power value during the last hour.	00:00:00
		Time.	N/A
45.26	<i>Hourly total energy (resettable)</i>	Total energy consumption during the last hour, that is, the most recent 60 minutes. You can reset the value by setting it to zero.	0.00 kWh
	-3000.00 ... 3000.00 kWh	Total energy.	10 = 1 kWh
45.27	<i>Daily peak power value (resettable)</i>	Value of the peak power since midnight of the present day. You can reset the value by setting it to zero.	0.00 kW
	-3000.00 ... 3000.00 kW	Peak power value.	10 = 1 kW
45.28	<i>Daily peak power time</i>	Time of the peak power since midnight of the present day.	00:00:00
		Time.	N/A
45.29	<i>Daily total energy (resettable)</i>	Total energy consumption since midnight of the present day. You can reset the value by setting it to zero.	0.00 kWh
	-30000.00 ... 30000.00 kWh	Total energy.	1 = 1 kWh
45.30	<i>Last day total energy</i>	Total energy consumption during the previous day, that is, between midnight of the previous day and midnight of the present day	0.00 kWh
	-30000.00 ... 30000.00 kWh	Total energy.	1 = 1 kWh
45.31	<i>Monthly peak power value (resettable)</i>	Value of the peak power during the present month, that is, since midnight of the first day of the present month. You can reset the value by setting it to zero.	0.00 kW
	-3000.00 ... 3000.00 kW	Peak power value.	10 = 1 kW

No.	Name/Value	Description	Def/FbEq16
45.32	<i>Monthly peak power date</i>	Date of the peak power during the present month.	1.1.1980
		Date.	N/A
45.33	<i>Monthly peak power time</i>	Time of the peak power during the present month.	00:00:00
		Time.	N/A
45.34	<i>Monthly total energy (resettable)</i>	Total energy consumption from the beginning of the present month. You can reset the value by setting it to zero.	0.00 kWh
	-1000000.00 ... 1000000.00 kWh	Total energy.	0.01 = 1 kWh
45.35	<i>Last month total energy</i>	Total energy consumption during the previous month, that is, between midnight of the first day or the previous month and midnight of the first day of the present month.	0.00 kWh
	-1000000.00 ... 1000000.00 kWh		0.01 = 1 kWh
45.36	<i>Lifetime peak power value</i>	Value of the peak power over the drive lifetime.	0.00 kW
	-3000.00 ... 3000.00 kW	Peak power value.	10 = 1 kW
45.37	<i>Lifetime peak power date</i>	Date of the peak power over the drive lifetime.	1.1.1980
		Date.	N/A
45.38	<i>Lifetime peak power time</i>	Time of the peak power over the drive lifetime.	00:00:00
		Time.	N/A
<b>46 Monitoring/scaling settings</b>		Speed supervision settings; actual signal filtering; general scaling settings.	
46.01	<i>Speed scaling</i>	Defines the maximum speed value used to define the acceleration ramp rate and the initial speed value used to define the deceleration ramp rate (see parameter group <a href="#">23 Speed reference ramp</a> ). The speed acceleration and deceleration ramp times are therefore related to this value ( <b>not</b> to parameter <a href="#">30.12 Maximum speed</a> ). Also defines the 16-bit scaling of speed-related parameters. The value of this parameter corresponds to 20000 in, for example, fieldbus communication.	1500.00 rpm; 1800.00 rpm ( <a href="#">95.20 b0</a> )
	0.10...30000.00 rpm	Acceleration/deceleration terminal/initial speed.	1 = 1 rpm
46.02	<i>Frequency scaling</i>	Defines the maximum frequency value used to define the acceleration ramp rate and the initial frequency value used to define deceleration ramp rate (see parameter group <a href="#">28 Frequency reference chain</a> ). The frequency acceleration and deceleration ramp times are therefore related to this value ( <b>not</b> to parameter <a href="#">30.14 Maximum frequency</a> ). Also defines the 16-bit scaling of frequency-related parameters. The value of this parameter corresponds to 20000 in, for example, fieldbus communication.	50.00 Hz; 60.00 Hz ( <a href="#">95.20 b0</a> )
	0.10...1000.00 Hz	Acceleration/deceleration terminal/initial frequency.	10 = 1 Hz

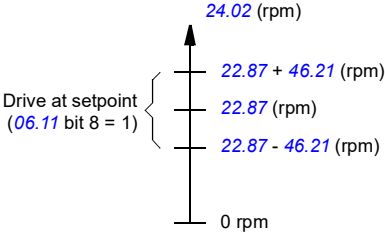
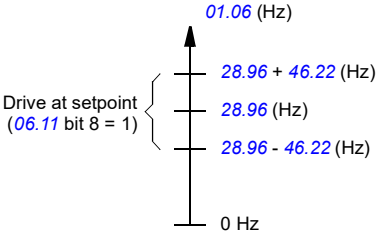

## 380 Parameters

No.	Name/Value	Description	Def/FbEq16
46.03	<i>Torque scaling</i>	Defines the 16-bit scaling of torque parameters. The value of this parameter (in percent of nominal motor torque) corresponds to 10000 in, for example, fieldbus communication.	100.0%
	0.1...1000.0%	Torque corresponding to 10000 on fieldbus.	10 = 1%
46.04	<i>Power scaling</i>	Defines the 16-bit scaling of power parameters. The value of this parameter corresponds to 10000 in the fieldbus communication. The unit is selected by parameter <a href="#">96.16 Unit selection</a> . For 32-bit scaling see <a href="#">46.43 Power decimals</a> .	1000.00
	0.10 ... 30000.00 kW or 0.10 ... 40214.48 hp	Power corresponding to 10000 on fieldbus.	1 = 1
46.05	<i>Current scaling</i>	Defines the 16-bit scaling of current parameters. The value of this parameter corresponds to 10000 in fieldbus communication. For 32-bit scaling see <a href="#">46.44 Current decimals</a> .	10000 A
	0...30000 A	Current corresponding to 10000 on fieldbus.	1 = 1 A
46.06	<i>Speed ref zero scaling</i>	Defines a speed corresponding to a zero reference received from fieldbus (either the embedded fieldbus interface, or interface FBA A). For example, with a setting of 500, the fieldbus reference range of 0...20000 would correspond to a speed of 500... <a href="#">[46.01]</a> rpm. <b>Note:</b> This parameter is effective only with the ABB Drives communication profile.	0.00 rpm
	0.00 ... 30000.00 rpm	Speed corresponding to minimum fieldbus reference.	1 = 1 rpm
46.07	<i>Frequency ref zero scaling</i>	Defines a frequency corresponding to a zero reference received from fieldbus (either the embedded fieldbus interface, or interface FBA). For example, with a setting of 30, the fieldbus reference range of 0...20000 would correspond to a speed of 30... <a href="#">[46.02]</a> Hz. <b>Note:</b> This parameter is effective only with the ABB Drives communication profile.	0.00 Hz
	0.00 ... 1000.00 Hz	Frequency corresponding to minimum fieldbus reference.	10 = 1 Hz
46.11	<i>Filter time motor speed</i>	Defines a filter time for signals <a href="#">01.01 Motor speed used</a> and <a href="#">01.02 Motor speed estimated</a> .	500 ms
	2...20000 ms	Motor speed signal filter time.	1 = 1 ms
46.12	<i>Filter time output frequency</i>	Defines a filter time for signal <a href="#">01.06 Output frequency</a> .	500 ms
	2...20000 ms	Output frequency signal filter time.	1 = 1 ms
46.13	<i>Filter time motor torque</i>	Defines a filter time for signal <a href="#">01.10 Motor torque</a> .	100 ms
	2...20000 ms	Motor torque signal filter time.	1 = 1 ms
46.14	<i>Filter time power</i>	Defines a filter time for signal <a href="#">01.14 Output power</a> .	100 ms
	2...20000 ms	Output power signal filter time.	1 = 1 ms

No.	Name/Value	Description	Def/FbEq16
46.21	<i>At speed hysteresis</i>	<p>Defines the "at setpoint" limits for speed control of the drive. When the difference between reference (<a href="#">22.87 Speed reference act 7</a>) and the speed (<a href="#">24.02 Used speed feedback</a>) is smaller than <a href="#">46.21 At speed hysteresis</a>, the drive is considered to be "at setpoint". This is indicated by bit 8 of <a href="#">06.11 Main status word</a>.</p> 	50.00 rpm
	0.00...30000.00 rpm	Limit for "at setpoint" indication in speed control.	See par. <a href="#">46.01</a>
46.22	<i>At frequency hysteresis</i>	<p>Defines the "at setpoint" limits for frequency control of the drive. When the absolute difference between reference (<a href="#">28.96 Frequency ref ramp input</a>) and actual frequency (<a href="#">01.06 Output frequency</a>) is smaller than <a href="#">46.22 At frequency hysteresis</a>, the drive is considered to be "at setpoint". This is indicated by bit 8 of <a href="#">06.11 Main status word</a>.</p> 	2.00 Hz
	0.00...1000.00 Hz	Limit for "at setpoint" indication in frequency control.	See par. <a href="#">46.02</a>

No.	Name/Value	Description	Def/FbEq16
46.23	<i>At torque hysteresis</i>	<p>Defines the “at setpoint” limits for torque control of the drive. When the absolute difference between reference (<a href="#">26.73 Torque reference act 4</a>) and actual torque (<a href="#">01.10 Motor torque</a>) is smaller than <a href="#">46.23 At torque hysteresis</a>, the drive is considered to be “at setpoint”. This is indicated by bit 8 of <a href="#">06.11 Main status word</a>.</p>	5.0%
	0.0...300.0%	Limit for “at setpoint” indication in torque control.	See par. <a href="#">46.03</a>
46.31	<i>Above speed limit</i>	Defines the trigger level for “above limit” indication in speed control. When actual speed exceeds the limit, bit 10 of <a href="#">06.17 Drive status word 2</a> and bit 10 of <a href="#">06.11 Main status word</a> are set.	1500.00 rpm; 1800.00 rpm ( <a href="#">95.20 b0</a> )
	0.00...30000.00 rpm	“Above limit” indication trigger level for speed control.	See par. <a href="#">46.01</a>
46.32	<i>Above frequency limit</i>	Defines the trigger level for “above limit” indication in frequency control. When actual frequency exceeds the limit, bit 10 of <a href="#">06.17 Drive status word 2</a> and bit 10 of <a href="#">06.11 Main status word</a> are set.	50.00 Hz; 60.00 Hz ( <a href="#">95.20 b0</a> )
	0.00...1000.00 Hz	“Above limit” indication trigger level for frequency control.	See par. <a href="#">46.02</a>
46.33	<i>Above torque limit</i>	Defines the trigger level for “above limit” indication in torque control. When actual torque exceeds the limit, bit 10 of <a href="#">06.17 Drive status word 2</a> and bit 10 of <a href="#">06.11 Main status word</a> are set.	300.0%
	0.0...1600.0%	“Above limit” indication trigger level for torque control.	See par. <a href="#">46.03</a>
46.41	<i>kWh pulse scaling</i>	Defines the trigger level for the “kWh pulse” on for 50 ms. The output of the pulse is bit 9 of <a href="#">05.22 Diagnostic word 3</a> .	1.000 kWh
	0.001... 1000.000 kWh	“kWh pulse” on trigger level.	1 = 1 kWh
46.43	<i>Power decimals</i>	Defines the number of display decimals places and 32-bit scaling of power-related parameters. The value of this parameter corresponds to the number of decimals assumed in the 32-bit integer fieldbus communication (for 16-bit scaling see <a href="#">46.04 Power scaling</a> ).	2
	0...3	Number of decimals.	1 = 1
46.44	<i>Current decimals</i>	Defines the number of display decimals places and 32-bit scaling of current-related parameters. The value of this parameter corresponds to the number of decimals assumed in the 32-bit integer fieldbus communication (for 16-bit scaling see <a href="#">46.05 Current scaling</a> ).	1
	0...3	Number of decimals.	1 = 1



No.	Name/Value	Description	Def/FbEq16
<b>47 Data storage</b>		Data storage parameters that can be written to and read from using other parameters' source and target settings. Note that there are different storage parameters for different data types. See also section <a href="#">Data storage parameters</a> (page 191).	
47.01	<a href="#">Data storage 1 real32</a>	Data storage parameter 1.	0.000
	-2147483.000... 2147483.000	32-bit data.	-
47.02	<a href="#">Data storage 2 real32</a>	Data storage parameter 2.	0.000
	-2147483.000... 2147483.000	32-bit data.	-
47.03	<a href="#">Data storage 3 real32</a>	Data storage parameter 3.	0.000
	-2147483.000... 2147483.000	32-bit data.	-
47.04	<a href="#">Data storage 4 real32</a>	Data storage parameter 4.	0.000
	-2147483.000... 2147483.000	32-bit data.	-
47.11	<a href="#">Data storage 1 int32</a>	Data storage parameter 9.	0
	-2147483648... 2147483647	32-bit data.	-
47.12	<a href="#">Data storage 2 int32</a>	Data storage parameter 10.	0
	-2147483648... 2147483647	32-bit data.	-
47.13	<a href="#">Data storage 3 int32</a>	Data storage parameter 11.	0
	-2147483648... 2147483647	32-bit data.	-
47.14	<a href="#">Data storage 4 int32</a>	Data storage parameter 12.	0
	-2147483648... 2147483647	32-bit data.	-
47.21	<a href="#">Data storage 1 int16</a>	Data storage parameter 17.	0
	-32768...32767	16-bit data.	1 = 1
47.22	<a href="#">Data storage 2 int16</a>	Data storage parameter 18.	0
	-32768...32767	16-bit data.	1 = 1
47.23	<a href="#">Data storage 3 int16</a>	Data storage parameter 19.	0
	-32768...32767	16-bit data.	1 = 1

No.	Name/Value	Description	Def/FbEq16
47.24	<i>Data storage 4 int16</i>	Data storage parameter 20.	0
	-32768...32767	16-bit data.	1 = 1
<b>49 Panel port communication</b>		Communication settings for the control panel port on the drive.	
49.01	<i>Node ID number</i>	Defines the node ID of the drive. All devices connected to the network must have a unique node ID. <b>Note:</b> For networked drives, it is advisable to reserve ID 1 for spare/replacement drives.	1
	1...32	Node ID.	1 = 1
49.03	<i>Baud rate</i>	Defines the transfer rate of the link.	<i>115.2 kbps</i>
	38.4 kbps	38.4 kbit/s.	1
	57.6 kbps	57.6 kbit/s.	2
	86.4 kbps	86.4 kbit/s.	3
	115.2 kbps	115.2 kbit/s.	4
	230.4 kbps	230.4 kbit/s.	5
49.04	<i>Communication loss time</i>	Sets a timeout for control panel (or PC tool) communication. If a communication break lasts longer than the timeout, the action specified by parameter <i>49.05 Communication loss action</i> is taken.	10.0 s
	0.3...3000.0 s	Control panel/PC tool communication timeout.	10 = 1 s
49.05	<i>Communication loss action</i>	Selects how the drive reacts to a control panel (or PC tool) communication break.	<i>Fault</i>
	No action	No action taken.	0
	Fault	Drive trips on <i>7081 Control panel loss</i> .	1
	Last speed	Drive generates an <i>A7EE Panel loss</i> warning and freezes the speed to the level the drive was operating at. The speed is determined on the basis of actual speed using 850 ms low-pass filtering.  <b>WARNING!</b> Make sure that it is safe to continue operation in case of a communication break.	2
	Speed ref safe	Drive generates an <i>A7EE Panel loss</i> warning and sets the speed to the speed defined by parameter <i>22.41 Speed ref safe</i> (or <i>28.41 Frequency ref safe</i> when frequency reference is being used).  <b>WARNING!</b> Make sure that it is safe to continue operation in case of a communication break.	3
49.06	<i>Refresh settings</i>	Applies the settings of parameters <i>49.01...49.05</i> . <b>Note:</b> Refreshing may cause a communication break, so reconnecting the drive may be required.	<i>Done</i>
	Done	Refresh done or not requested.	0
	Configure	Refresh parameters <i>49.01...49.05</i> . The value reverts automatically to <i>Done</i> .	1
49.19	<i>Basic panel home view 1</i>	Selects the parameter that is shown in Home view 1 of the Basic control panel (ACS-BP-S) when the active external control location is EXT1. Home view 1 is toggled automatically between Home view 4 (parameter <i>49.219</i> ) according to the active external control location EXT1 or EXT2, respectively.	<i>Auto</i>



No.	Name/Value	Description	Def/FbEq16
	Auto	Shows the factory default parameters.	0
	Motor speed used	<a href="#">01.01 Motor speed used</a>	1
	Output frequency	<a href="#">01.06 Output frequency</a>	3
	Motor current	<a href="#">01.07 Motor current</a>	4
	Motor current % of motor nominal	<a href="#">01.08 Motor current % of motor nom</a>	5
	Motor torque	<a href="#">01.10 Motor torque</a>	6
	DC voltage	<a href="#">01.11 DC voltage</a>	7
	Output power	<a href="#">01.14 Output power</a>	8
	Speed ref ramp in	<a href="#">23.01 Speed ref ramp input</a>	10
	Speed ref ramp out	<a href="#">23.02 Speed ref ramp output</a>	11
	Speed ref used	<a href="#">24.01 Used speed reference</a>	12
	Freq ref used	<a href="#">28.02 Frequency ref ramp output</a>	14
	Process PID out	<a href="#">40.01 Process PID output actual</a>	16
	Temp sensor 1 excitation	Excitation current to the temperature sensor 1, see parameter <a href="#">35.11 Temperature 1 source</a> . See also section <a href="#">Motor thermal protection</a> (page 177).	20
	Temp sensor 2 excitation	Excitation current to the temperature sensor 2, see parameter <a href="#">35.21 Temperature 2 source</a> . See also section <a href="#">Motor thermal protection</a> (page 177).	21
	Abs motor speed used	<a href="#">01.61 Abs motor speed used</a>	26
	Abs motor speed %	<a href="#">01.62 Abs motor speed %</a>	27
	Abs output frequency	<a href="#">01.63 Abs output frequency</a>	28
	Abs motor torque	<a href="#">01.64 Abs motor torque</a>	30
	Abs output power	<a href="#">01.65 Abs output power</a>	31
	Abs motor shaft power	<a href="#">01.68 Abs motor shaft power</a>	32
	External PID1 out	<a href="#">71.01 External PID act value</a>	33
	AO1 data storage	<a href="#">13.91 AO1 data storage</a>	37
	AO2 data storage	<a href="#">13.92 AO2 data storage</a>	38
	<a href="#">Other [bit]</a>	Source selection (see <a href="#">Terms and abbreviations</a> on page 196).	-
<a href="#">49.20</a>	<a href="#">Basic panel home view 2</a>	Selects the parameters that are shown in Home view 2 of the integrated or Basic control panel (ACS-BP-S) when the active external control location is EXT1. Home view 2 is toggled automatically between Home view 5 (parameter <a href="#">49.220</a> ) according to the active external control location EXT1 or EXT2, respectively. For the selections, see parameter <a href="#">49.19 Basic panel home view 1</a> .	<a href="#">Auto</a>

No.	Name/Value	Description	Def/FbEq16
49.21	<i>Basic panel home view 3</i>	Selects the parameters that are shown in Home view 3 of the integrated or Basic control panel (ACS-BP-S) when the active external control location is EXT1. Home view 3 is toggled automatically between Home view 6 (parameter 49.221) according to the active external control location EXT1 or EXT2, respectively. For the selections, see parameter 49.19 <i>Basic panel home view 1</i> .	<i>Auto</i>
49.219	<i>Basic panel home view 4</i>	Selects the parameters that are shown in Home view 4 of the integrated or Basic control panel (ACS-BP-S) when the active external control location is EXT2. Home view 1 (parameter 49.19) is toggled automatically between Home view 4 according to the active external control location EXT1 or EXT2, respectively. For the selections, see parameter 49.19 <i>Basic panel home view 1</i> .	<i>Auto</i>
49.220	<i>Basic panel home view 5</i>	Selects the parameters that are shown in Home view 5 of the integrated or Basic control panel (ACS-BP-S) when the active external control location is EXT2. Home view 2 (parameter 49.20) is toggled automatically between Home view 5 according to the active external control location EXT1 or EXT2, respectively. For the selections, see parameter 49.19 <i>Basic panel home view 1</i> .	<i>Auto</i>
49.221	<i>Basic panel home view 6</i>	Selects the parameters that are shown in Home view 6 of the integrated or Basic control panel (ACS-BP-S) when the active external control location is EXT2. Home view 3 (parameter 49.21) is toggled automatically between Home view 6 according to the active external control location EXT1 or EXT2, respectively. For the selections, see parameter 49.19 <i>Basic panel home view 1</i> .	<i>Auto</i>
<b>50 Fieldbus adapter (FBA)</b>		Fieldbus communication configuration. See also chapter <i>Fieldbus control through a fieldbus adapter</i> (page 535).	
50.01	<i>FBA A enable</i>	Enables/disables communication between the drive and fieldbus adapter A, and specifies the slot the adapter is installed into.	<i>Enable</i>
	Disable	Communication between drive and fieldbus adapter A disabled.	0
	Enable	Communication between drive and fieldbus adapter A enabled. The adapter is in slot 1.	1
50.02	<i>FBA A comm loss func</i>	Selects how the drive reacts upon a fieldbus communication break. The time delay is defined by parameter 50.03 <i>FBA A comm loss t out</i> .	<i>No action</i>
	No action	No action taken.	0
	Fault	Drive trips on <i>7510 FBA A communication</i> . This only occurs if control is expected from the fieldbus (FBA A selected as source of start/stop/reference in the currently active control location).	1

No.	Name/Value	Description	Def/FbEq16								
	Last speed	Drive generates a warning ( <i>A7C1 FBA A communication</i> ) and freezes the speed to the level the drive was operating at. This only occurs if control is expected from the fieldbus. The speed is determined on the basis of actual speed using 850 ms low-pass filtering.  <b>WARNING!</b> Make sure that it is safe to continue operation in case of a communication break.	2								
	Speed ref safe	Drive generates a warning ( <i>A7C1 FBA A communication</i> ) and sets the speed to the value defined by parameter <i>22.41 Speed ref safe</i> (in speed control) or <i>28.41 Frequency ref safe</i> (in frequency control). This only occurs if control is expected from the fieldbus.  <b>WARNING!</b> Make sure that it is safe to continue operation in case of a communication break.	3								
	Fault always	Drive trips on <i>7510 FBA A communication</i> . This occurs even though no control is expected from the fieldbus.	4								
	Warning	Drive generates an <i>A7C1 FBA A communication</i> warning. This only occurs if control is expected from the fieldbus.  <b>WARNING!</b> Make sure that it is safe to continue operation in case of a communication break.	5								
<i>50.03</i>	<i>FBA A comm loss t out</i>	Defines the time delay before the action defined by parameter <i>50.02 FBA A comm loss func</i> is taken. Time count starts when the communication link fails to update the message. <b>Note:</b> There is a 60-second boot-up delay immediately after power-up. During the delay, the communication break monitoring is disabled (but communication itself can be active).	0.3 s								
	0.3...6553.5 s	Time delay.	1 = 1 s								
<i>50.04</i>	<i>FBA A ref1 type</i>	Selects the type and scaling of reference 1 received from fieldbus adapter A. The scaling of the reference is defined by parameters <i>46.01...46.04</i> , depending on which reference type is selected by this parameter.	<i>Speed or frequency</i>								
	Speed or frequency	Type and scaling is chosen automatically according to the currently active operation mode as follows: <table border="1" data-bbox="400 1013 893 1145"> <thead> <tr> <th>Operation mode (see par. <i>19.01</i>)</th> <th>Reference 1 type</th> </tr> </thead> <tbody> <tr> <td>Speed control</td> <td><i>Speed</i></td> </tr> <tr> <td>Torque control</td> <td><i>Speed</i></td> </tr> <tr> <td>Frequency control</td> <td><i>Frequency</i></td> </tr> </tbody> </table>	Operation mode (see par. <i>19.01</i> )	Reference 1 type	Speed control	<i>Speed</i>	Torque control	<i>Speed</i>	Frequency control	<i>Frequency</i>	0
Operation mode (see par. <i>19.01</i> )	Reference 1 type										
Speed control	<i>Speed</i>										
Torque control	<i>Speed</i>										
Frequency control	<i>Frequency</i>										
	Transparent	No scaling is applied (the 16-bit scaling is 1 = 1 unit).	1								
	General	Generic reference with a 16-bit scaling of 100 = 1 (ie. integer and two decimals).	2								
	Torque	The scaling is defined by parameter <i>46.03 Torque scaling</i> .	3								
	Speed	The scaling is defined by parameter <i>46.01 Speed scaling</i> .	4								
	Frequency	The scaling is defined by parameter <i>46.02 Frequency scaling</i> .	5								

No.	Name/Value	Description	Def/FbEq16								
50.05	<i>FBA A ref2 type</i>	Selects the type and scaling of reference 2 received from fieldbus adapter A. The scaling of the reference is defined by parameters <i>46.01...46.04</i> , depending on which reference type is selected by this parameter.	<i>Speed or frequency</i>								
	Speed or frequency	Type and scaling is chosen automatically according to the currently active operation mode as follows: <table border="1" data-bbox="344 331 840 462"> <thead> <tr> <th>Operation mode (see par. 19.01)</th> <th>Reference 2 type</th> </tr> </thead> <tbody> <tr> <td>Speed control</td> <td><i>Torque</i></td> </tr> <tr> <td>Torque control</td> <td><i>Torque</i></td> </tr> <tr> <td>Frequency control</td> <td><i>Torque</i></td> </tr> </tbody> </table>	Operation mode (see par. 19.01)	Reference 2 type	Speed control	<i>Torque</i>	Torque control	<i>Torque</i>	Frequency control	<i>Torque</i>	0
Operation mode (see par. 19.01)	Reference 2 type										
Speed control	<i>Torque</i>										
Torque control	<i>Torque</i>										
Frequency control	<i>Torque</i>										
	Transparent	No scaling is applied (the 16-bit scaling is 1 = 1 unit).	1								
	General	Generic reference with a 16-bit scaling of 100 = 1 (ie. integer and two decimals).	2								
	Torque	The scaling is defined by parameter <i>46.03 Torque scaling</i> .	3								
	Speed	The scaling is defined by parameter <i>46.01 Speed scaling</i> .	4								
	Frequency	The scaling is defined by parameter <i>46.02 Frequency scaling</i> .	5								
50.06	<i>FBA A SW sel</i>	Selects the source of the Status word to be sent to the fieldbus network through fieldbus adapter A.	<i>Auto</i>								
	Auto	Source of the Status word is chosen automatically.	0								
	Transparent mode	The source selected by parameter <i>50.09 FBA A SW transparent source</i> is transmitted as the Status word to the fieldbus network through fieldbus adapter A.	1								
50.07	<i>FBA A actual 1 type</i>	Selects the type and scaling of actual value 1 transmitted to the fieldbus network through fieldbus adapter A. The scaling of the value is defined by parameters <i>46.01...46.04</i> , depending on which actual value type is selected by this parameter.	<i>Speed or frequency</i>								
	Speed or frequency	Type and scaling is chosen automatically according to the currently active operation mode as follows: <table border="1" data-bbox="344 1002 840 1133"> <thead> <tr> <th>Operation mode (see par. 19.01)</th> <th>Actual value 1 type</th> </tr> </thead> <tbody> <tr> <td>Speed control</td> <td><i>Speed</i></td> </tr> <tr> <td>Torque control</td> <td><i>Speed</i></td> </tr> <tr> <td>Frequency control</td> <td><i>Frequency</i></td> </tr> </tbody> </table>	Operation mode (see par. 19.01)	Actual value 1 type	Speed control	<i>Speed</i>	Torque control	<i>Speed</i>	Frequency control	<i>Frequency</i>	0
Operation mode (see par. 19.01)	Actual value 1 type										
Speed control	<i>Speed</i>										
Torque control	<i>Speed</i>										
Frequency control	<i>Frequency</i>										
	Transparent	The value selected by parameter <i>50.10 FBA A act1 transparent source</i> is sent as actual value 1. No scaling is applied (the 16-bit scaling is 1 = 1 unit).	1								
	General	The value selected by parameter <i>50.10 FBA A act1 transparent source</i> is sent as actual value 1 with a 16-bit scaling of 100 = 1 unit (ie. integer and two decimals).	2								
	Torque	<i>01.10 Motor torque</i> is sent as actual value 1. The scaling is defined by parameter <i>46.03 Torque scaling</i> .	3								
	Speed	<i>01.01 Motor speed used</i> is sent as actual value 1. The scaling is defined by parameter <i>46.01 Speed scaling</i> .	4								
	Frequency	<i>01.06 Output frequency</i> is sent as actual value 1. The scaling is defined by parameter <i>46.02 Frequency scaling</i> .	5								

No.	Name/Value	Description	Def/FbEq16								
50.08	<i>FBA A actual 2 type</i>	Selects the type and scaling of actual value 2 transmitted to the fieldbus network through fieldbus adapter A. The scaling of the value is defined by parameters <a href="#">46.01...46.04</a> , depending on which actual value type is selected by this parameter.	<i>Speed or frequency</i>								
	Speed or frequency	Type and scaling is chosen automatically according to the currently active operation mode as follows: <table border="1" data-bbox="400 347 893 475"> <thead> <tr> <th>Operation mode (see par. <a href="#">19.01</a>)</th> <th>Actual value 2 type</th> </tr> </thead> <tbody> <tr> <td>Speed control</td> <td><i>Torque</i></td> </tr> <tr> <td>Torque control</td> <td><i>Torque</i></td> </tr> <tr> <td>Frequency control</td> <td><i>Torque</i></td> </tr> </tbody> </table>	Operation mode (see par. <a href="#">19.01</a> )	Actual value 2 type	Speed control	<i>Torque</i>	Torque control	<i>Torque</i>	Frequency control	<i>Torque</i>	0
Operation mode (see par. <a href="#">19.01</a> )	Actual value 2 type										
Speed control	<i>Torque</i>										
Torque control	<i>Torque</i>										
Frequency control	<i>Torque</i>										
	Transparent	The value selected by parameter <a href="#">50.11 FBA A act2 transparent source</a> is sent as actual value 1. No scaling is applied (the 16-bit scaling is 1 = 1 unit).	1								
	General	The value selected by parameter <a href="#">50.11 FBA A act2 transparent source</a> is sent as actual value 1 with a 16-bit scaling of 100 = 1 unit (ie. integer and two decimals).	2								
	Torque	<a href="#">01.10 Motor torque</a> is sent as actual value 1. The scaling is defined by parameter <a href="#">46.03 Torque scaling</a> .	3								
	Speed	<a href="#">01.01 Motor speed used</a> is sent as actual value 1. The scaling is defined by parameter <a href="#">46.01 Speed scaling</a> .	4								
	Frequency	<a href="#">01.06 Output frequency</a> is sent as actual value 1. The scaling is defined by parameter <a href="#">46.02 Frequency scaling</a> .	5								
50.09	<i>FBA A SW transparent source</i>	Selects the source of the fieldbus status word when parameter <a href="#">50.06 FBA A SW sel</a> is set to <i>Transparent mode</i> .	<i>Not selected</i>								
	Not selected	No source selected.	-								
	<i>Other</i>	Source selection (see <a href="#">Terms and abbreviations</a> on page <a href="#">196</a> ).	-								
50.10	<i>FBA A act1 transparent source</i>	When parameter <a href="#">50.07 FBA A actual 1 type</a> is set to <i>Transparent</i> , this parameter selects the source of actual value 1 transmitted to the fieldbus network through fieldbus adapter A.	<i>Not selected</i>								
	Not selected	No source selected.	-								
	<i>Other</i>	Source selection (see <a href="#">Terms and abbreviations</a> on page <a href="#">196</a> ).	-								
50.11	<i>FBA A act2 transparent source</i>	When parameter <a href="#">50.08 FBA A actual 2 type</a> is set to <i>Transparent</i> , this parameter selects the source of actual value 2 transmitted to the fieldbus network through fieldbus adapter A.	<i>Not selected</i>								
	Not selected	No source selected.	-								
	<i>Other</i>	Source selection (see <a href="#">Terms and abbreviations</a> on page <a href="#">196</a> ).	-								
50.12	<i>FBA A debug mode</i>	This parameter enables debug mode. Displays raw (unmodified) data received from and sent to fieldbus adapter A in parameters <a href="#">50.13...50.18</a> .	<i>Disable</i>								
	Disable	Debug mode disabled.	0								
	Fast	Debug mode enabled. Cyclical data update is as fast as possible which increases CPU load on the drive.	1								

No.	Name/Value	Description	Def/FbEq16
50.13	<i>FBA A control word</i>	Displays the raw (unmodified) control word sent by the master (PLC) to fieldbus adapter A if debugging is enabled by parameter <i>50.12 FBA A debug mode</i> . This parameter is read-only.	-
	0000000h... FFFFFFFFh	Control word sent by master to fieldbus adapter A.	-
50.14	<i>FBA A reference 1</i>	Displays raw (unmodified) reference REF1 sent by the master (PLC) to fieldbus adapter A if debugging is enabled by parameter <i>50.12 FBA A debug mode</i> . This parameter is read-only.	-
	-2147483648... 2147483647	Raw REF1 sent by master to fieldbus adapter A.	-
50.15	<i>FBA A reference 2</i>	Displays raw (unmodified) reference REF2 sent by the master (PLC) to fieldbus adapter A if debugging is enabled by parameter <i>50.12 FBA A debug mode</i> . This parameter is read-only.	-
	-2147483648... 2147483647	Raw REF2 sent by master to fieldbus adapter A.	-
50.16	<i>FBA A status word</i>	Displays the raw (unmodified) status word sent by fieldbus adapter A to the master (PLC) if debugging is enabled by parameter <i>50.12 FBA A debug mode</i> . This parameter is read-only.	-
	0000000h... FFFFFFFFh	Status word sent by fieldbus adapter A to master.	-
50.17	<i>FBA A actual value 1</i>	Displays raw (unmodified) actual value ACT1 sent by fieldbus adapter A to the master (PLC) if debugging is enabled by parameter <i>50.12 FBA A debug mode</i> . This parameter is read-only.	-
	-2147483648... 2147483647	Raw ACT1 sent by fieldbus adapter A to master.	-
50.18	<i>FBA A actual value 2</i>	Displays raw (unmodified) actual value ACT2 sent by fieldbus adapter A to the master (PLC) if debugging is enabled by parameter <i>50.12 FBA A debug mode</i> . This parameter is read-only.	-
	-2147483648... 2147483647	Raw ACT2 sent by fieldbus adapter A to master.	-

<b>51 FBA A settings</b>		Fieldbus adapter A configuration.	
51.01	<i>FBA A type</i>	Displays the type of the connected fieldbus adapter module. If value is <b>0</b> = None, module is not found or is not properly connected, or is disabled by parameter <i>50.01 FBA A enable</i> . <b>1</b> = PROFIBUS-DP <b>32</b> = CANopen <b>37</b> = DeviceNet <b>128</b> = Ethernet <b>132</b> = PROFINet IO <b>135</b> = EtherCAT <b>136</b> = ETH Pwlink <b>485</b> = RS-485 comm <b>101</b> = ControlNet <b>2222</b> = Ethernet/IP <b>502</b> = Modbus/TCP This parameter is read-only.	-

No.	Name/Value	Description	Def/FbEq16
51.02	<i>FBA A Par2</i>	Parameters <i>51.02...51.26</i> are adapter module-specific. For more information, see the documentation of the fieldbus adapter module. Note that not all of these parameters are necessarily in use.	-
	0...65535	Fieldbus adapter configuration parameter.	1 = 1
...	...	...	...
51.26	<i>FBA A Par26</i>	See parameter <i>51.02 FBA A Par2</i> .	-
	0...65535	Fieldbus adapter configuration parameter.	1 = 1
51.27	<i>FBA A par refresh</i>	Validates any changed fieldbus adapter module configuration settings. After refreshing, the value reverts automatically to <i>Done</i> . <b>Note:</b> This parameter cannot be changed while the drive is running.	<i>Done</i>
	Done	Refreshing done.	0
	Configure	Refreshing.	1
51.28	<i>FBA A par table ver</i>	Displays the parameter table revision of the fieldbus adapter module mapping file (stored in the memory of the drive). In format axyz, where ax = major table revision number; yz = minor table revision number. This parameter is read-only.	-
		Parameter table revision of adapter module.	-
51.29	<i>FBA A drive type code</i>	Displays the drive type code in the fieldbus adapter module mapping file (stored in the memory of the drive). This parameter is read-only.	-
	0...65535	Drive type code stored in the mapping file.	1 = 1
51.30	<i>FBA A mapping file ver</i>	Displays the fieldbus adapter module mapping file revision stored in the memory of the drive in decimal format. This parameter is read-only.	-
	0...65535	Mapping file revision.	1 = 1
51.31	<i>D2FBA A comm status</i>	Displays the status of the fieldbus adapter module communication.	<i>Not configured</i>
	Not configured	Adapter is not configured.	0
	Initializing	Adapter is initializing.	1
	Time out	A timeout has occurred in the communication between the adapter and the drive.	2
	Configuration error	Adapter configuration error: mapping file not found in the file system of the drive, or mapping file upload has failed more than three times.	3
	Off-line	Fieldbus communication is off-line.	4
	On-line	Fieldbus communication is on-line, or fieldbus adapter has been configured not to detect a communication break. For more information, see the documentation of the fieldbus adapter.	5
	Reset	Adapter is performing a hardware reset.	6
51.32	<i>FBA A comm SW ver</i>	Displays the common program revision of the adapter module in format axyz, where a = major revision number, xy = minor revision number, z = correction number or letter. Example: 190A = revision 1.90A.	-
		Common program revision of adapter module.	-

## 392 Parameters

No.	Name/Value	Description	Def/FbEq16
51.33	<i>FBA A appl SW ver</i>	Displays the application program revision of the adapter module in format axyz, where a = major revision number, xy = minor revision number, z = correction number or letter. Example: 190A = revision 1.90A.	
		Application program version of adapter module.	-
<b>52 FBA A data in</b>		Selection of data to be transferred from drive to fieldbus controller through fieldbus adapter A. <b>Note:</b> 32-bit values require two consecutive parameters. Whenever a 32-bit value is selected in a data parameter, the next parameter is automatically reserved.	
52.01	<i>FBA A data in1</i>	Parameters <i>52.01...52.12</i> select data to be transferred from the drive to the fieldbus controller through fieldbus adapter A.	<i>None</i>
	None	None.	0
	CW 16bit	Control Word (16 bits)	1
	Ref1 16bit	Reference REF1 (16 bits)	2
	Ref2 16bit	Reference REF2 (16 bits)	3
	SW 16bit	Status Word (16 bits)	4
	Act1 16bit	Actual value ACT1 (16 bits)	5
	Act2 16bit	Actual value ACT2 (16 bits)	6
	Reserved		7...10
	CW 32bit	Control Word (32 bits)	11
	Ref1 32bit	Reference REF1 (32 bits)	12
	Ref2 32bit	Reference REF2 (32 bits)	13
	SW 32bit	Status Word (32 bits)	14
	Act1 32bit	Actual value ACT1 (32 bits)	15
	Act2 32bit	Actual value ACT2 (32 bits)	16
	Reserved		17...23
	SW2 16bit	Status Word 2 (16 bits)	24
	<i>Other</i>	Source selection (see <i>Terms and abbreviations</i> on page 196).	-
...	...	...	...
52.12	<i>FBA A data in12</i>	See parameter <i>52.01 FBA A data in1</i> .	<i>None</i>
<b>53 FBA A data out</b>		Selection of data to be transferred from fieldbus controller to drive through fieldbus adapter A. <b>Note:</b> 32-bit values require two consecutive parameters. Whenever a 32-bit value is selected in a data parameter, the next parameter is automatically reserved.	
53.01	<i>FBA A data out1</i>	Parameters <i>53.01...53.12</i> select data to be transferred from the fieldbus controller to the drive through fieldbus adapter A.	<i>None</i>
	None	None.	0
	CW 16bit	Control Word (16 bits)	1
	Ref1 16bit	Reference REF1 (16 bits)	2
	Ref2 16bit	Reference REF2 (16 bits)	3
	Reserved		7...10
	CW 32bit	Control Word (32 bits)	11



No.	Name/Value	Description	Def/FbEq16
	Ref1 32bit	Reference REF1 (32 bits)	12
	Ref2 32bit	Reference REF2 (32 bits)	13
	Reserved		14...20
	CW2 16bit	Control Word 2 (16 bits)	21
	<i>Other</i>	Source selection (see <i>Terms and abbreviations</i> on page 196).	-
...	...	...	...
53.12	<i>FBA A data out12</i>	See parameter 53.01 <i>FBA A data out1</i> .	<i>None</i>

<b>58 Embedded fieldbus</b>		Configuration of the embedded fieldbus (EFB) interface. See also chapter <i>Fieldbus control through the embedded fieldbus interface (EFB)</i> (page 505).	
58.01	<i>Protocol enable</i>	Enables/disables the embedded fieldbus interface and selects the protocol to use.	<i>None</i>
	None	None (communication disabled).	0
	Modbus RTU	Embedded fieldbus interface is enabled and uses the Modbus RTU protocol.	1
58.02	<i>Protocol ID</i>	Displays the protocol ID and revision. First 4 bits specify the protocol ID and last 12 bits specify the revision. This parameter is read-only.	-
		Protocol ID and revision.	1 = 1
58.03	<i>Node address</i>	Defines the node address of the drive on the fieldbus link. Values 1...247 are allowable. Also called Station ID, MAC Address or Device Address. Two devices with the same address are not allowed on-line. Changes to this parameter take effect after the control unit is rebooted or the new settings validated by parameter 58.06 <i>Communication control (Refresh settings)</i> .	1
	0...255	Node address (values 1...247 are allowed).	1 = 1
58.04	<i>Baud rate</i>	Selects the transfer rate of the fieldbus link. When using selection <i>Autodetect</i> , the parity setting of the bus must be known and configured in parameter 58.05 <i>Parity</i> . When parameter 58.04 <i>Baud rate</i> is set to <i>Autodetect</i> , the EFB settings must be refreshed with parameter 58.06. The bus is monitored for a period of time and the detected baud rate is set as the value of this parameter. Changes to this parameter take effect after the control unit is rebooted or the new settings validated by parameter 58.06 <i>Communication control (Refresh settings)</i> .	Modbus: 19.2 kbps
	Autodetect	Baud rate detected automatically.	0
	4.8 kbps	4.8 kbit/s.	1
	9.6 kbps	9.6 kbit/s.	2
	19.2 kbps	19.2 kbit/s.	3
	38.4 kbps	38.4 kbit/s.	4
	57.6 kbps	57.6 kbit/s.	5
	76.8 kbps	76.8 kbit/s.	6
	115.2 kbps	115.2 kbit/s.	7

No.	Name/Value	Description	Def/FbEq16
58.05	<i>Parity</i>	Selects the type of parity bit and number of stop bits. Changes to this parameter take effect after the control unit is rebooted or the new settings validated by parameter 58.06 <i>Communication control (Refresh settings)</i> .	8 EVEN 1
	8 NONE 1	Eight data bits, no parity bit, one stop bit.	0
	8 NONE 2	Eight data bits, no parity bit, two stop bits.	1
	8 EVEN 1	Eight data bits, even parity bit, one stop bit.	2
	8 ODD 1	Eight data bits, odd parity bit, one stop bit.	3
58.06	<i>Communication control</i>	Takes changed EFB settings in use, or activates silent mode.	Enabled
	Enabled	Normal operation.	0
	Refresh settings	Refreshes settings (parameters 58.01...58.05, 58.14...58.17, 58.25, 58.28...58.34) and takes changed EFB configuration settings in use. Reverts automatically to <i>Enabled</i> .	1
	Silent mode	Activates silent mode (no messages are transmitted). Silent mode can be terminated by activating the <i>Refresh settings</i> selection of this parameter.	2
58.07	<i>Communication diagnostics</i>	Displays the status of the EFB communication. This parameter is read-only. Note that the name is only visible when the error is present (bit value is 1).	-



  

Bit	Name	Description
0	Init failed	1 = EFB initialization failed
1	Addr config err	1 = Node address not allowed by protocol
2	Silent mode	1 = Drive not allowed to transmit
		0 = Drive allowed to transmit
3	Autobauding	1 = Automatic detection of baud rate is in use (see parameter 58.04)
4	Wiring error	1 = Errors detected (A/B wires possibly swapped)
5	Parity error	1 = Error detected: check parameters 58.04 and 58.05
6	Baud rate error	1 = Error detected: check parameters 58.05 and 58.04
7	No bus activity	1 = 0 bytes received during last 5 seconds
8	No packets	1 = 0 packets (addressed to any device) detected during last 5 seconds
9	Noise or addressing error	1 = Errors detected (interference, or another device with the same address on line)
10	Comm loss	1 = 0 packets addressed to the drive received within timeout (58.16)
11	CW/Ref loss	1 = No control word or references received within timeout (58.16)
12	Reserved	
13	Protocol 1	Reserved
14	Protocol 2	Reserved
15	Internal error	1 = Internal error occurred. Contact your local ABB representative.

0000h...FFFFh	EFB communication status.	1 = 1
---------------	---------------------------	-------

No.	Name/Value	Description	Def/FbEq16
58.08	<i>Received packets</i>	Displays a count of valid packets addressed to the drive. During normal operation, this number increases constantly. Can be reset from the control panel by keeping Reset down for over 3 seconds.	-
	0...4294967295	Number of received packets addressed to the drive.	1 = 1
58.09	<i>Transmitted packets</i>	Displays a count of valid packets transmitted by the drive. During normal operation, this number increases constantly. Can be reset from the control panel by keeping Reset down for over 3 seconds.	-
	0...4294967295	Number of transmitted packets.	1 = 1
58.10	<i>All packets</i>	Displays a count of valid packets addressed to any device on the bus. During normal operation, this number increases constantly. Can be reset from the control panel by keeping Reset down for over 3 seconds.	-
	0...4294967295	Number of all received packets.	1 = 1
58.11	<i>UART errors</i>	Displays a count of character errors received by the drive. An increasing count indicates a configuration problem on the bus. Can be reset from the control panel by keeping Reset down for over 3 seconds.	-
	0...4294967295	Number of UART errors.	1 = 1
58.12	<i>CRC errors</i>	Displays a count of packets with a CRC error received by the drive. An increasing count indicates interference on the bus. Can be reset from the control panel by keeping Reset down for over 3 seconds.	-
	0...4294967295	Number of CRC errors.	1 = 1
58.14	<i>Communication loss action</i>	Selects how the drive reacts to an EFB communication break. Changes to this parameter take effect after the control unit is rebooted or the new settings validated by parameter <a href="#">58.06 Communication control (Refresh settings)</a> . See also parameters <a href="#">58.15 Communication loss mode</a> and <a href="#">58.16 Communication loss time</a> .	<i>No action</i>
	No action	No action taken (monitoring disabled).	0
	Fault	The drive monitors communication loss when start/stop is expected from the EFB on the currently active control location. The drive trips on <a href="#">6681 EFB comm loss</a> if control in the currently active control location is expected from the EFB or reference is coming from the EFB, and the communication is lost.	1
	Last speed	Drive generates an <a href="#">A7CE EFB comm loss</a> warning and freezes the speed to the level the drive was operating at. The speed is determined on the basis of actual speed using 850 ms low-pass filtering. This occurs if control or reference is expected from the EFB.  <b>WARNING!</b> Make sure that it is safe to continue operation in case of a communication break.	2

No.	Name/Value	Description	Def/FbEq16
	Speed ref safe	Drive generates an <i>A7CE EFB comm loss</i> warning and sets the speed to the speed defined by parameter <i>22.41 Speed ref safe</i> (or <i>28.41 Frequency ref safe</i> when frequency reference is being used). This occurs if control or reference is expected from the EFB.  <b>WARNING!</b> Make sure that it is safe to continue operation in case of a communication break.	3
	Fault always	Drive continuously monitors for communication loss. Drive trips on <i>6681 EFB comm loss</i> . This happens even though the drive is in a control location where the EFB start/stop or reference is not used.	4
	Warning	Drive generates an <i>A7CE EFB comm loss</i> warning. This occurs even though no control is expected from the EFB.  <b>WARNING!</b> Make sure that it is safe to continue operation in case of a communication break.	5
<i>58.15</i>	<i>Communication loss mode</i>	Defines which message types reset the timeout counter for detecting an EFB communication loss. Changes to this parameter take effect after the control unit is rebooted or the new settings validated by parameter <i>58.06 Communication control (Refresh settings)</i> . See also parameters <i>58.14 Communication loss action</i> and <i>58.16 Communication loss time</i> .	<i>Cw / Ref1 / Ref2</i>
	Any message	Any message addressed to the drive resets the timeout.	1
	Cw / Ref1 / Ref2	A write of the control word or a reference resets the timeout.	2
<i>58.16</i>	<i>Communication loss time</i>	Sets a timeout for EFB communication. If a communication break lasts longer than the timeout, the action specified by parameter <i>58.14 Communication loss action</i> is taken. Changes to this parameter take effect after the control unit is rebooted or the new settings validated by parameter <i>58.06 Communication control (Refresh settings)</i> . See also parameter <i>58.15 Communication loss mode</i> . <b>Note:</b> There is a 30-second boot-up delay immediately after power-up.	30.0 s
	0.0...6000.0 s	EFB communication timeout.	1 = 1
<i>58.17</i>	<i>Transmit delay</i>	Defines a minimum response delay in addition to any fixed delay imposed by the protocol. Changes to this parameter take effect after the control unit is rebooted or the new settings validated by parameter <i>58.06 Communication control (Refresh settings)</i> .	0 ms
	0...65535 ms	Minimum response delay.	1 = 1
<i>58.18</i>	<i>EFB control word</i>	Displays the raw (unmodified) control word sent by the Modbus controller to the drive. For debugging purposes. This parameter is read-only.	-
	0000000h... FFFFFFFFh	Control word sent by Modbus controller to the drive.	1 = 1
<i>58.19</i>	<i>EFB status word</i>	Displays the raw (unmodified) status word for debugging purposes. This parameter is read-only.	-
	0000000h... FFFFFFFFh	Status word sent by the drive to the Modbus controller.	1 = 1

No.	Name/Value	Description	Def/FbEq16								
58.25	<i>Control profile</i>	Defines the communication profile used by the Modbus protocol. Changes to this parameter take effect after the control unit is rebooted or the new settings validated by parameter <a href="#">58.06 Communication control (Refresh settings)</a> . See section <a href="#">About the control profiles</a> on page 514.	<a href="#">ABB Drives</a>								
	ABB Drives	ABB Drives control profile (with a 16-bit control word)	0								
	DCU Profile	DCU control profile (with a 16 or 32-bit control word)	5								
58.26	<i>EFB ref1 type</i>	Selects the type and scaling of reference 1 received through the embedded fieldbus interface. The scaled reference is displayed by <a href="#">03.09 EFB reference 1</a> .	<a href="#">Speed or frequency</a>								
	Speed or frequency	Type and scaling is chosen automatically according to the currently active operation mode as follows. <table border="1" data-bbox="400 518 896 651"> <thead> <tr> <th>Operation mode (see par. <a href="#">19.01</a>)</th> <th>Reference 1 type</th> </tr> </thead> <tbody> <tr> <td>Speed control</td> <td><a href="#">Speed</a></td> </tr> <tr> <td>Torque control</td> <td><a href="#">Speed</a></td> </tr> <tr> <td>Frequency control</td> <td><a href="#">Frequency</a></td> </tr> </tbody> </table>	Operation mode (see par. <a href="#">19.01</a> )	Reference 1 type	Speed control	<a href="#">Speed</a>	Torque control	<a href="#">Speed</a>	Frequency control	<a href="#">Frequency</a>	0
Operation mode (see par. <a href="#">19.01</a> )	Reference 1 type										
Speed control	<a href="#">Speed</a>										
Torque control	<a href="#">Speed</a>										
Frequency control	<a href="#">Frequency</a>										
	Transparent	No scaling is applied.	1								
	General	Generic reference without a specific unit. Scaling: 1 = 100.	2								
	Torque	Torque reference. The scaling is defined by parameter <a href="#">46.03 Torque scaling</a> .	3								
	Speed	Speed reference. The scaling is defined by parameter <a href="#">46.01 Speed scaling</a> .	4								
	Frequency	Frequency reference. The scaling is defined by parameter <a href="#">46.02 Frequency scaling</a> .	5								
58.27	<i>EFB ref2 type</i>	Selects the type and scaling of reference 2 received through the embedded fieldbus interface. The scaled reference is displayed by <a href="#">03.10 EFB reference 2</a> .	<a href="#">Torque</a>								
58.28	<i>EFB act1 type</i>	Selects the type of actual value 1.	<a href="#">Speed or frequency</a>								
	Speed or frequency	Type and scaling is chosen automatically according to the currently active operation mode as follows. <table border="1" data-bbox="400 1093 896 1225"> <thead> <tr> <th>Operation mode (see par. <a href="#">19.01</a>)</th> <th>Actual 1 type</th> </tr> </thead> <tbody> <tr> <td>Speed control</td> <td><a href="#">Speed</a></td> </tr> <tr> <td>Torque control</td> <td><a href="#">Speed</a></td> </tr> <tr> <td>Frequency control</td> <td><a href="#">Frequency</a></td> </tr> </tbody> </table>	Operation mode (see par. <a href="#">19.01</a> )	Actual 1 type	Speed control	<a href="#">Speed</a>	Torque control	<a href="#">Speed</a>	Frequency control	<a href="#">Frequency</a>	0
Operation mode (see par. <a href="#">19.01</a> )	Actual 1 type										
Speed control	<a href="#">Speed</a>										
Torque control	<a href="#">Speed</a>										
Frequency control	<a href="#">Frequency</a>										
	Transparent	No scaling is applied.	1								
	General	Generic reference without a specific unit. Scaling: 1 = 100.	2								
	Torque	Scaling is defined by parameter <a href="#">46.03 Torque scaling</a> .	3								
	Speed	Scaling is defined by parameter <a href="#">46.01 Speed scaling</a> .	4								
	Frequency	Scaling is defined by parameter <a href="#">46.02 Frequency scaling</a> .	5								
58.29	<i>EFB act2 type</i>	Selects the type of actual value 2. For the selections, see parameter <a href="#">58.28 EFB act1 type</a> .	<a href="#">Transparent</a>								

No.	Name/Value	Description	Def/FbEq16
58.31	<i>EFB act1 transparent source</i>	Selects the source of actual value 1 when parameter <i>58.28 EFB act1 type</i> is set to <i>Transparent</i> .	<i>Not selected</i>
	Not selected	None.	0
	<i>Other</i>	Source selection (see <i>Terms and abbreviations</i> on page 196).	-
58.32	<i>EFB act2 transparent source</i>	Selects the source of actual value 2 when parameter <i>58.29 EFB act2 type</i> is set to <i>Transparent</i> .	<i>Not selected</i>
	Not selected	None.	0
	<i>Other</i>	Source selection (see <i>Terms and abbreviations</i> on page 196).	-
58.33	<i>Addressing mode</i>	Defines the mapping between parameters and holding registers in the 400101...465535 Modbus register range. Changes to this parameter take effect after the control unit is rebooted or the new settings validated by parameter <i>58.06 Communication control (Refresh settings)</i> .	<i>Mode 0</i>
	Mode 0	<u>16-bit values (groups 1...99, indexes 1...99):</u> Register address = 400000 + 100 × parameter group + parameter index. For example, parameter 22.80 would be mapped to register 400000 + 2200 + 80 = 402280. <u>32-bit values (groups 1...99, indexes 1...99):</u> Register address = 420000 + 200 × parameter group + 2 × parameter index. For example, parameter 22.80 would be mapped to register 420000 + 4400 + 160 = 424560.	0
	Mode 1	<u>16-bit values (groups 1...255, indexes 1...255):</u> Register address = 400000 + 256 × parameter group + parameter index. For example, parameter 22.80 would be mapped to register 400000 + 5632 + 80 = 405712.	1
	Mode 2	<u>32-bit values (groups 1...127, indexes 1...255):</u> Register address = 400000 + 512 × parameter group + 2 × parameter index. For example, parameter 22.80 would be mapped to register 400000 + 11264 + 160 = 411424.	2
58.34	<i>Word order</i>	Selects in which order 16-bit registers of 32-bit parameters are transferred. For each register, the first byte contains the high order byte and the second byte contains the low order byte. Changes to this parameter take effect after the control unit is rebooted or the new settings validated by parameter <i>58.06 Communication control (Refresh settings)</i> .	<i>LO-HI</i>
	HI-LO	The first register contains the high order word, the second contains the low order word.	0
	LO-HI	The first register contains the low order word, the second contains the high order word.	1
58.101	<i>Data I/O 1</i>	Defines the address in the drive which the Modbus master accesses when it reads from or writes to the register address corresponding to Modbus register 1 (400001). The master defines the type of the data (input or output). The value is transmitted in a Modbus frame consisting of two 16-bit words. If the value is 16-bit, it is transmitted in the LSW (least significant word). If the value is 32-bit, the subsequent parameter is also reserved for it and must be set to <i>None</i> .	<i>CW 16bit</i>
	None	No mapping, register is always zero.	0
	CW 16bit	<i>ABB Drives</i> profile: 16-bit ABB drives control word; <i>DCU Profile</i> : lower 16 bits of the DCU control word	1
	Ref1 16bit	Reference REF1 (16 bits)	2

No.	Name/Value	Description	Def/FbEq16
	Ref2 16bit	Reference REF2 (16 bits)	3
	SW 16bit	<i>ABB Drives</i> profile: 16-bit ABB drives status word; <i>DCU Profile</i> : lower 16 bits of the DCU status word	4
	Act1 16bit	Actual value ACT1 (16 bits)	5
	Act2 16bit	Actual value ACT2 (16 bits)	6
	Reserved		7...10
	CW 32bit	Control Word (32 bits)	11
	Ref1 32bit	Reference REF1 (32 bits)	12
	Ref2 32bit	Reference REF2 (32 bits)	13
	SW 32bit	Status Word (32 bits)	14
	Act1 32bit	Actual value ACT1 (32 bits)	15
	Act2 32bit	Actual value ACT2 (32 bits)	16
	Reserved		17...20
	CW2 16bit	<i>ABB Drives</i> profile: not used; <i>DCU Profile</i> : upper 16 bits of the DCU control word	21
	SW2 16bit	<i>ABB Drives</i> profile: not used / always zero; <i>DCU Profile</i> : upper 16 bits of the DCU status word	24
	Reserved		25...30
	RO/DIO control word	Parameter <a href="#">10.99 RO/DIO control word</a> .	31
	AO1 data storage	Parameter <a href="#">13.91 AO1 data storage</a> .	32
	AO2 data storage	Parameter <a href="#">13.92 AO2 data storage</a> .	33
	Reserved		34...39
	Feedback data storage	Parameter <a href="#">40.91 Feedback data storage</a> .	40
	Setpoint data storage	Parameter <a href="#">40.92 Setpoint data storage</a> .	41
	<i>Other</i>	Source selection (see <a href="#">Terms and abbreviations</a> on page 196).	-
<a href="#">58.102</a>	<a href="#">Data I/O 2</a>	Defines the address in the drive which the Modbus master accesses when it reads from or writes to register address 400002. For the selections, see parameter <a href="#">58.101 Data I/O 1</a> .	<i>Ref1 16bit</i>
<a href="#">58.103</a>	<a href="#">Data I/O 3</a>	Defines the address in the drive which the Modbus master accesses when it reads from or writes to register address 400003. For the selections, see parameter <a href="#">58.101 Data I/O 1</a> .	<i>Ref2 16bit</i>
<a href="#">58.104</a>	<a href="#">Data I/O 4</a>	Defines the address in the drive which the Modbus master accesses when it reads from or writes to register address 400004. For the selections, see parameter <a href="#">58.101 Data I/O 1</a> .	<i>SW 16bit</i>
<a href="#">58.105</a>	<a href="#">Data I/O 5</a>	Defines the address in the drive which the Modbus master accesses when it reads from or writes to register address 400005. For the selections, see parameter <a href="#">58.101 Data I/O 1</a> .	<i>Act1 16bit</i>
<a href="#">58.106</a>	<a href="#">Data I/O 6</a>	Defines the address in the drive which the Modbus master accesses when it reads from or writes to register address 400006. For the selections, see parameter <a href="#">58.101 Data I/O 1</a> .	<i>Act2 16bit</i>

No.	Name/Value	Description	Def/FbEq16
58.107	Data I/O 7	Parameter selector for Modbus register address 400007. For the selections, see parameter <a href="#">58.101 Data I/O 1</a> .	None
...	...	...	...
58.114	Data I/O 14	Parameter selector for Modbus register address 400014. For the selections, see parameter <a href="#">58.101 Data I/O 1</a> .	None

71 External PID1		Description	Def/FbEq16
		Configuration of external PID. See the control chain diagrams on pages <a href="#">565</a> and <a href="#">566</a> .	
71.01	External PID act value	See parameter <a href="#">40.01 Process PID output actual</a> .	-
71.02	Feedback act value	See parameter <a href="#">40.02 Process PID feedback actual</a> .	-
71.03	Setpoint act value	See parameter <a href="#">40.03 Process PID setpoint actual</a> .	-
71.04	Deviation act value	See parameter <a href="#">40.04 Process PID deviation actual</a> .	-
71.06	PID status word	Displays status information on process external PID control. This parameter is read-only.	-

Bit	Name	Value
0	PID active	1 = Process PID control active.
1	Reserved	
2	Output frozen	1 = Process PID controller output frozen. Bit is set if parameter <a href="#">71.38 Output freeze enable</a> is TRUE, or the deadband function is active (bit 9 is set).
3...6	Reserved	
7	Output limit high	1 = PID output is being limited by par. <a href="#">71.37</a> .
8	Output limit low	1 = PID output is being limited by par. <a href="#">71.36</a> .
9	Deadband active	1 = Deadband is active (see par. <a href="#">71.39</a> )
10...11	Reserved	
12	Internal setpoint active	1 = Internal setpoint active (see par. <a href="#">71.16...71.23</a> )
13...15	Reserved	

0000h...FFFFh	Process PID control status word.	1 = 1	
71.07	PID operation mode	See parameter <a href="#">40.07 Process PID operation mode</a> .	Off
71.08	Feedback 1 source	See parameter <a href="#">40.08 Set 1 feedback 1 source</a> .	A/2 percent
71.11	Feedback filter time	See parameter <a href="#">40.11 Set 1 feedback filter time</a> .	0.000 s
71.14	Setpoint scaling	Defines, together with parameter <a href="#">71.15 Output scaling</a> , a general scaling factor for the external PID control chain. The scaling can be utilized when, for example, the process setpoint is input in Hz, and the output of the PID controller is used as an rpm value in speed control. In this case, this parameter might be set to 50, and parameter <a href="#">71.15</a> to the nominal motor speed at 50 Hz. In effect, the output of the PID controller [ <a href="#">71.15</a> ] when deviation (setpoint - feedback) = [ <a href="#">71.14</a> ] and [ <a href="#">71.32</a> ] = 1. <b>Note:</b> The scaling is based on the ratio between <a href="#">71.14</a> and <a href="#">71.15</a> . For example, the values 50 and 1500 would produce the same scaling as 1 and 3.	1500.00
-200000.00... 200000.00	Process setpoint base.		1 = 1
71.15	Output scaling	See parameter <a href="#">71.14 Setpoint scaling</a> .	1500.00



No.	Name/Value	Description	Def/FbEq16
	-200000.00... 200000.00	Process PID controller output base.	1 = 1
71.16	<i>Setpoint 1 source</i>	See parameter <i>40.16 Set 1 setpoint 1 source</i> .	<i>AI2 percent</i>
71.19	<i>Internal setpoint sel1</i>	See parameter <i>40.19 Set 1 internal setpoint sel1</i> .	<i>Not selected</i>
71.20	<i>Internal setpoint sel2</i>	See parameter <i>40.20 Set 1 internal setpoint sel2</i> .	<i>Not selected</i>
71.21	<i>Internal setpoint 1</i>	See parameter <i>40.21 Set 1 internal setpoint 1</i> .	0.00 PID customer units
71.22	<i>Internal setpoint 2</i>	See parameter <i>40.22 Set 1 internal setpoint 2</i> .	0.00 PID customer units
71.23	<i>Internal setpoint 3</i>	See parameter <i>40.23 Set 1 internal setpoint 3</i> .	0.00 PID customer units
71.26	<i>Setpoint min</i>	See parameter <i>40.26 Set 1 setpoint min</i> .	0.00 PID customer units
71.27	<i>Setpoint max</i>	See parameter <i>40.27 Set 1 setpoint max</i> .	200000.00 PID customer units
71.31	<i>Deviation inversion</i>	See parameter <i>40.31 Set 1 deviation inversion</i> .	<i>Not inverted (Ref - Fbk)</i>
71.32	<i>Gain</i>	See parameter <i>40.32 Set 1 gain</i> .	1.00
71.33	<i>Integration time</i>	See parameter <i>40.33 Set 1 integration time</i> .	60.0 s
71.34	<i>Derivation time</i>	See parameter <i>40.34 Set 1 derivation time</i> .	0.000 s
71.35	<i>Derivation filter time</i>	See parameter <i>40.35 Set 1 derivation filter time</i> .	0.0 s
71.36	<i>Output min</i>	See parameter <i>40.36 Set 1 output min</i> .	-200000.00
71.37	<i>Output max</i>	See parameter <i>40.37 Set 1 output max</i> .	200000.00
71.38	<i>Output freeze enable</i>	See parameter <i>40.38 Set 1 output freeze enable</i> .	<i>Not selected</i>
71.39	<i>Deadband range</i>	The control program compares the absolute value of parameter <i>71.04 Deviation act value</i> to the deadband range defined by this parameter. If the absolute value is within the deadband range for the time period defined by parameter <i>71.40 Deadband delay</i> , PID's deadband mode is activated and <i>71.06 PID status word</i> bit 9 <i>Deadband active</i> is set. Then PID's output is frozen and <i>71.06 PID status word</i> bit 2 <i>Output frozen</i> is set. If the absolute value is equal or greater than the deadband range, PID's deadband mode is deactivated.	0.0
	0.0...200000.0 PID customer units	Range	1 = 1 PID customer unit
71.40	<i>Deadband delay</i>	Defines the deadband delay for the deadband function. See parameter <i>71.39 Deadband range</i> .	0.0 s
	0.0...3600.0 s	Delay	1 = 1 s
71.58	<i>Increase prevention</i>	See parameter <i>40.58 Set 1 increase prevention</i> .	<i>No</i>
	No	Increase prevention not in use.	0

## 402 Parameters

No.	Name/Value	Description	Def/FbEq16
	Limiting	The PID integration term is not increased if the maximum value for the PID output is reached. This parameter is valid for the PID set 1.	1
	Process PID min lim	The process PID integration term is not increased when the output of the external PID has reached its minimum limit. In this setup, the external PID is used as a source for the process PID.	2
	Process PID max lim	The process PID integration term is not increased when the output of the external PID has reached its maximum limit. In this setup, the external PID is used as a source for the process PID.	3
	<i>Other</i>	Source selection (see <a href="#">Terms and abbreviations</a> on page 196).	-
<a href="#">71.59</a>	<a href="#">Decrease prevention</a>	See parameter <a href="#">40.59 Set 1 decrease prevention</a> .	No
	No	Decrease prevention not in use.	0
	Limiting	The PID integration term is not decreased if the maximum value for the PID output is reached. This parameter is valid for the PID set 1.	1
	Process PID min lim	The process PID integration term is not decreased when the output of the external PID has reached its minimum limit. In this setup, the external PID is used as a source for the process PID.	2
	Process PID max lim	The process PID integration term is not decreased when the output of the external PID has reached its maximum limit. In this setup, the external PID is used as a source for the process PID.	3
	<i>Other</i>	Source selection (see <a href="#">Terms and abbreviations</a> on page 196).	-
<a href="#">71.62</a>	<a href="#">Internal setpoint actual</a>	See parameter <a href="#">40.62 PID internal setpoint actual</a> .	-
<a href="#">71.79</a>	<a href="#">External PID units</a>	Unit used for external PID.	%
		For selections, see parameter <a href="#">40.79 Set 1 units</a> .	

No.	Name/Value	Description	Def/FbEq16																								
<b>76 PFC configuration</b>		PFC (Pump and fan control) and Autochange configuration parameters. See also section <i>Pump and fan control (PFC)</i> on page 142.																									
76.01	<i>PFC status</i>	Displays the running/stopped status of the PFC motors. PFC1, PFC2, PFC3, PFC4, PFC5 and PFC6 always correspond to the 1st...6th motor of the PFC system. If <i>76.74 Autochange auxiliary PFC</i> auxiliary PFC is set to <i>Aux motors only</i> , PFC1 represents the motor connected to the drive and PFC2 the first auxiliary motor (the 2nd motor of the system). If <i>76.74</i> is set to <i>All motors</i> , PFC1 is the first motor, PFC2 the 2nd. The drive can be connected to any of these motors depending on the Autochange functionality.	-																								
<table border="1"> <thead> <tr> <th>Bit</th> <th>Name</th> <th>Value</th> </tr> </thead> <tbody> <tr> <td>0</td> <td>PFC 1 running</td> <td>0 = Stop, 1 = Start</td> </tr> <tr> <td>1</td> <td>PFC 2 running</td> <td>0 = Stop, 1 = Start</td> </tr> <tr> <td>2</td> <td>PFC 3 running</td> <td>0 = Stop, 1 = Start</td> </tr> <tr> <td>3</td> <td>PFC 4 running</td> <td>0 = Stop, 1 = Start</td> </tr> <tr> <td>4</td> <td>PFC 5 running</td> <td>0 = Stop, 1 = Start</td> </tr> <tr> <td>5</td> <td>PFC 6 running</td> <td>0 = Stop, 1 = Start</td> </tr> <tr> <td>6...15</td> <td>Reserved</td> <td></td> </tr> </tbody> </table>				Bit	Name	Value	0	PFC 1 running	0 = Stop, 1 = Start	1	PFC 2 running	0 = Stop, 1 = Start	2	PFC 3 running	0 = Stop, 1 = Start	3	PFC 4 running	0 = Stop, 1 = Start	4	PFC 5 running	0 = Stop, 1 = Start	5	PFC 6 running	0 = Stop, 1 = Start	6...15	Reserved	
Bit	Name	Value																									
0	PFC 1 running	0 = Stop, 1 = Start																									
1	PFC 2 running	0 = Stop, 1 = Start																									
2	PFC 3 running	0 = Stop, 1 = Start																									
3	PFC 4 running	0 = Stop, 1 = Start																									
4	PFC 5 running	0 = Stop, 1 = Start																									
5	PFC 6 running	0 = Stop, 1 = Start																									
6...15	Reserved																										
0000h...FFFFh		Status of the PFC relay outputs.	1 = 1																								
76.02	<i>Multipump system status</i>	Displays the status of the PFC system in text form. Provides a quick PFC system overview, for example, if the parameter is added to the Home view on the control panel.	<i>PFC disabled</i>																								
PFC disabled		PFC (Pump and fan control) is disabled.	0																								
PFC enabled (not started)		PFC is enabled but not started.	1																								
SPFC enabled (not started)		SPFC (Soft pump and fan control) is enabled but not started.	2																								
Running with VSD		The drive is controlling one pump/fan motor, no auxiliary motors are used.	100																								
Running with VSD + 1 Aux		One auxiliary motor has been taken in use.	101																								
Running with VSD + 2 Aux		Two auxiliary motor have been taken in use.	102																								
Running with VSD + 3 Aux		Three auxiliary motor have been taken in use.	103																								
Running with VSD + 4 Aux		Four auxiliary motor have been taken in use.	104																								
Running with VSD + 5 Aux		Five auxiliary motor have been taken in use.	105																								
Starting Aux1		Auxiliary motor 1 is being started.	200																								
Starting Aux2		Auxiliary motor 2 is being started.	201																								
Starting Aux3		Auxiliary motor 3 is being started.	202																								
Starting Aux4		Auxiliary motor 4 is being started.	203																								
Starting Aux5		Auxiliary motor 5 is being started.	204																								
Stopping Aux1		Auxiliary motor 1 is being stopped.	300																								

No.	Name/Value	Description	Def/FbEq16																											
	Stopping Aux2	Auxiliary motor 2 is being stopped.	301																											
	Stopping Aux3	Auxiliary motor 3 is being stopped.	302																											
	Stopping Aux4	Auxiliary motor 4 is being stopped.	303																											
	Stopping Aux5	Auxiliary motor 5 is being stopped.	304																											
	Autochange active	Autochange, that is, automatic rotation of the start order is active.	400																											
	No auxiliary motors available to be started	No auxiliary motors are available to be started, for example, all are already running, or a motor is not available due to maintenance.	500																											
	Regulator bypass active	Direct-on-line pumps are automatically started and stopped.	600																											
	PID sleep	PID sleep is in use, and the pump can be stopped in during low demand.	800																											
	PID sleep boost	PID sleep with extended sleep time is in use, and the pump can be stopped in during low demand.	801																											
	Invalid configuration	PFC configuration is invalid.	4																											
	PFC inactive (local control)	PFC is inactive because the drive is in local control.	5																											
	PFC inactive (invalid operation mode)	PFC is inactive because of an invalid operation mode.	6																											
	Drive motor interlocked	The motor connected to the drive is interlocked (not available). Warning <i>D503 VSD controlled PFC motor interlocked</i> (page 492) is generated.	7																											
	All motors interlocked	All motors are interlocked (not available). Warning <i>D502 All motors interlocked</i> (page 492) is generated.	8																											
	PFC inactive (ext1 active)	PFC is inactive because external control location EXT1 is in use. PFC is supported in EXT2 only.	9																											
76.11	<i>Pump/fan status 1</i>	Shows the status of pump or fan 1.	-																											
		<table border="1"> <thead> <tr> <th>Bit</th> <th>Name</th> <th>Value</th> </tr> </thead> <tbody> <tr> <td>0</td> <td>Ready</td> <td>0 = False, 1 = True</td> </tr> <tr> <td>1</td> <td>Reserved</td> <td></td> </tr> <tr> <td>2</td> <td>Running</td> <td>0 = False, 1 = True</td> </tr> <tr> <td>3...4</td> <td>Reserved</td> <td></td> </tr> <tr> <td>5</td> <td>In PFC control</td> <td>0 = False, 1 = True</td> </tr> <tr> <td>6...10</td> <td>Reserved</td> <td></td> </tr> <tr> <td>11</td> <td>Interlocked</td> <td>0 = False, 1 = True</td> </tr> <tr> <td>12...15</td> <td>Reserved</td> <td></td> </tr> </tbody> </table>	Bit	Name	Value	0	Ready	0 = False, 1 = True	1	Reserved		2	Running	0 = False, 1 = True	3...4	Reserved		5	In PFC control	0 = False, 1 = True	6...10	Reserved		11	Interlocked	0 = False, 1 = True	12...15	Reserved		
Bit	Name	Value																												
0	Ready	0 = False, 1 = True																												
1	Reserved																													
2	Running	0 = False, 1 = True																												
3...4	Reserved																													
5	In PFC control	0 = False, 1 = True																												
6...10	Reserved																													
11	Interlocked	0 = False, 1 = True																												
12...15	Reserved																													
	0000h...FFFFh	Status of pump or fan 1.	1 = 1																											
76.12	<i>Pump/fan status 2</i>	See parameter 76.11 <i>Pump/fan status 1</i> .	-																											
76.13	<i>Pump/fan status 3</i>	See parameter 76.11 <i>Pump/fan status 1</i> .	-																											
76.14	<i>Pump/fan status 4</i>	See parameter 76.11 <i>Pump/fan status 1</i> .	-																											
76.15	<i>Pump/fan status 5</i>	See parameter 76.11 <i>Pump/fan status 1</i> .	-																											
76.16	<i>Pump/fan status 6</i>	See parameter 76.11 <i>Pump/fan status 1</i> .	-																											

No.	Name/Value	Description	Def/FbEq16
<a href="#">76.21</a>	<a href="#">Multipump configuration</a>	Selects the multipump/fan control (PFC) mode.	<i>Off</i>
	Off	PFC disabled.	0
	Reserved		1
	PFC	PFC enabled. One pump at a time is controlled by the drive. The remaining pumps are direct-on-line pumps that are started and stopped by the drive logic The frequency (group <a href="#">28 Frequency reference chain</a> ) / speed (group <a href="#">22 Speed reference selection</a> ) reference must be defined as PID for the PFC functionality to work properly.	2
	SPFC	SPFC enabled. See section <a href="#">Soft pump and fan control (SPFC)</a> on page <a href="#">143</a> .	3
<a href="#">76.25</a>	<a href="#">Number of motors</a>	Total number of motors used in the application, including the motor connected directly to the drive.	1
	1...6	Number of motors.	1 = 1
<a href="#">76.26</a>	<a href="#">Min number of motors allowed</a>	Minimum number of motors running simultaneously.	1
	0...6	Minimum number of motors.	1 = 1
<a href="#">76.27</a>	<a href="#">Max number of motors allowed</a>	Maximum number of motors running simultaneously.	1
	1...6	Maximum number of motors.	1 = 1

No.	Name/Value	Description	Def/FbEq16
76.30	<i>Start point 1</i>	<p>Defines the start point for the first auxiliary motor. As the motor speed or frequency (defined by the PID output value) exceeds the limit defined by this parameter, a new auxiliary motor is started.</p> <p>To avoid nuisance starts of the second auxiliary motor, the speed of the variable speed motor should be higher than the start speed for the duration defined by parameter <a href="#">76.55 Start delay</a>. If the speed decreases below the start speed, the auxiliary motor is not started.</p> <p>To maintain the process conditions during the start of the second auxiliary motor, a speed hold on time can be defined with parameter <a href="#">76.57 PFC speed hold on</a>. Certain pump types do not produce significant flow with low frequencies. The speed hold on time can be used to compensate the time needed to accelerate the second auxiliary motor to a speed where it produces flow. The start of the second auxiliary motor is not aborted if the speed of the first auxiliary motor decreases.</p>	Vector: 1300 rpm; Scalar 48 Hz; 58 Hz <a href="#">(95.20 b0)</a>
0...32767 rpm/Hz	Speed/frequency.	1 = 1 unit	
76.31	<i>Start point 2</i>	Defines the start speed (Hz/rpm) for the second auxiliary motor. See parameter <a href="#">76.31 Start point 1</a> .	Vector: 1300 rpm; Scalar 48 Hz; 58 Hz <a href="#">(95.20 b0)</a>
76.32	<i>Start point 3</i>	Defines the start speed (Hz/rpm) for the third auxiliary motor. See parameter <a href="#">76.31 Start point 1</a> .	Vector: 1300 rpm; Scalar 48 Hz; 58 Hz <a href="#">(95.20 b0)</a>
76.33	<i>Start point 4</i>	Defines the start speed (Hz/rpm) for the fourth auxiliary motor. See parameter <a href="#">76.31 Start point 1</a> .	Vector: 1300 rpm; Scalar 48 Hz; 58 Hz <a href="#">(95.20 b0)</a>

No.	Name/Value	Description	Def/FbEq16
76.34	<i>Start point 5</i>	Defines the start speed (Hz/rpm) for the fifth auxiliary motor. See parameter <a href="#">76.31 Start point 1</a> .	Vector: 1300 rpm; Scalar 48 Hz; 58 Hz (95.20 b0)
76.41	<i>Stop point 1</i>	Defines the stop speed (Hz/rpm) for the first auxiliary motor. When the speed (defined by the PID output value) of the motor connected directly to the drive falls below this value and one auxiliary motor is running, the stop delay defined by parameter <a href="#">76.56 Stop delay</a> is started. If the speed is still at the same level or lower when the stop delay elapses, the first auxiliary motor stops. The running speed of the drive is increased by [ <a href="#">Start point 1 - Stop point 1</a> ] after the auxiliary motor stops.	Vector: 800 rpm; Scalar 25 Hz; 30 Hz (95.20 b0)
	0...32767 rpm/Hz	Speed/frequency	1 = 1 unit
76.42	<i>Stop point 2</i>	Defines the stop speed (Hz/rpm) for the second auxiliary motor. See parameter <a href="#">76.31 Stop point 1</a> .	Vector: 800 rpm; Scalar 25 Hz; 30 Hz (95.20 b0)
76.43	<i>Stop point 3</i>	Defines the stop speed (Hz/rpm) for the third auxiliary motor. See parameter <a href="#">76.31 Stop point 1</a> .	Vector: 800 rpm; Scalar 25 Hz; 30 Hz (95.20 b0)
76.44	<i>Stop point 4</i>	Defines the stop speed (Hz/rpm) for the fourth auxiliary motor. See parameter <a href="#">76.31 Stop point 1</a> .	Vector: 800 rpm; Scalar 25 Hz; 30 Hz (95.20 b0)
76.45	<i>Stop point 5</i>	Defines the stop speed (Hz/rpm) for the fifth auxiliary motor. See parameter <a href="#">76.31 Stop point 1</a> .	Vector: 800 rpm; Scalar 25 Hz; 30 Hz (95.20 b0)
76.55	<i>Start delay</i>	Defines a start delay for auxiliary motors. See parameter <a href="#">76.31 Start point 1</a> .	10.00 s
	0.00...12600.00 s	Time delay.	1 = 1 s
76.56	<i>Stop delay</i>	Defines a stop delay for auxiliary motors. See parameter <a href="#">76.31 Stop point 1</a> .	10.00 s
	0.00...12600.00 s	Time delay.	1 = 1 s
76.57	<i>PFC speed hold on</i>	Hold time for auxiliary motor switch-on. See parameter <a href="#">76.31 Start point 1</a> .	0.00 s
	0.00...1000.00 s	Time.	1 = 1 s
76.58	<i>PFC speed hold off</i>	Hold time for auxiliary motor switch-off. See parameter <a href="#">76.31 Stop point 1</a> .	0.00 s
	0.00...1000.00 s	Time.	1 = 1 s

No.	Name/Value	Description	Def/FbEq16
76.59	<i>PFC contactor delay</i>	Start delay for the motor that is directly controlled by the drive. This does not affect the starting of the auxiliary motors.  <b>WARNING!</b> There must always be a delay set if the motors are equipped with star-delta starters. The delay must be set longer than the time setting of the starter. After the motor is switched on by the relay output of the drive, there must be enough time for the star-delta starter to first switch to star and then back to delta before the motor is connected to the drive.	0.50 s
	0.20...600.00 s	Time delay.	1 = 1 s
76.60	<i>PFC ramp acceleration time</i>	Defines the acceleration time for the drive motor speed compensation, when an auxiliary motor is stopped. This ramp time is also used for the drive motor to accelerate after an autochange has occurred. Defines the acceleration time if the latest reference received by the drive is higher than the previous reference. This parameter is used also to accelerate the pump when the auxiliary pump is started. The parameter sets the ramp-up time as seconds from zero to maximum frequency (not from the previous reference to the new reference).	1.00 s
	0.00...1800.00 s	Time.	1 = 1 s
76.61	<i>PFC ramp deceleration time</i>	Defines the deceleration time for the drive motor speed compensation, when an auxiliary motor is stopped. This ramp time is also used for the drive motor to decelerate after an autochange has occurred. Defines the deceleration time if the latest reference received by the drive is lower than the previous reference. This parameter is used also to decelerate the pump when the auxiliary pump is stopped. The parameter sets the ramp-down time as seconds from maximum to zero frequency (not from the previous reference to the new reference).	1.00 s
	0.00...1800.00 s	Time.	1 = 1 s
76.70	<i>PFC autochange</i>	Defines the way the autochange is triggered. In all cases except <i>Even wear</i> , the start order is moved one step forward each time the autochange occurs. If the start order initially is 1-2-3-4, after the first autochange the order will be 2-3-4-1, etc. For <i>Even wear</i> , the start order will be determined so that the running times of all motors remain within the defined limit. <b>Note:</b> Autochange only occurs when the speed of the drive is below the speed defined by parameter <i>76.73 Autochange level</i> . See also section <i>Autochange</i> on page 145.	<i>Not selected</i>
	Not selected	Autochange disabled.	0
	Selected	Rising edge starts the autochange if autochange conditions are met.	1
	DI1	Autochange triggered by the rising edge of digital input DI1 ( <i>10.02 DI delayed status</i> , bit 0).	2
	DI2	Autochange triggered by the rising edge of digital input DI2 ( <i>10.02 DI delayed status</i> , bit 1).	3
	DI3	Autochange triggered by the rising edge of digital input DI3 ( <i>10.02 DI delayed status</i> , bit 2).	4



No.	Name/Value	Description	Def/FbEq16
	DI4	Autochange triggered by the rising edge of digital input DI4 ( <a href="#">10.02 DI delayed status</a> , bit 3).	5
	DI5	Autochange triggered by the rising edge of digital input DI5 ( <a href="#">10.02 DI delayed status</a> , bit 4).	6
	DI6	Autochange triggered by the rising edge of digital input DI6 ( <a href="#">10.02 DI delayed status</a> , bit 5).	7
	Timed function 1	Autochange triggered by timed function 1 (bit 0 of <a href="#">34.01 Timed functions status</a> (see page 327)).	8
	Timed function 2	Autochange triggered by timed function 2 (bit 1 of <a href="#">34.01 Timed functions status</a> (see page 327)).	9
	Timed function 3	Autochange triggered by timed function 3 (bit 2 of <a href="#">34.01 Timed functions status</a> (see page 327)).	10
	Fixed interval	Autochange is done when the interval determined in the parameter <a href="#">76.71 PFC autochange interval</a> has elapsed.	11
	All stop	Autochange is done when all the motors are stopped. The PID sleep feature (parameters <a href="#">40.43 Set 1 sleep level ... 40.48 Set 1 wake-up delay</a> ) must be used for the drive to stop when the process demand is low.	12
	Even wear	The running time of the motors are balanced by the drive. When the difference in running time between the motors with the least and most running hours exceeds the time defined by parameter <a href="#">76.72 Maximum wear imbalance</a> , the autochange occurs. The running hours of the motors can be found in group <a href="#">77 PFC maintenance and monitoring</a> .	13
	<i>Other [bit]</i>	Source selection (see <a href="#">Terms and abbreviations</a> on page 196).	-
<a href="#">76.71</a>	<a href="#">PFC autochange interval</a>	Specifies the interval that is used in setting <a href="#">Fixed interval</a> of parameter <a href="#">76.70 PFC autochange</a> .	1.00 h
	0.00...42949672.95 h	Time.	1 = 1 h
<a href="#">76.72</a>	<a href="#">Maximum wear imbalance</a>	Specifies the maximum wear imbalance, or difference in running times between any motor, used by the <a href="#">Even wear</a> setting of parameter <a href="#">76.70 PFC autochange</a> .	10.00 h
	0.00...1000000.00 h	Time.	1 = 1 h
<a href="#">76.73</a>	<a href="#">Autochange level</a>	Upper speed limit for the Autochange to occur. The Autochange occurs when: <ul style="list-style-type: none"> <li>the condition defined in <a href="#">76.70 PFC autochange</a> is fulfilled and,</li> <li>the speed of the drive motor <a href="#">01.03 Motor speed %</a> is below the speed limit defined in this parameter.</li> </ul> <b>Note:</b> When the value is selected as 0%, this speed limit check is disabled.	100.0%
	0.0...300.0%	Speed/frequency in percentage of the nominal speed or frequency of the drive motor.	1 = 1%
<a href="#">76.74</a>	<a href="#">Autochange auxiliary PFC</a>	Selects whether only auxiliary motors or all motors are included in the Autochange function.	<a href="#">Aux motors only</a>

## 410 Parameters

No.	Name/Value	Description	Def/FbEq16
	All motors	All motors, including the one connected to the drive participates in the autochange. The Autochange logic will connect the drive to each of the motors according to setting of parameter <a href="#">76.70 PFC autochange</a> . <b>Note:</b> The first motor (PFC1) also requires the appropriate hardware contactor connections and PFC1 must be defined in one of the relay output source parameters.	0
	Aux motors only	Only auxiliary (direct-on-line) motors are affected by the autochange function. <b>Note:</b> PFC1 refers to the motor that is fixed to the drive and must not be selected in any of the relay output source parameters. Only the starting order of the auxiliary motors will be rotated.	1
<a href="#">76.81</a>	<a href="#">PFC 1 interlock</a>	Defines if the PFC motor 1 can be started. An interlocked PFC motor cannot be started. 0 = Interlocked (not available), 1 = Available.	<a href="#">Available.</a> <a href="#">PFC motor is available</a>
	Interlocked. PFC motor is not in use	PFC motor is interlocked and not available.	0
	Available. PFC motor is available	PFC motor is available.	1
	DI1	Digital input DI1 ( <a href="#">10.02 DI delayed status</a> , bit 0).	2
	DI2	Digital input DI2 ( <a href="#">10.02 DI delayed status</a> , bit 1).	3
	DI3	Digital input DI3 ( <a href="#">10.02 DI delayed status</a> , bit 2).	4
	DI4	Digital input DI4 ( <a href="#">10.02 DI delayed status</a> , bit 3).	5
	DI5	Digital input DI5 ( <a href="#">10.02 DI delayed status</a> , bit 4).	6
	DI6	Digital input DI6 ( <a href="#">10.02 DI delayed status</a> , bit 5).	7
	Timed function 1	Bit 0 of <a href="#">34.01 Timed functions status</a> (see page <a href="#">327</a> ).	8
	Timed function 2	Bit 1 of <a href="#">34.01 Timed functions status</a> (see page <a href="#">327</a> ).	9
	Timed function 3	Bit 2 of <a href="#">34.01 Timed functions status</a> (see page <a href="#">327</a> ).	10
	<a href="#">Other [bit]</a>	Source selection (see <a href="#">Terms and abbreviations</a> on page <a href="#">196</a> ).	-
<a href="#">76.82</a>	<a href="#">PFC 2 interlock</a>	See parameter <a href="#">76.81 PFC 1 interlock</a> .	<a href="#">Available.</a> <a href="#">PFC motor is available</a>
<a href="#">76.83</a>	<a href="#">PFC 3 interlock</a>	See parameter <a href="#">76.81 PFC 1 interlock</a> .	<a href="#">Available.</a> <a href="#">PFC motor is available</a>
<a href="#">76.84</a>	<a href="#">PFC 4 interlock</a>	See parameter <a href="#">76.81 PFC 1 interlock</a> .	<a href="#">Available.</a> <a href="#">PFC motor is available</a>
<a href="#">76.85</a>	<a href="#">PFC 5 interlock</a>	See parameter <a href="#">76.81 PFC 1 interlock</a> .	<a href="#">Available.</a> <a href="#">PFC motor is available</a>
<a href="#">76.86</a>	<a href="#">PFC 6 interlock</a>	See parameter <a href="#">76.81 PFC 1 interlock</a> .	<a href="#">Available.</a> <a href="#">PFC motor is available</a>
<a href="#">76.95</a>	<a href="#">Regulator bypass control</a>	Defines if direct-on-line pumps are automatically started and stopped. This setting can be used in applications with a low number of sensors and low accuracy requirements.	<a href="#">Disable</a>
	Disable	Digital input DI2 ( <a href="#">10.02 DI delayed status</a> , bit 1).	0

No.	Name/Value	Description	Def/FbEq16
	Enable	Digital input DI3 ( <i>10.02 DI delayed status</i> , bit 2).	1
	<i>Other [bit]</i>	Source selection (see <i>Terms and abbreviations</i> on page 196).	-
<b>77 PFC maintenance and monitoring</b>		PFC (Pump and fan control) maintenance and monitoring parameters.	
<i>77.10</i>	<i>PFC runtime change</i>	Enables the reset, or arbitrary setting, of <i>77.11 Pump/fan 1 running time ... 77.14 Pump/fan 4 running time</i> .	<i>Done</i>
	Done	The parameter automatically reverts back to this value.	0
	Set any PFC run time	Enables the setting of <i>77.11 Pump/fan 1 running time ... 77.14 Pump/fan 4 running time</i> to an arbitrary value.	1
	Reset PFC1 run time	Resets parameter <i>77.11 Pump/fan 1 running time</i> .	2
	Reset PFC2 run time	Resets parameter <i>77.12 Pump/fan 2 running time</i> .	3
	Reset PFC3 run time	Resets parameter <i>77.13 Pump/fan 3 running time</i> .	4
	Reset PFC4 run time	Resets parameter <i>77.14 Pump/fan 4 running time</i> .	5
	Reset PFC5 run time	Resets parameter <i>77.15 Pump/fan 5 running time</i> .	6
	Reset PFC6 run time	Resets parameter <i>77.16 Pump/fan 6 running time</i> .	7
<i>77.11</i>	<i>Pump/fan 1 running time</i>	Running time counter of pump/fan 1. Can be set or reset by parameter <i>77.10 Pump/fan 1 running time</i> .	0.00 h
	0.00... 42949672.95 h	Time	1 = 1 h
<i>77.12</i>	<i>Pump/fan 2 running time</i>	See parameter <i>77.11 Pump/fan 1 running time</i> .	0.00 h
<i>77.13</i>	<i>Pump/fan 3 running time</i>	See parameter <i>77.11 Pump/fan 1 running time</i> .	0.00 h
<i>77.14</i>	<i>Pump/fan 4 running time</i>	See parameter <i>77.11 Pump/fan 1 running time</i> .	0.00 h
<i>77.15</i>	<i>Pump/fan 5 running time</i>	See parameter <i>77.11 Pump/fan 1 running time</i> .	0.00 h
<i>77.16</i>	<i>Pump/fan 6 running time</i>	See parameter <i>77.11 Pump/fan 1 running time</i> .	0.00 h

## 412 Parameters

No.	Name/Value	Description	Def/FbEq16
<b>95 HW configuration</b>			
95.01	<i>Supply voltage</i>	<p>Selects the supply voltage range. This parameter is used by the drive to determine the nominal voltage of the supply network. The parameter also affects the current ratings and the DC voltage control functions (trip and brake chopper activation limits) of the drive.</p> <p> <b>WARNING!</b> An incorrect setting may cause the motor to rush uncontrollably, or the brake chopper or resistor to overload.</p> <p><b>Note:</b> The selections shown depend on the hardware of the drive. If only one voltage range is valid for the drive in question, it is selected by default.</p>	<i>Automatic / not selected</i>
	Automatic / not selected	No voltage range selected. The drive will not start modulating before a range is selected, unless parameter <i>95.02 Adaptive voltage limits</i> is set to <i>Enable</i> , in which case the drive estimates the supply voltage itself.	0
	208...240 V	208...240 V	1
	380...415 V	380...415 V	2
	440...480 V	440...480 V	3
	525...600 V	525...600 V	5
95.02	<i>Adaptive voltage limits</i>	<p>Enables adaptive voltage limits.</p> <p>Adaptive voltage limits can be used if, for example, an IGBT supply unit is used to raise the DC voltage level. If the communication between the inverter and IGBT supply unit is active, the voltage limits are related to the DC voltage reference from the IGBT supply unit. Otherwise the limits are calculated based on the measured DC voltage at the end of the pre-charging sequence.</p> <p>This function is also useful if the AC supply voltage to the drive is high, as the warning levels are raised accordingly.</p>	<i>Enable</i>
	Disable	Adaptive voltage limits disabled.	0
	Enable	Adaptive voltage limits enabled.	1
95.03	<i>Estimated AC supply voltage</i>	AC supply voltage estimated by calculation. Estimation is done every time the drive is powered up and is based on the rise speed of voltage level of the DC bus while the drive charges the DC bus.	-
	0...65535 V	Voltage.	10 = 1 V
95.04	<i>Control board supply</i>	Specifies how the control unit of the drive is powered.	<i>Internal 24V</i>
	Internal 24V	The drive control unit is powered from the drive power unit it is connected to.	0
	External 24V	The drive control unit is powered from an external power supply.	1

No.	Name/Value	Description	Def/FbEq16															
95.15	<i>Special HW settings</i>	<p>Contains hardware-related settings that can be enabled and disabled by toggling the specific bits.</p> <p><b>Notes:</b></p> <ul style="list-style-type: none"> <li>The installation of the hardware specified by this parameter may require derating of drive output, or impose other limitations. Refer to the <i>Hardware manual</i> of the drive.</li> <li>With the CPTC-02 ATEX-certified thermistor protection module, follow the instructions given in the <i>CPTC-02 ATEX-certified thermistor protection module, Ex II (2) GD (+L537+Q971) user's manual</i> (3AXD50000030058 [English]).</li> </ul>	0000h															
<table border="1"> <thead> <tr> <th>Bit</th> <th>Name</th> <th>Information</th> </tr> </thead> <tbody> <tr> <td>0</td> <td>EX motor</td> <td> <p>1 = The driven motor is an Ex motor provided by ABB for potentially explosive atmospheres. This sets the required minimum switching frequency for ABB Ex motors.</p> <p><b>Notes:</b></p> <ul style="list-style-type: none"> <li>For non-ABB Ex motors, use parameters <a href="#">97.01</a> and <a href="#">97.02</a> to define the correct minimum switching frequency.</li> <li>If you have a multimotor system, contact your local ABB representative.</li> </ul> </td> </tr> <tr> <td>1</td> <td>ABB Sine filter</td> <td>1 = An ABB sine filter is connected to the output of the drive.</td> </tr> <tr> <td>2...15</td> <td colspan="2">Reserved</td> </tr> </tbody> </table>				Bit	Name	Information	0	EX motor	<p>1 = The driven motor is an Ex motor provided by ABB for potentially explosive atmospheres. This sets the required minimum switching frequency for ABB Ex motors.</p> <p><b>Notes:</b></p> <ul style="list-style-type: none"> <li>For non-ABB Ex motors, use parameters <a href="#">97.01</a> and <a href="#">97.02</a> to define the correct minimum switching frequency.</li> <li>If you have a multimotor system, contact your local ABB representative.</li> </ul>	1	ABB Sine filter	1 = An ABB sine filter is connected to the output of the drive.	2...15	Reserved				
Bit	Name	Information																
0	EX motor	<p>1 = The driven motor is an Ex motor provided by ABB for potentially explosive atmospheres. This sets the required minimum switching frequency for ABB Ex motors.</p> <p><b>Notes:</b></p> <ul style="list-style-type: none"> <li>For non-ABB Ex motors, use parameters <a href="#">97.01</a> and <a href="#">97.02</a> to define the correct minimum switching frequency.</li> <li>If you have a multimotor system, contact your local ABB representative.</li> </ul>																
1	ABB Sine filter	1 = An ABB sine filter is connected to the output of the drive.																
2...15	Reserved																	
0000000h...FFFFFFFFh		Hardware options configuration word.	1 = 1															
95.20	<i>HW options word 1</i>	<p>Specifies hardware-related options that require differentiated parameter defaults.</p> <p>This parameter is not affected by a parameter restore.</p>	0000 0000 0000 0000b															
<table border="1"> <thead> <tr> <th>Bit</th> <th>Name</th> <th>Value</th> </tr> </thead> <tbody> <tr> <td>0</td> <td>Supply frequency 60 Hz</td> <td> <p>See section <a href="#">Differences in the default values between 50 Hz and 60 Hz supply frequency settings</a> on page 437.</p> <p>0 = 50 Hz. 1 = 60 Hz.</p> </td> </tr> <tr> <td>1...12</td> <td colspan="2">Reserved</td> </tr> <tr> <td>13</td> <td>du/dt filter activation</td> <td> <p>When active, an external du/dt filter is connected to the drive/inverter output. The setting will limit the output switching frequency, and force the fan of the drive/inverter module to full speed.</p> <p>0 = du/dt filter inactive. 1 = du/dt filter active.</p> </td> </tr> <tr> <td>14...15</td> <td colspan="2">Reserved</td> </tr> </tbody> </table>				Bit	Name	Value	0	Supply frequency 60 Hz	<p>See section <a href="#">Differences in the default values between 50 Hz and 60 Hz supply frequency settings</a> on page 437.</p> <p>0 = 50 Hz. 1 = 60 Hz.</p>	1...12	Reserved		13	du/dt filter activation	<p>When active, an external du/dt filter is connected to the drive/inverter output. The setting will limit the output switching frequency, and force the fan of the drive/inverter module to full speed.</p> <p>0 = du/dt filter inactive. 1 = du/dt filter active.</p>	14...15	Reserved	
Bit	Name	Value																
0	Supply frequency 60 Hz	<p>See section <a href="#">Differences in the default values between 50 Hz and 60 Hz supply frequency settings</a> on page 437.</p> <p>0 = 50 Hz. 1 = 60 Hz.</p>																
1...12	Reserved																	
13	du/dt filter activation	<p>When active, an external du/dt filter is connected to the drive/inverter output. The setting will limit the output switching frequency, and force the fan of the drive/inverter module to full speed.</p> <p>0 = du/dt filter inactive. 1 = du/dt filter active.</p>																
14...15	Reserved																	
0000h...FFFh		Hardware options configuration word.	1 = 1															

## 414 Parameters

No.	Name/Value	Description	Def/FbEq16																		
95.21	<i>HW options word 2</i>	Specifies more hardware-related options that require differentiated parameter defaults. See parameter <a href="#">95.20 HW options word 1</a> .  <b>WARNING!</b> After switching any bits in this word, recheck the values of the affected parameters.	-																		
<table border="1"> <thead> <tr> <th>Bit</th> <th>Name</th> <th>Information</th> </tr> </thead> <tbody> <tr> <td>0...4</td> <td>Reserved</td> <td></td> </tr> <tr> <td>5</td> <td>Bypass present</td> <td>1 = Bypass is used.</td> </tr> <tr> <td>6</td> <td>Cabinet temp. supervision</td> <td>0 = Inactive, 1 = Active. Only for frame sizes R6 or larger.</td> </tr> <tr> <td>7</td> <td>Cabinet fan</td> <td>0 = Inactive, 1 = Active. Only for frame sizes R6 or larger.</td> </tr> <tr> <td>8...15</td> <td>Reserved</td> <td></td> </tr> </tbody> </table>				Bit	Name	Information	0...4	Reserved		5	Bypass present	1 = Bypass is used.	6	Cabinet temp. supervision	0 = Inactive, 1 = Active. Only for frame sizes R6 or larger.	7	Cabinet fan	0 = Inactive, 1 = Active. Only for frame sizes R6 or larger.	8...15	Reserved	
Bit	Name	Information																			
0...4	Reserved																				
5	Bypass present	1 = Bypass is used.																			
6	Cabinet temp. supervision	0 = Inactive, 1 = Active. Only for frame sizes R6 or larger.																			
7	Cabinet fan	0 = Inactive, 1 = Active. Only for frame sizes R6 or larger.																			
8...15	Reserved																				
	0000b...0101b	Hardware options configuration word 2.	1 = 1																		
95.26	<i>Motor disconnect detection</i>	<p>Detects if motor is disconnected and shows a warning of disconnected motor.</p> <p>When this parameter is enabled, the drive will do the followings:</p> <ol style="list-style-type: none"> <li>1. The drive detects if the motor is disconnected from the drive (all three phases).</li> <li>2. When a motor disconnection is detected, the drive will stay running and waits for the motor to be connected again. The drive shows warning <a href="#">A784 Motor disconnect</a> on the control panel.</li> <li>3. When motor connection is again detected, the motor returns back to the last active reference before the disconnection was detected.</li> <li>4. The warning message disappears from the panel</li> </ol> <p><b>Note:</b> This feature is only available in scalar control mode. This parameter does not affect vector control mode behavior.</p>	<i>Disable</i>																		
	Disable	Detecting of disconnected motor disabled.	0																		
	Enable	Detecting of disconnected motor enabled.	1																		
95.200	<i>Cooling fan mode</i>	Cooling fan operation mode.	<i>Auto</i>																		
	Auto	Fan runs normally: Fan on/off, fan speed reference can autochange according to the drive state.	0																		
	Always on	Fan always runs at 100% speed reference.	1																		

No.	Name/Value	Description	Def/FbEq16																																																																																								
<b>96 System</b>		Language selection; access levels; macro selection; parameter save and restore; control unit reboot; user parameter sets; unit selection; parameter checksum; user lock.																																																																																									
96.01	Language	<p>Selects the language of the parameter interface and other displayed information when viewed on the control panel.</p> <p>Drive supports multiple languages. The languages are divided in three firmware packages: Global, European and Asian.</p> <ul style="list-style-type: none"> <li>The default package is Global package that supports languages marked with <b>X</b> and <b>G</b>. European delta supports languages marked with <b>X</b> and <b>E</b>. Asian delta supports languages marked with <b>X</b> and <b>A</b>.</li> </ul>	<i>Not selected</i>																																																																																								
		<table border="1"> <thead> <tr> <th>Language</th> <th>Global package</th> <th>European</th> <th>Asian</th> </tr> </thead> <tbody> <tr><td>English</td><td>X</td><td>X</td><td>X</td></tr> <tr><td>German</td><td>X</td><td>X</td><td>X</td></tr> <tr><td>Spanish</td><td>X</td><td>X</td><td>X</td></tr> <tr><td>Portuguese</td><td>X</td><td>X</td><td>X</td></tr> <tr><td>French</td><td>X</td><td>X</td><td>X</td></tr> <tr><td>Chinese (Simplified)</td><td>X</td><td>X</td><td>X</td></tr> <tr><td>Italian</td><td>G</td><td></td><td></td></tr> <tr><td>Finnish</td><td>G</td><td></td><td></td></tr> <tr><td>Polish</td><td>G</td><td></td><td></td></tr> <tr><td>Russian</td><td>G</td><td></td><td></td></tr> <tr><td>Turkish</td><td>G</td><td></td><td></td></tr> <tr><td>Dutch</td><td></td><td>E</td><td></td></tr> <tr><td>Danish</td><td></td><td>E</td><td></td></tr> <tr><td>Swedish</td><td></td><td>E</td><td></td></tr> <tr><td>Czech</td><td></td><td>E</td><td></td></tr> <tr><td>Greek (Ellinika)</td><td></td><td>E</td><td></td></tr> <tr><td>Hungarian (Magyar)</td><td></td><td>E</td><td></td></tr> <tr><td>Hebrew</td><td></td><td>(E)</td><td></td></tr> <tr><td>Korean</td><td></td><td></td><td>A</td></tr> <tr><td>Japanese</td><td></td><td></td><td>A</td></tr> <tr><td>Thai</td><td></td><td></td><td>A</td></tr> </tbody> </table> <p>X = Common language, available in all packages  G = Available in Global package only  E = Available in European package only  (E) = Will be available later  A = Available in Asian package only</p>	Language	Global package	European	Asian	English	X	X	X	German	X	X	X	Spanish	X	X	X	Portuguese	X	X	X	French	X	X	X	Chinese (Simplified)	X	X	X	Italian	G			Finnish	G			Polish	G			Russian	G			Turkish	G			Dutch		E		Danish		E		Swedish		E		Czech		E		Greek (Ellinika)		E		Hungarian (Magyar)		E		Hebrew		(E)		Korean			A	Japanese			A	Thai			A	
Language	Global package	European	Asian																																																																																								
English	X	X	X																																																																																								
German	X	X	X																																																																																								
Spanish	X	X	X																																																																																								
Portuguese	X	X	X																																																																																								
French	X	X	X																																																																																								
Chinese (Simplified)	X	X	X																																																																																								
Italian	G																																																																																										
Finnish	G																																																																																										
Polish	G																																																																																										
Russian	G																																																																																										
Turkish	G																																																																																										
Dutch		E																																																																																									
Danish		E																																																																																									
Swedish		E																																																																																									
Czech		E																																																																																									
Greek (Ellinika)		E																																																																																									
Hungarian (Magyar)		E																																																																																									
Hebrew		(E)																																																																																									
Korean			A																																																																																								
Japanese			A																																																																																								
Thai			A																																																																																								

## 416 Parameters

No.	Name/Value	Description	Def/FbEq16
		<p>The drives include the language package corresponding to the order's geographical location. <b>No plus code or other actions are needed.</b></p> <p><b>Examples:</b></p> <ul style="list-style-type: none"> <li>• If the order is placed in Sweden, the drives will be delivered with the Global package (default package).</li> <li>• If the order is placed in Poland, the drives will be updated with European package before the delivery.</li> <li>• If the order is placed in Japan, the drives will be updated with Asian package before the delivery.</li> </ul> <p>All the language package variants are available from your local drives support.</p> <p><b>Notes:</b></p> <ul style="list-style-type: none"> <li>• Not all languages listed below are necessarily supported.</li> <li>• This parameter does not affect the languages visible in the Drive composer PC tool. (Those are specified under <b>View &gt; Settings &gt; Drive default language.</b>)</li> </ul>	
	Not selected	None.	0
	English	English.	1033
	Deutsch	German.	1031
	Italiano	Italian.	1040
	Español	Spanish.	3082
	Portugues	Portuguese.	2070
	Nederlands	Dutch.	1043
	Français	French.	1036
	Dansk	Danish.	1030
	Suomi	Finnish.	1035
	Svenska	Swedish.	1053
	Russki	Russian.	1049
	Polski	Polish.	1045
	Ceský	Czech.	1029
	Magyar	Hungarian.	1038
	Chinese (Simplified, PRC)	Simplified Chinese.	2052
	Türkçe	Turkish.	1055



No.	Name/Value	Description	Def/FbEq16																														
96.02	<i>Pass code</i>	<p>Pass codes can be entered into this parameter to activate further access levels (see parameter <a href="#">96.03 Access level status</a>) or to configure the user lock.</p> <p>Entering “358” toggles the parameter lock, which prevents the changing of all other parameters through the control panel or the Drive composer PC tool.</p> <p>Entering the user pass code (by default, “10000000”) enables parameters <a href="#">96.100...96.102</a>, which can be used to define a new user pass code and to select the actions that are to be prevented.</p> <p>Entering an invalid pass code will close the user lock if open, ie. hide parameters <a href="#">96.100...96.102</a>. After entering the code, check that the parameters are in fact hidden. If they are not, enter another (random) pass code.</p> <p><b>Note:</b> You must change the default user pass code to maintain a high level of cybersecurity. <u>Store the code in a safe place – THE PROTECTION CANNOT BE DISABLED EVEN BY ABB if the code is lost.</u></p> <p>See also section <a href="#">User lock</a> (page <a href="#">192</a>).</p>																															
	0...99999999	Pass code.	-																														
96.03	<i>Access level status</i>	Shows which access levels have been activated by pass codes entered into parameter <a href="#">96.02 Pass code</a> .	0001b																														
<table border="1"> <thead> <tr> <th>Bit</th> <th>Name</th> <th></th> </tr> </thead> <tbody> <tr> <td>0</td> <td>End user</td> <td>0 = Inactive, 1 = Active</td> </tr> <tr> <td>1</td> <td>Service</td> <td>0 = Inactive, 1 = Active</td> </tr> <tr> <td>2</td> <td>Advanced programmer</td> <td>0 = Inactive, 1 = Active</td> </tr> <tr> <td>3...10</td> <td>Reserved</td> <td></td> </tr> <tr> <td>11</td> <td>OEM access level 1</td> <td>0 = Inactive, 1 = Active</td> </tr> <tr> <td>12</td> <td>OEM access level 2</td> <td>0 = Inactive, 1 = Active</td> </tr> <tr> <td>13</td> <td>OEM access level 3</td> <td>0 = Inactive, 1 = Active</td> </tr> <tr> <td>14</td> <td>Parameter lock</td> <td>0 = Inactive, 1 = Active</td> </tr> <tr> <td>15</td> <td>Reserved</td> <td></td> </tr> </tbody> </table>				Bit	Name		0	End user	0 = Inactive, 1 = Active	1	Service	0 = Inactive, 1 = Active	2	Advanced programmer	0 = Inactive, 1 = Active	3...10	Reserved		11	OEM access level 1	0 = Inactive, 1 = Active	12	OEM access level 2	0 = Inactive, 1 = Active	13	OEM access level 3	0 = Inactive, 1 = Active	14	Parameter lock	0 = Inactive, 1 = Active	15	Reserved	
Bit	Name																																
0	End user	0 = Inactive, 1 = Active																															
1	Service	0 = Inactive, 1 = Active																															
2	Advanced programmer	0 = Inactive, 1 = Active																															
3...10	Reserved																																
11	OEM access level 1	0 = Inactive, 1 = Active																															
12	OEM access level 2	0 = Inactive, 1 = Active																															
13	OEM access level 3	0 = Inactive, 1 = Active																															
14	Parameter lock	0 = Inactive, 1 = Active																															
15	Reserved																																
	00000000h... FFFFFFFFh	Active access levels.	-																														
96.04	<i>Macro select</i>	<p>Selects the control macro. See chapter <a href="#">Control macros</a> (page <a href="#">77</a>) for more information.</p> <p>After a selection is made, the parameter reverts automatically to <a href="#">Done</a>.</p>	<i>Done</i>																														
	Done	Macro selection complete; normal operation.	0																														
	ABB standard	Factory macro (see page <a href="#">78</a> ). For scalar motor control.	1																														
	Hand/Auto	Hand/Auto macro (see page <a href="#">88</a> ).	2																														
	Hand/PID	Hand/PID macro (see page <a href="#">90</a> ).	3																														
	3-wire	3-wire macro see page <a href="#">78</a> ).	11																														
	Alternate	Alternate macro see page <a href="#">84</a> ).	12																														
	Motor potentiometer	Motor potentiometer macro (see page <a href="#">86</a> ).	13																														
	PID	PID macro (see page <a href="#">92</a> ).	14																														
	Panel PID	Panel PID macro (see page <a href="#">94</a> ).	15																														

## 418 Parameters

No.	Name/Value	Description	Def/FbEq16
	PFC	PFC macro (see page 96).	16
	ABB standard (vector)	ABB standard (vector) macro (see page 80). For vector motor control.	17
	Torque control	Torque control macro see (page 98).	28
96.05	<i>Macro active</i>	Shows which control macro is currently selected. See chapter <a href="#">Control macros</a> (page 77) for more information. To change the macro, use parameter <a href="#">96.04 Macro select</a> .	<i>ABB standard</i>
	ABB standard	Factory macro (see page 78). For scalar motor control.	1
	Hand/Auto	Hand/Auto macro (see page 88).	2
	Hand/PID	Hand/PID macro (see page 90).	3
	3-wire	3-wire macro see page 78).	11
	Alternate	Alternate macro see page 84).	12
	Motor potentiometer	Motor potentiometer macro (see page 86).	13
	PID	PID macro (see page 92).	14
	Panel PID	Panel PID macro (see page 94).	15
	PFC	PFC macro (see page 96).	16
	ABB standard (vector)	ABB standard (vector) macro (see page 80). For vector motor control.	17
	Torque control	Torque control macro (page 98).	28
96.06	<i>Parameter restore</i>	Restores the original settings of the control program, ie. parameter default values. <b>Note:</b> This parameter cannot be changed while the drive is running.	<i>Done</i>
	Done	Restoring is completed.	0
	Restore defaults	Restores all editable parameter values to default values, except <ul style="list-style-type: none"> <li>• motor data and ID run results</li> <li>• I/O extension module settings</li> <li>• end user texts, such as customized warnings and faults, and the drive name</li> <li>• control panel/PC communication settings</li> <li>• fieldbus adapter settings</li> <li>• control macro selection and the parameter defaults</li> <li>• <a href="#">parameter 95.01 Supply voltage</a></li> <li>• differentiated defaults implemented by parameters <a href="#">95.20 HW options word 1</a> and <a href="#">95.21 HW options word 2</a></li> <li>• user lock configuration parameters <a href="#">96.100...96.102</a>.</li> </ul>	8
	Clear all	Restores all editable parameter values to default values, except <ul style="list-style-type: none"> <li>• end user texts, such as customized warnings and faults, and the drive name</li> <li>• control panel/PC communication settings</li> <li>• control macro selection and the parameter defaults</li> <li>• <a href="#">parameter 95.01 Supply voltage</a></li> <li>• differentiated defaults implemented by parameters <a href="#">95.20 HW options word 1</a> and <a href="#">95.21 HW options word 2</a></li> <li>• user lock configuration parameters <a href="#">96.100...96.102</a>.</li> <li>• group <a href="#">49 Panel port communication</a> parameters.</li> </ul>	62

No.	Name/Value	Description	Def/FbEq16
	Reset all fieldbus settings	Restores all fieldbus and communication related settings to default values. <b>Note:</b> Fieldbus, control panel and PC tool communication are interrupted during the restore.	32
	Reset home view	Restores the Home view layout back to show the values of the default parameters defined by the control macro in use	512
	Reset end user texts	Restores all end user texts to default values, including the drive name, contact info, customized fault and warning texts, PID unit and currency unit. <b>Note:</b> PID unit is reset only if it is user editable text, that is, parameter <a href="#">40.79 Set 1 units</a> is set to <i>User text</i> .	1024
	Reset motor data	Restores all motor nominal values and motor ID run results to default values.	2
	All to factory defaults	Restores settings and all editable parameters back to initial factory values, except <ul style="list-style-type: none"> <li>differentiated defaults implemented by parameters <a href="#">95.20 HW options word 1</a> and <a href="#">95.21 HW options word 2</a>.</li> </ul>	34560
<a href="#">96.07</a>	<a href="#">Parameter save manually</a>	Saves the valid parameter values to the permanent memory on the drive control unit to ensure that operation can continue after cycling the power. Save the parameters with this parameter <ul style="list-style-type: none"> <li>to store values sent from the fieldbus</li> <li>when using external +24 V DC power supply to the control unit: to save parameter changes before you power down the control unit. The supply has a very short hold-up time when powered off.</li> </ul> <b>Note:</b> A new parameter value is saved automatically when changed from the PC tool or control panel but not when altered through a fieldbus adapter connection.	<i>Done</i>
	Done	Save completed.	0
	Save	Save in progress.	1
<a href="#">96.08</a>	<a href="#">Control board boot</a>	Changing the value of this parameter to 1 reboots the control unit (without requiring a power off/on cycle of the complete drive module). The value reverts to 0 automatically.	<i>No action</i>
	No action	1 = No action.	0
	Reboot	1 = Reboot the control unit.	1
<a href="#">96.10</a>	<a href="#">User set status</a>	Shows the status of the user parameter sets. This parameter is read-only. See also section <a href="#">User parameter sets</a> (page 190).	<i>n/a</i>
	n/a	No user parameter sets have been saved.	0
	Loading	A user set is being loaded.	1
	Saving	A user set is being saved.	2
	Faulted	Invalid or empty parameter set.	3
	User1 IO active	User set 1 has been selected by parameters <a href="#">96.12 User set I/O mode in1</a> and <a href="#">96.13 User set I/O mode in2</a> .	4
	User2 IO active	User set 2 has been selected by parameters <a href="#">96.12 User set I/O mode in1</a> and <a href="#">96.13 User set I/O mode in2</a> .	5
	User3 IO active	User set 3 has been selected by parameters <a href="#">96.12 User set I/O mode in1</a> and <a href="#">96.13 User set I/O mode in2</a> .	6

## 420 Parameters

No.	Name/Value	Description	Def/FbEq16															
	User4 IO active	User set 4 has been selected by parameters <a href="#">96.12 User set I/O mode in1</a> and <a href="#">96.13 User set I/O mode in2</a> .	7															
	Reserved		8...19															
	User1 backup	User set 1 has been saved or loaded.	20															
	User2 backup	User set 2 has been saved or loaded.	21															
	User3 backup	User set 3 has been saved or loaded.	22															
	User4 backup	User set 4 has been saved or loaded.	23															
<a href="#">96.11</a>	<a href="#">User set save/load</a>	<p>Enables the saving and restoring of up to four custom sets of parameter settings.</p> <p>The set that was in use before powering down the drive is in use after the next power-up.</p> <p><b>Notes:</b></p> <ul style="list-style-type: none"> <li>Some hardware configuration settings, such as I/O extension module and fieldbus configuration parameters (groups 14...16, 47, 50...58 and 92...93) are not included in user parameter sets.</li> <li>Parameter changes made after loading a set are not automatically stored – they must be saved using this parameter.</li> <li>This parameter cannot be changed while the drive is running</li> </ul>	<i>No action</i>															
	No action	Load or save operation complete; normal operation.	0															
	User set I/O mode	Load user parameter set using parameters <a href="#">96.12 User set I/O mode in1</a> and <a href="#">96.13 User set I/O mode in2</a> .	1															
	Load set 1	Load user parameter set 1.	2															
	Load set 2	Load user parameter set 2.	3															
	Load set 3	Load user parameter set 3.	4															
	Load set 4	Load user parameter set 4.	5															
	Reserved		6...17															
	Save to set 1	Save user parameter set 1.	18															
	Save to set 2	Save user parameter set 2.	19															
	Save to set 3	Save user parameter set 3.	20															
	Save to set 4	Save user parameter set 4.	21															
<a href="#">96.12</a>	<a href="#">User set I/O mode in1</a>	<p>When parameter <a href="#">96.11 User set save/load</a> is set to <i>User set I/O mode</i>, selects the user parameter set together with parameter <a href="#">96.13 User set I/O mode in2</a> as follows:</p> <table border="1" data-bbox="342 1161 850 1382"> <thead> <tr> <th>Status of source defined by par. <a href="#">96.12</a></th> <th>Status of source defined by par. <a href="#">96.13</a></th> <th>User parameter set selected</th> </tr> </thead> <tbody> <tr> <td>0</td> <td>0</td> <td>Set 1</td> </tr> <tr> <td>1</td> <td>0</td> <td>Set 2</td> </tr> <tr> <td>0</td> <td>1</td> <td>Set 3</td> </tr> <tr> <td>1</td> <td>1</td> <td>Set 4</td> </tr> </tbody> </table>	Status of source defined by par. <a href="#">96.12</a>	Status of source defined by par. <a href="#">96.13</a>	User parameter set selected	0	0	Set 1	1	0	Set 2	0	1	Set 3	1	1	Set 4	<i>Not selected</i>
Status of source defined by par. <a href="#">96.12</a>	Status of source defined by par. <a href="#">96.13</a>	User parameter set selected																
0	0	Set 1																
1	0	Set 2																
0	1	Set 3																
1	1	Set 4																
	Not selected	0.	0															
	Selected	1.	1															

No.	Name/Value	Description	Def/FbEq16																								
	DI1	Digital input DI1 ( <a href="#">10.02 DI delayed status</a> , bit 0).	2																								
	DI2	Digital input DI2 ( <a href="#">10.02 DI delayed status</a> , bit 1).	3																								
	DI3	Digital input DI3 ( <a href="#">10.02 DI delayed status</a> , bit 2).	4																								
	DI4	Digital input DI4 ( <a href="#">10.02 DI delayed status</a> , bit 3).	5																								
	DI5	Digital input DI5 ( <a href="#">10.02 DI delayed status</a> , bit 4).	6																								
	DI6	Digital input DI6 ( <a href="#">10.02 DI delayed status</a> , bit 5).	7																								
	Reserved		8...17																								
	Timed function 1	Bit 0 of <a href="#">34.01 Timed functions status</a> (see page <a href="#">327</a> ).	18																								
	Timed function 2	Bit 1 of <a href="#">34.01 Timed functions status</a> (see page <a href="#">327</a> ).	19																								
	Timed function 3	Bit 2 of <a href="#">34.01 Timed functions status</a> (see page <a href="#">327</a> ).	20																								
	Reserved		21...23																								
	Supervision 1	Bit 0 of <a href="#">32.01 Supervision status</a> (see page <a href="#">319</a> ).	24																								
	Supervision 2	Bit 1 of <a href="#">32.01 Supervision status</a> (see page <a href="#">319</a> ).	25																								
	Supervision 3	Bit 2 of <a href="#">32.01 Supervision status</a> (see page <a href="#">319</a> ).	26																								
	<i>Other [bit]</i>	Source selection (see <a href="#">Terms and abbreviations</a> on page <a href="#">196</a> ).	-																								
<a href="#">96.13</a>	<a href="#">User set I/O mode in2</a>	See parameter <a href="#">96.12 User set I/O mode in1</a> .	<i>Not selected</i>																								
<a href="#">96.16</a>	<a href="#">Unit selection</a>	Selects the unit of parameters indicating power, temperature and torque.	0000h																								
		<table border="1"> <thead> <tr> <th>Bit</th> <th>Name</th> <th>Information</th> </tr> </thead> <tbody> <tr> <td rowspan="2">0</td> <td rowspan="2">Power unit</td> <td>0 = kW</td> </tr> <tr> <td>1 = hp</td> </tr> <tr> <td>1</td> <td>Reserved</td> <td></td> </tr> <tr> <td rowspan="2">2</td> <td rowspan="2">Temperature unit</td> <td>0 = °C</td> </tr> <tr> <td>1 = °F</td> </tr> <tr> <td>3</td> <td>Reserved</td> <td></td> </tr> <tr> <td rowspan="2">4</td> <td rowspan="2">Torque unit</td> <td>0 = Nm (N·m)</td> </tr> <tr> <td>1 = lbft (lb·ft)</td> </tr> <tr> <td>5...15</td> <td>Reserved</td> <td></td> </tr> </tbody> </table>	Bit	Name	Information	0	Power unit	0 = kW	1 = hp	1	Reserved		2	Temperature unit	0 = °C	1 = °F	3	Reserved		4	Torque unit	0 = Nm (N·m)	1 = lbft (lb·ft)	5...15	Reserved		
Bit	Name	Information																									
0	Power unit	0 = kW																									
		1 = hp																									
1	Reserved																										
2	Temperature unit	0 = °C																									
		1 = °F																									
3	Reserved																										
4	Torque unit	0 = Nm (N·m)																									
		1 = lbft (lb·ft)																									
5...15	Reserved																										
	0000h...FFFFh	Unit selection word.	1 = 1																								
<a href="#">96.20</a>	<a href="#">Time sync primary source</a>	Defines the first priority external source for synchronization of the drive's time and date.	<a href="#">Panel link</a>																								
	Internal	No external source selected.	0																								
	Fieldbus A	FENA/FPNO can get the time from SNTP server and set it as the time for the drive.	3																								
	Embedded FB	Embedded fieldbus has no function.	6																								
	Panel link	You can set the time using control panel, or Drive composer PC tool connected to the control panel.	8																								
	Ethernet tool link	You can set the time manually using DCP over Ethernet. The time can be set in the same way when you do it with USB and control panel.	9																								

## 422 Parameters

No.	Name/Value	Description	Def/FbEq16																											
96.51	<i>Clear fault and event logger</i>	Clears all events from the drive's fault and event logs.	<i>Done</i>																											
	Done	0 = No action.	0																											
	Reset	1 = Resets (clears) the loggers.	1																											
96.54	<i>Checksum action</i>	<p>Selects how the drive reacts.</p> <ul style="list-style-type: none"> <li>when <a href="#">96.55 Checksum control word</a>, bit 8 = 1 (Approved checksum A): if the parameter checksum <a href="#">96.68 Actual checksumA</a> does not match <a href="#">96.71 Approved checksum A</a>, and/or</li> <li>when <a href="#">96.55 Checksum control word</a>, bit 9 = 1 (Approved checksum B): if the parameter checksum <a href="#">96.69 Actual checksumB</a> does not match <a href="#">96.72 Approved checksum B</a>.</li> </ul>	<i>No action</i>																											
	No action	No action taken. (The checksum feature is not in use.)	0																											
	Pure event	The drive generates an event log entry ( <a href="#">B686 Checksum mismatch</a> ).	1																											
	Warning	The drive generates a warning ( <a href="#">A686 Checksum mismatch</a> ).	2																											
	Warning and prevent start	The drive generates a warning ( <a href="#">A686 Checksum mismatch</a> ). Starting the drive is prevented.	3																											
	Fault	The drive trips on <a href="#">6200 Checksum mismatch</a> .	4																											
96.55	<i>Checksum control word</i>	<p>Bits 8...9 select which comparison(s) are made:</p> <ul style="list-style-type: none"> <li>Bit 8 = 1 (Approved checksum A): <a href="#">96.68 Actual checksumA</a> is compared to <a href="#">96.71 Approved checksum A</a>, and/or</li> <li>Bit 9 = 1 (Approved checksum A): if <a href="#">96.69 Actual checksumB</a> is compared to <a href="#">96.72 Approved checksum B</a>.</li> </ul> <p>Bits 12...13 select approved (reference) checksum parameter(s) into which the actual checksum(s) from parameter(s) are copied:</p> <ul style="list-style-type: none"> <li>Bit 12 = 1 (Set approved checksum A): Value of <a href="#">96.68 Actual checksumA</a> is copied into <a href="#">96.71 Approved checksum A</a>, and/or</li> <li>Bit 13 = 1 (Set approved checksum B): Value of <a href="#">96.69 Actual checksumB</a> copied into <a href="#">96.72 Approved checksum B</a>.</li> </ul>	0000000h																											
<table border="1"> <thead> <tr> <th>Bit</th> <th>Name</th> <th>Information</th> </tr> </thead> <tbody> <tr> <td>0...7</td> <td>Reserved</td> <td></td> </tr> <tr> <td>8</td> <td>Approved checksum A</td> <td>1 = Enabled: Checksum A (<a href="#">96.71</a>) is observed. 0 = Disabled.</td> </tr> <tr> <td>9</td> <td>Approved checksum B</td> <td>1 = Enabled: Checksum B (<a href="#">96.72</a>) is observed. 0 = Disabled.</td> </tr> <tr> <td>10...11</td> <td>Reserved</td> <td></td> </tr> <tr> <td>12</td> <td>Set approved checksum A</td> <td>1 = Set: Copy value of <a href="#">96.68</a> into <a href="#">96.71</a>. 0 = Done (copy has been made).</td> </tr> <tr> <td>13</td> <td>Set approved checksum B</td> <td>1 = Set: Copy value of <a href="#">96.69</a> into <a href="#">96.72</a>. 0 = Done (copy has been made).</td> </tr> <tr> <td></td> <td></td> <td>1 = lbft (lb-ft)</td> </tr> <tr> <td>14...15</td> <td>Reserved</td> <td></td> </tr> </tbody> </table>				Bit	Name	Information	0...7	Reserved		8	Approved checksum A	1 = Enabled: Checksum A ( <a href="#">96.71</a> ) is observed. 0 = Disabled.	9	Approved checksum B	1 = Enabled: Checksum B ( <a href="#">96.72</a> ) is observed. 0 = Disabled.	10...11	Reserved		12	Set approved checksum A	1 = Set: Copy value of <a href="#">96.68</a> into <a href="#">96.71</a> . 0 = Done (copy has been made).	13	Set approved checksum B	1 = Set: Copy value of <a href="#">96.69</a> into <a href="#">96.72</a> . 0 = Done (copy has been made).			1 = lbft (lb-ft)	14...15	Reserved	
Bit	Name	Information																												
0...7	Reserved																													
8	Approved checksum A	1 = Enabled: Checksum A ( <a href="#">96.71</a> ) is observed. 0 = Disabled.																												
9	Approved checksum B	1 = Enabled: Checksum B ( <a href="#">96.72</a> ) is observed. 0 = Disabled.																												
10...11	Reserved																													
12	Set approved checksum A	1 = Set: Copy value of <a href="#">96.68</a> into <a href="#">96.71</a> . 0 = Done (copy has been made).																												
13	Set approved checksum B	1 = Set: Copy value of <a href="#">96.69</a> into <a href="#">96.72</a> . 0 = Done (copy has been made).																												
		1 = lbft (lb-ft)																												
14...15	Reserved																													
	00000000... FFFFFFFh	Checksum control word.	1 = 1																											

No.	Name/Value	Description	Def/FbEq16
96.68	<a href="#">Actual checksumA</a>	Displays the actual parameter configuration checksum A. The checksum A is generated and updated whenever an action is selected in <a href="#">96.54 Checksum action</a> and <a href="#">96.55 Checksum control word</a> , bit 8 = 1 (Approved checksum A). Checksum A calculation does not include <ul style="list-style-type: none"> <li>• fieldbus settings.</li> </ul> The parameters included in the calculation are user editable parameters in parameter groups 10, 11, 12, 13, 15, 19, 20, 21, 22, 23, 24, 25, 28, 30, 31, 32, 34, 35, 36, 37, 40, 41, 43, 45, 46, 70, 71, 72, 73, 74, 76, 80, 94, 95, 96, 97, 98, 99. See also section <a href="#">Parameter checksum calculation</a> (page 191).	0h
	00000000... FFFFFFFFh	Actual checksum.	-
96.69	<a href="#">Actual checksumB</a>	Displays the actual parameter configuration checksum B. The checksum B is generated and updated whenever an action is selected in <a href="#">96.54 Checksum action</a> and <a href="#">96.55 Checksum control word</a> , bit 9 = 1 (Approved checksum B). Checksum B calculation does not include <ul style="list-style-type: none"> <li>• fieldbus settings</li> <li>• motor data settings</li> <li>• energy data settings.</li> </ul> The parameters included in the calculation are user editable parameters in parameter groups 10, 11, 12, 13, 15, 19, 20, 21, 22, 23, 24, 25, 28, 30, 31, 32, 34, 35, 36, 37, 40, 41, 43, 46, 70, 71, 72, 73, 74, 76, 80, 94, 95, 96, 97. See also section <a href="#">Parameter checksum calculation</a> (page 191).	0h
	00000000h... FFFFFFFFh	Actual checksum.	-
96.70	<a href="#">Disable adaptive program</a>	Enables/disables the adaptive program (if present). See also section <a href="#">Adaptive programming</a> (page 117).	Yes
	No	Adaptive program enabled.	0
	Yes	Adaptive program disabled.	1
96.71	<a href="#">Approved checksum A</a>	Approved (reference) checksum A.	0h
	00000000h... FFFFFFFFh	Approved checksum A.	-
96.72	<a href="#">Approved checksum B</a>	Approved (reference) checksum B.	0h
	00000000h... FFFFFFFFh	Approved checksum B.	-
96.78	<a href="#">550 compatibility mode</a>	Enables/disables a Modbus user to access a select set of parameters using 550 register numbering. See the supported parameters in section <a href="#">Parameters supported by Modbus backwards compatibility with 550</a> on page 439.	Disable
	Disable	Using 550 compatibility mode is disabled.	0
	Enable	Using 550 compatibility mode is enabled.	1

No.	Name/Value	Description	Def/FbEq16
96.100	<a href="#">Change user pass code</a>	<i>(Visible when user lock is open)</i> To change the current user pass code, enter a new code into this parameter as well as <a href="#">96.101 Confirm user pass code</a> . A warning will be active until the new pass code is confirmed. To cancel changing the pass code, close the user lock without confirming. To close the lock, enter an invalid pass code in parameter <a href="#">96.02 Pass code</a> , activate parameter <a href="#">96.08 Control board boot</a> , or cycle the power. See also section <a href="#">User lock</a> (page 192).	10000000
	10000000... 99999999	New user pass code.	-
96.101	<a href="#">Confirm user pass code</a>	<i>(Visible when user lock is open)</i> Confirms the new user pass code entered in <a href="#">96.100 Change user pass code</a> .	
	10000000... 99999999	Confirmation of new user pass code.	-
96.102	<a href="#">User lock functionality</a>	<i>(Visible when user lock is open)</i> Selects the actions or functionalities to be prevented by the user lock. Note that the changes made take effect only when the user lock is closed. See parameter <a href="#">96.02 Pass code</a> . <b>Note:</b> ABB recommends you select all the actions and functionalities unless otherwise required by the application.	0000h

Bit	Name	Information
0	Disable ABB access levels	1 = ABB access levels (service, advanced programmer, etc.; see <a href="#">96.03</a> ) disabled
1	Freeze parameter lock state	1 = Changing the parameter lock state prevented, ie. pass code 358 has no effect
2	Disable file download	1 = Loading of files to drive prevented. This applies to <ul style="list-style-type: none"> <li>• firmware upgrades</li> <li>• parameter restore</li> <li>• loading an adaptive program</li> <li>• changing Home view of control panel</li> <li>• editing drive texts</li> <li>• editing the favorite parameters list on control panel</li> <li>• configuration settings made through control panel such as time/date formats and enabling/disabling clock display.</li> </ul>
3...10	Reserved	
11	Disable OEM access level 1	1 = OEM access level 1 disabled
12	Disable OEM access level 2	1 = OEM access level 2 disabled
13	Disable OEM access level 3	1 = OEM access level 3 disabled
14...15	Reserved	

  

0000h...FFFFh	Selection of actions to be prevented by user lock.	-
---------------	--	---



No.	Name/Value	Description	Def/FbEq16
<b>97 Motor control</b>		Switching frequency; slip gain; voltage reserve; flux braking; anti-cogging (signal injection); IR compensation.	
97.01	<i>Switching frequency reference</i>	<p>Defines the switching frequency of the drive that is used as long as the drive stays below the thermal limit. See section <a href="#">Switching frequency</a> on page 164.</p> <p>Higher switching frequency results in lower acoustic motor noise. Lower switching frequency generates less switching losses and reduce EMC emissions.</p> <p><b>Notes:</b></p> <ul style="list-style-type: none"> <li>• If you have a multimotor system, contact your local ABB representative.</li> <li>• With the CPTC-02 ATEX-certified thermistor protection module, follow the instructions given in the <i>CPTC-02 ATEX-certified thermistor protection module, Ex II (2) GD (+L537+Q971) user's manual (3AXD5000030058 [English])</i>.</li> <li>• With an ABB EX motor, follow the instructions given in the ABB EX motor documentation.</li> </ul>	4 kHz
	2 kHz	2 kHz.	2
	4 kHz	4 kHz.	4
	8 kHz	8 kHz.	8
	12 kHz	12 kHz.	12
97.02	<i>Minimum switching frequency</i>	<p>Lowest switching frequency value that is allowed. Depends on the frame size.</p> <p>When drive is reaching the thermal limit, it will automatically start to reduce the switching frequency until the minimum allowed value is reached. Once the minimum has been reached, the drive will automatically start limiting the output current to keep the temperature below the thermal limit. Inverter temperature is shown by parameter <a href="#">05.11 Inverter temperature</a>.</p> <p><b>Notes:</b></p> <ul style="list-style-type: none"> <li>• With the CPTC-02 ATEX-certified thermistor protection module, follow the instructions given in the <i>CPTC-02 ATEX-certified thermistor protection module, Ex II (2) GD (+L537+Q971) user's manual (3AXD5000030058 [English])</i>.</li> <li>• With an ABB EX motor, follow the instructions given in the ABB EX motor documentation.</li> </ul>	1.5 kHz
	1.5 kHz	1.5 kHz. Not for all frame sizes.	1
	2 kHz	2 kHz.	2
	4 kHz	4 kHz.	4
	8 kHz	8 kHz.	8
	12 kHz	12 kHz.	12

## 426 Parameters

No.	Name/Value	Description	Def/FbEq16
97.03	<i>Slip gain</i>	<p>Defines the slip gain which is used to improve the estimated motor slip. 100% means full slip gain; 0% means no slip gain. The default value is 100%. Other values can be used if a static speed error is detected despite having the setting at full slip gain.</p> <p><b>Example</b> (with nominal load and nominal slip of 40 rpm): A 1000 rpm constant speed reference is given to the drive. Despite having full slip gain (= 100%), a manual tachometer measurement from the motor axis gives a speed value of 998 rpm. The static speed error is 1000 rpm - 998 rpm = 2 rpm. To compensate the error, the slip gain should be increased to 105% (2 rpm / 40 rpm = 5%).</p>	100%
	0...200%	Slip gain.	1 = 1%
97.04	<i>Voltage reserve</i>	<p>Defines the minimum allowed voltage reserve. When the voltage reserve has decreased to the set value, the drive enters the field weakening area.</p> <p><b>Note:</b> This is an expert level parameter and should not be adjusted without appropriate skill.</p> <p>If the intermediate circuit DC voltage <math>U_{dc} = 550</math> V and the voltage reserve is 5%, the RMS value of the maximum output voltage in steady-state operation is <math>0.95 \times 550</math> V / <math>\sqrt{2} = 369</math> V</p> <p>The dynamic performance of the motor control in the field weakening area can be improved by increasing the voltage reserve value, but the drive enters the field weakening area earlier.</p>	-2%
	-4...50%	Voltage reserve.	1 = 1%
97.05	<i>Flux braking</i>	<p>Defines the level of flux braking power. (Other stopping and braking modes can be configured in parameter group <a href="#">21 Start/stop mode</a>).</p> <p><b>Note:</b> This is an expert level parameter and should not be adjusted without appropriate skill.</p>	<i>Disabled</i>
	Disabled	Flux braking is disabled.	0
	Moderate	Flux level is limited during the braking. Deceleration time is longer compared to full braking.	1
	Full	<p>Maximum braking power. Almost all available current is used to convert the mechanical braking energy to thermal energy in the motor.</p> <p> <b>WARNING!</b> Using full flux braking heats up the motor especially in cyclic operation. Make sure that the motor can withstand this if you have a cyclic application.</p>	2
97.08	<i>Optimizer minimum torque</i>	<p>This parameter can be used to improve the control dynamics of a synchronous reluctance motor or a salient permanent magnet synchronous motor.</p> <p>As a rule of thumb, define a level to which the output torque must rise with minimum delay. This will increase the motor current and improve the torque response at low speeds.</p>	0.0%
	0.0 ... 1600.0%	Optimizer torque limit.	10 = 1%

No.	Name/Value	Description	Def/FbEq16
97.10	<i>Signal injection</i>	<p>Enables the anti-cogging function: a high-frequency alternating signal is injected to the motor in the low speed region to improve the stability of torque control. This removes the "cogging" that can sometimes be seen as the rotor passes the motor magnetic poles. Anti-cogging can be enabled with different amplitude levels.</p> <p><b>Notes:</b></p> <ul style="list-style-type: none"> <li>• This is an expert level parameter and should not be adjusted without appropriate skill.</li> <li>• Use as low a level as possible that gives satisfactory performance.</li> <li>• Signal injection cannot be applied to asynchronous motors.</li> <li>• For frames R6...R9 only.</li> </ul>	<i>Disabled</i>
	Disabled	Anti-cogging disabled.	0
	Enabled (5%)	Anti-cogging enabled with amplitude level of 5%.	1
	Enabled (10%)	Anti-cogging enabled with amplitude level of 10%.	2
	Enabled (15%)	Anti-cogging enabled with amplitude level of 15%.	3
	Enabled (20%)	Anti-cogging enabled with amplitude level of 20%.	4
97.11	<i>TR tuning</i>	<p>Rotor time constant tuning.</p> <p>This parameter can be used to improve torque accuracy in closed-loop control of an induction motor. Normally, the motor identification run provides sufficient torque accuracy, but manual fine-tuning can be applied in exceptionally demanding applications to achieve optimal performance.</p> <p><b>Note:</b> This is an expert level parameter and should not be adjusted without appropriate skill.</p>	100%
	25...400%	Rotor time constant tuning.	1 = 1%

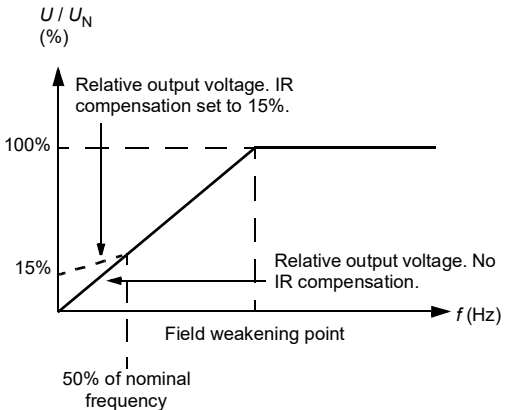
No.	Name/Value	Description	Def/FbEq16																		
97.13	<i>IR compensation</i>	<p>Defines the relative output voltage boost at zero speed (IR compensation). The function is useful in applications with a high break-away torque where vector control cannot be applied.</p>  <p>See also section <i>IR compensation for scalar motor control</i> on page 157. Typical IR compensation values are shown below.</p> <table border="1" data-bbox="340 767 844 852"> <thead> <tr> <th colspan="6">3-phase <math>U_N = 400\text{ V}</math> (380...415 V) drives</th> </tr> </thead> <tbody> <tr> <td><math>P_N</math> (kW)</td> <td>3</td> <td>7.5</td> <td>15</td> <td>37</td> <td>132</td> </tr> <tr> <td>IR compensation (%)</td> <td>2.5</td> <td>1.7</td> <td>1.3</td> <td>1.1</td> <td>0.6</td> </tr> </tbody> </table>	3-phase $U_N = 400\text{ V}$ (380...415 V) drives						$P_N$ (kW)	3	7.5	15	37	132	IR compensation (%)	2.5	1.7	1.3	1.1	0.6	Type specific (%)
3-phase $U_N = 400\text{ V}$ (380...415 V) drives																					
$P_N$ (kW)	3	7.5	15	37	132																
IR compensation (%)	2.5	1.7	1.3	1.1	0.6																
	0.00...50.00%	Voltage boost at zero speed in percent of nominal motor voltage.	1 = 1%																		
97.15	<i>Motor model temperature adaptation</i>	Enables the motor model temperature adaptation. Estimated motor temperature can be used to adapt temperature dependent parameters (for example, resistances) of motor model.	<i>Disabled</i>																		
	Disabled	Temperature adaptation disabled.	0																		
	Estimated temperature	Temperature adaptation with motor temperature estimate (parameter <i>35.01 Motor estimated temperature</i> ).	1																		
97.16	<i>Stator temperature factor</i>	Tunes the motor temperature dependence of stator parameters (stator resistance).	50%																		
	0...200%	Tuning factor.	1 = 1%																		
97.17	<i>Rotor temperature factor</i>	Tunes the motor temperature dependence of rotor parameters (for example, rotor resistance).	100%																		
	0...200%	Tuning factor.	1 = 1%																		
97.20	<i>U/f ratio</i>	<p>Selects the form for the <i>U/f</i> (voltage to frequency) ratio below field weakening point. For scalar control only.</p> <p><b>Note:</b> The <i>U/f</i> function cannot be used with energy optimization; if <i>45.11 Energy optimizer</i> is set to <i>Enable</i>, parameter <i>97.20 U/f ratio</i> is ignored.</p>	<i>Linear</i>																		
	Linear	Linear ratio for constant torque applications.	0																		

No.	Name/Value	Description	Def/FbEq16
	Squared	Squared ratio for centrifugal pump and fan applications. With squared U/f ratio the noise level is lower for most operating frequencies. Not recommended for permanent magnet motors.	1
97.48	<i>Udc stabilizer</i>	Enables or disables the DC bus voltage stabilizer.	<i>Disabled</i>
	Disabled	DC bus voltage stabilizer disabled.	0
	Enabled min	DC bus voltage stabilizer enabled, minimum stabilization.	50
	Enabled mild	DC bus voltage stabilizer enabled, mild stabilization.	100
	Enabled medium	DC bus voltage stabilizer enabled, medium stabilization.	300
	Enabled strong	DC bus voltage stabilizer enabled, strong stabilization.	500
	Enabled max	DC bus voltage stabilizer enabled, maximum stabilization.	800
97.49	<i>Slip gain for scalar</i>	Sets gain for slip compensation in percent when the drive is operating in scalar control mode. A squirrel-cage motor slips under load. Increasing the frequency as the motor torque increases compensates for the slip. <b>Note:</b> This parameter is only effective in scalar motor control mode (parameter <i>99.04 Motor control mode</i> is set to <i>Scalar</i> ).	0%
	0...200%	0% = No slip compensation. 0...200% = Increasing slip compensation. 100% means full slip compensation according to parameter <i>99.08 Motor nominal frequency</i> and <i>99.09 Motor nominal speed</i> .	1 = 1%
97.94	<i>IR comp max frequency</i>	Sets the frequency at which IR compensation set by parameter <i>97.13 IR compensation</i> reaches 0 V. Unit is percent of the motor nominal frequency.	50.0%
	1.0...200.0%	Frequency.	1 = 1%
97.135	<i>Udc ripple</i>	Calculates ripple voltage.	0.0 V
	0.0...200.0 V	Voltage.	1 = 1 V

<b>98 User motor parameters</b>		Motor values supplied by the user that are used in the motor model. These parameters are useful for non-standard motors, or to just get more accurate motor control of the motor on site. A better motor model always improves the shaft performance.	
98.01	<i>User motor model mode</i>	Activates the motor model parameters <i>98.02...98.12</i> and <i>98.14</i> . <b>Notes:</b> <ul style="list-style-type: none"> <li>Parameter value is automatically set to zero when ID run is selected by parameter <i>99.13 ID run requested</i>. The values of parameters <i>98.02...98.12</i> are then updated according to the motor characteristics identified during the ID run.</li> <li>Measurements made directly from the motor terminals during the ID run are likely to produce slightly different values than those on a data sheet from a motor manufacturer.</li> <li>This parameter cannot be changed while the drive is running.</li> </ul>	<i>Not selected</i>
	Not selected	Parameters <i>98.02...98.12</i> inactive.	0
	Motor parameters	The values of parameters <i>98.02... 98.12</i> are used as the motor model.	1

## 430 Parameters

No.	Name/Value	Description	Def/FbEq16
98.02	<i>Rs user</i>	Defines the stator resistance $R_S$ of the motor model. With a star-connected motor, $R_S$ is the resistance of one winding. With a delta-connected motor, $R_S$ is one-third of the resistance of one winding. Resistance value is given at 20 °C (68 °F).	0.00000 p.u.
	0.00000...0.50000 p.u.	Stator resistance in per unit.	-
98.03	<i>Rr user</i>	Defines the rotor resistance $R_R$ of the motor model. Resistance value is given at 20 °C (68 °F). <b>Note:</b> This parameter is valid only for asynchronous motors.	0.00000 p.u.
	0.00000...0.50000 p.u.	Rotor resistance in per unit.	-
98.04	<i>Lm user</i>	Defines the main inductance $L_M$ of the motor model. <b>Note:</b> This parameter is valid only for asynchronous motors.	0.00000 p.u.
	0.00000...10.00000 p.u.	Main inductance in per unit.	-
98.05	<i>SigmaL user</i>	Defines the leakage inductance $\sigma L_S$ . <b>Note:</b> This parameter is valid only for asynchronous motors.	0.00000 p.u.
	0.00000...1.00000 p.u.	Leakage inductance in per unit.	-
98.06	<i>Ld user</i>	Defines the direct axis (synchronous) inductance. <b>Note:</b> This parameter is valid only for permanent magnet motors.	0.00000 p.u.
	0.00000...10.00000 p.u	Direct axis inductance in per unit.	-
98.07	<i>Lq user</i>	Defines the quadrature axis (synchronous) inductance. <b>Note:</b> This parameter is valid only for permanent magnet motors.	0.00000 p.u.
	0.00000...10.00000 p.u	Quadrature axis inductance in per unit.	-
98.08	<i>PM flux user</i>	Defines the permanent magnet flux. <b>Note:</b> This parameter is valid only for permanent magnet motors.	0.00000 p.u.
	0.00000... 2.00000 p.u	Permanent magnet flux in per unit.	-
98.09	<i>Rs user SI</i>	Defines the stator resistance $R_S$ of the motor model. Resistance value is given at 20 °C (68 °F).	0.00000 ohm
	0.00000... 100.00000 ohm	Stator resistance.	-
98.10	<i>Rr user SI</i>	Defines the rotor resistance $R_R$ of the motor model. Resistance value is given at 20 °C (68 °F). <b>Note:</b> This parameter is valid only for asynchronous motors.	0.00000 ohm
	0.00000... 100.00000 ohm	Rotor resistance.	-
98.11	<i>Lm user SI</i>	Defines the main inductance $L_M$ of the motor model. <b>Note:</b> This parameter is valid only for asynchronous motors.	0.00 mH
	0.00...100000.00 mH	Main inductance.	1 = 10000 mH



No.	Name/Value	Description	Def/FbEq16
98.12	<i>SigmaL user SI</i>	Defines the leakage inductance $\sigma L_S$ . <b>Note:</b> This parameter is valid only for asynchronous motors.	0.00 mH
	0.00...100000.00 mH	Leakage inductance.	1 = 10000 mH
98.13	<i>Ld user SI</i>	Defines the direct axis (synchronous) inductance. <b>Note:</b> This parameter is valid only for permanent magnet motors.	0.00 mH
	0.00...100000.00 mH	Direct axis inductance.	1 = 10000 mH
98.14	<i>Lq user SI</i>	Defines the quadrature axis (synchronous) inductance. <b>Note:</b> This parameter is valid only for permanent magnet motors.	0.00 mH
	0.00...100000.00 mH	Quadrature axis inductance.	1 = 10000 mH
<b>99 Motor data</b>		Motor configuration settings.	
99.03	<i>Motor type</i>	Selects the motor type. <b>Note:</b> This parameter cannot be changed while the drive is running.	<i>Asynchronous motor</i>
	Asynchronous motor	Standard squirrel cage AC induction motor (asynchronous induction motor).	0
	Permanent magnet motor	Permanent magnet motor. Three-phase AC synchronous motor with permanent magnet rotor and sinusoidal BackEMF voltage. <b>Note:</b> With permanent magnet motors special attention must be paid on setting the motor nominal values correctly in parameter group <i>99 Motor data</i> . You must use vector control. If the nominal BackEMF voltage of the motor is not available, a full ID run should be performed for improving performance.	1
	SynRM	Synchronous reluctance motor. Three-phase AC synchronous motor with salient pole rotor without permanent magnets. You must use vector control for this selection.	2
99.04	<i>Motor control mode</i>	Selects the motor control mode.	<i>Scalar</i>
	Vector	Vector control. Vector control has better accuracy than scalar control but cannot be used in all situations (see selection <i>Scalar</i> below). Requires motor identification run (ID run). See parameter <i>99.13 ID run requested</i> . <b>Notes:</b> <ul style="list-style-type: none"> <li>In vector control the drive performs a standstill ID run at the first start if ID run has not been previously performed. A new start command is required after standstill ID run.</li> <li>To achieve a better motor control performance, you can perform a normal ID run without load.</li> </ul> See also section <i>Operating modes of the drive</i> (page 112).	0

No.	Name/Value	Description	Def/FbEq16
	Scalar	<p>Scalar control. Suitable for most applications, if top performance is not required.</p> <p>Motor identification run is not required.</p> <p><b>Note:</b> Scalar control must be used in the following situations:</p> <ul style="list-style-type: none"> <li>with multimotor systems 1) if the load is not equally shared between the motors, 2) if the motors are of different sizes, or 3) if the motors are going to be changed after the motor identification (ID run)</li> <li>if the nominal current of the motor is less than 1/6 of the nominal output current of the drive (Note: However, when using flying start mode in scalar control, the nominal current must be above 1/6 of the nominal output current of the drive, see parameter <a href="#">21.19 Scalar start mode</a>, selection Flying start.)</li> <li>if the drive is used with no motor connected (for example, for test purposes).</li> </ul> <p><b>Note:</b> Correct motor operation requires that the magnetizing current of the motor does not exceed 90% of the nominal current of the inverter.</p> <p>See also section <a href="#">Speed compensated stop</a> (page 168), and section <a href="#">Operating modes of the drive</a> (page 112).</p>	1
99.06	<a href="#">Motor nominal current</a>	<p>Defines the nominal motor current. Must be equal to the value on the motor rating plate. If multiple motors are connected to the drive, enter the total current of the motors.</p> <p><b>Notes:</b></p> <ul style="list-style-type: none"> <li>Correct motor operation requires that the magnetizing current of the motor does not exceed 90% of the nominal current of the drive.</li> <li>This parameter cannot be changed while the drive is running.</li> </ul>	0.0 A
	0.0...6400.0 A	<p>Nominal current of the motor. The allowable range:</p> <ul style="list-style-type: none"> <li>vector control mode: <math>1/6 \dots 2 \times I_N</math> of the drive</li> <li>scalar control mode: <math>0 \dots 2 \times I_N</math> with scalar control mode.</li> </ul> <p><b>Note:</b> When using flying start in scalar control mode (see parameter <a href="#">21.19 Scalar start mode</a>), the nominal current must be in the range allowed for vector control mode.</p>	1 = 1 A See <a href="#">46.05</a>
99.07	<a href="#">Motor nominal voltage</a>	<p>Defines the nominal motor voltage supplied to the motor. This setting must match the value on the rating plate of the motor.</p> <p><b>Notes:</b></p> <ul style="list-style-type: none"> <li>With permanent magnet motors, the nominal voltage is the BackEMF voltage at nominal speed of the motor. If the voltage is given as voltage per rpm, for example, 60 V per 1000 rpm, the voltage for a nominal speed of 3000 rpm is <math>3 \times 60 \text{ V} = 180 \text{ V}</math>.</li> <li>The stress on the motor insulation is always dependent on the drive supply voltage. This also applies to the case where the motor voltage rating is lower than that of the drive and the supply.</li> <li>This parameter cannot be changed while the drive is running.</li> </ul>	0.0 V
	0.0...960.0 V	Nominal voltage of the motor.	10 = 1 V
99.08	<a href="#">Motor nominal frequency</a>	<p>Defines the nominal motor frequency. This setting must match the value on the rating plate of the motor.</p> <p><b>Note:</b> This parameter cannot be changed while the drive is running.</p>	50.00 Hz
	0.00...500.00 Hz	Nominal frequency of the motor.	10 = 1 Hz



No.	Name/Value	Description	Def/FbEq16
99.09	<i>Motor nominal speed</i>	Defines the nominal motor speed. The setting must match the value on the rating plate of the motor. <b>Note:</b> This parameter cannot be changed while the drive is running.	0 rpm
	0...30000 rpm	Nominal speed of the motor.	1 = 1 rpm
99.10	<i>Motor nominal power</i>	Defines the nominal motor power. The setting must match the value on the rating plate of the motor. If multiple motors are connected to the drive, enter the total power of the motors. The unit is selected by parameter <a href="#">96.16 Unit selection</a> . <b>Note:</b> This parameter cannot be changed while the drive is running.	0.00 kW or hp;
	0.00... 10000.00 kW or 0.00... 13404.83 hp	Nominal power of the motor.	1 = 1 unit See <a href="#">46.04</a>
99.11	<i>Motor nominal cos ?</i>	Defines the cosphi of the motor for a more accurate motor model. The value is not obligatory, but is useful with an asynchronous motor, especially when performing a standstill identification run. With a permanent magnet or synchronous reluctance motor, this value is not needed. <b>Notes:</b> <ul style="list-style-type: none"> <li>Do not enter an estimated value. If you do not know the exact value, leave the parameter at zero.</li> <li>This parameter cannot be changed while the drive is running.</li> </ul>	0.00
	0.00...1.00	Cosphi of the motor.	100 = 1
99.12	<i>Motor nominal torque</i>	Defines the nominal motor shaft torque for a more accurate motor model. Not obligatory. The unit is selected by parameter <a href="#">96.16 Unit selection</a> . <b>Note:</b> This parameter cannot be changed while the drive is running.	0.000 N·m or lb·ft
	0.000...4000000.000 N·m or 0.000...2950248.597 lb·ft	Nominal motor torque.	1 = 100 unit

No.	Name/Value	Description	Def/FbEq16
99.13	<i>ID run requested</i>	<p>Selects the type of the motor identification routine (ID run) performed at the next start of the drive. During the ID run, the drive will identify the characteristics of the motor for optimum motor control.</p> <p>If no ID run has been performed yet (or if default parameter values have been restored using parameter <a href="#">96.06 Parameter restore</a>), this parameter is automatically set to <i>Standstill</i>, signifying that an ID run must be performed.</p> <p>After the ID run, the drive stops and this parameter is automatically set to <i>None</i>.</p> <p><b>Notes:</b></p> <ul style="list-style-type: none"> <li>To ensure that the ID run can work properly, the drive limits in group <a href="#">30</a> (maximum speed and minimum speed, and maximum torque and minimum torque) must be large enough (the range specified by the limits must be wide enough. If, for example, speed limits are less than the motor nominal speed, the ID run cannot be completed).</li> <li>Make sure the motor is stopped before starting the ID run.</li> <li>For the <i>Advanced</i> ID run, the machinery must always be de-coupled from the motor.</li> <li>With a permanent magnet or synchronous reluctance motor, a <i>Normal</i>, <i>Reduced</i> or <i>Standstill</i> ID run requires that the motor shaft is NOT locked and the load torque is less than 10%.</li> <li>With scalar control mode (<a href="#">99.04 Motor control mode = Scalar</a>), the ID run is not requested automatically. However, an ID run can be performed for more accurate torque estimation.</li> <li>Once the ID run is activated, it can be canceled by stopping the drive.</li> <li>The ID run must be performed every time any of the motor parameters (<a href="#">99.04</a>, <a href="#">99.06</a>...<a href="#">99.12</a>) have been changed.</li> <li>Ensure that the Safe Torque Off and emergency stop circuits (if any) are closed during the ID run.</li> <li>Mechanical brake (if present) is not opened by the logic for the ID run.</li> <li>This parameter cannot be changed while the drive is running.</li> </ul>	<i>None</i>
	None	No motor ID run is requested. This mode can be selected only if the ID run ( <i>Normal/Reduced/Standstill/Advanced</i> ) has already been performed once.	0
	Normal	<p>Normal ID run. Guarantees good control accuracy for all cases. The ID run takes about 90 seconds. This mode should be selected whenever it is possible.</p> <p><b>Notes:</b></p> <ul style="list-style-type: none"> <li>If the load torque will be higher than 20% of motor nominal torque, or if the machinery is not able to withstand the nominal torque transient during the ID run, then the driven machinery must be de-coupled from the motor during a Normal ID run.</li> <li>Check the direction of rotation of the motor before starting the ID run. During the run, the motor will rotate in the forward direction.</li> </ul> <p> <b>WARNING!</b> The motor will run at up to approximately 50...100% of the nominal speed during the ID run. ENSURE THAT IT IS SAFE TO RUN THE MOTOR BEFORE PERFORMING THE ID RUN!</p>	1

No.	Name/Value	Description	Def/FbEq16
	Reduced	<p>Reduced ID run. This mode should be selected instead of the <i>Normal</i> or <i>Advanced</i> ID Run if</p> <ul style="list-style-type: none"> <li>• mechanical losses are higher than 20% (ie. the motor cannot be de-coupled from the driven equipment), or if</li> <li>• flux reduction is not allowed while the motor is running (ie. in case of a motor with an integrated brake supplied from the motor terminals).</li> </ul> <p>With this ID run mode, the resultant motor control in the field weakening area or at high torques is not necessarily as accurate as motor control following a Normal ID run. Reduced ID run is completed faster than the Normal ID Run (&lt; 90 seconds).</p> <p><b>Note:</b> Check the direction of rotation of the motor before starting the ID run. During the run, the motor will rotate in the forward direction.</p> <p> <b>WARNING!</b> The motor will run at up to approximately 50...100% of the nominal speed during the ID run. ENSURE THAT IT IS SAFE TO RUN THE MOTOR BEFORE PERFORMING THE ID RUN!</p>	2
	Standstill	<p>Standstill ID run. The motor is injected with DC current. With an AC induction (asynchronous) motor, the motor shaft is not rotated. With a permanent magnet motor, the shaft can rotate up to half a revolution.</p> <p><b>Note:</b> This mode should be selected only if the <i>Normal</i>, <i>Reduced</i> or <i>Advanced</i> ID run is not possible due to the restrictions caused by the connected mechanics (eg. with lift or crane applications).</p>	3
	Reserved		4
	Current measurement calibration	<p>Current offset and gain measurement calibration is set to calibrate the control loops. The calibration will be performed at next start. Only for frames R6...R11.</p>	5
	Advanced	<p>Advanced ID run. Only for frames R6...R11.</p> <p>Guarantees the best possible control accuracy. The ID run takes a very long time to complete. This mode should be selected when top performance is needed across the whole operating area.</p> <p><b>Note:</b> The driven machinery must be de-coupled from the motor because of high torque and speed transients that are applied.</p> <p> <b>WARNING!</b> The motor may run at up to the maximum (positive) and minimum (negative) allowed speed during the ID run. Several accelerations and decelerations are done. The maximum torque, current and speed allowed by the limit parameters may be utilized. ENSURE THAT IT IS SAFE TO RUN THE MOTOR BEFORE PERFORMING THE ID RUN!</p>	6

No.	Name/Value	Description	Def/FbEq16
	Adaptive	Adaptive ID run. Improves the motor model accuracy during normal operation of the drive. The drive performs a Standstill ID run first. Motor parameters are then updated with better accuracy during an adaptation sequence when following user's driving profile. When the adaptation is complete, parameters <a href="#">99.14 Last ID run performed</a> changes from Standstill to Adaptive. Motor parameters are updated automatically and the user is not required to update any other parameter. <b>Notes:</b> <ul style="list-style-type: none"> <li>• For vector control only.</li> <li>• For frame sizes R1...R5 only.</li> </ul>	8
<a href="#">99.14</a>	<a href="#">Last ID run performed</a>	Shows the type of ID run that was performed last. For more information about the different modes, see the selections of parameter <a href="#">99.13 ID run requested</a> .	<i>None</i>
	None	No ID run has been performed.	0
	Normal	<i>Normal</i> ID run.	1
	Reduced	<i>Reduced</i> ID run.	2
	Standstill	<i>Standstill</i> ID run.	3
	Reserved		4
	Current measurement calibration	<i>Current measurement calibration</i> .	5
	Advanced	<i>Advanced</i> ID run.	6
<a href="#">99.15</a>	<a href="#">Motor polepairs calculated</a>	Calculated number of pole pairs in the motor.	0
	0...1000	Number of pole pairs.	1 = 1
<a href="#">99.16</a>	<a href="#">Motor phase order</a>	Switches the rotation direction of motor. This parameter can be used if the motor turns in the wrong direction (for example, because of the wrong phase order in the motor cable), and correcting the cabling is considered impractical. <b>Note:</b> <ul style="list-style-type: none"> <li>• Changing this parameter does not affect speed reference polarities, so positive speed reference will rotate the motor forward. The phase order selection just ensures that "forward" is in fact the correct direction.</li> </ul>	<i>U V W</i>
	U V W	Normal.	0
	U W V	Reversed rotation direction.	1

## Differences in the default values between 50 Hz and 60 Hz supply frequency settings

Parameter *95.20 HW options word 1 bit 0 Supply frequency 60 Hz* changes the drive parameter default values according to the supply frequency, 50 Hz or 60 Hz. The bit is set according to the market before the drive is delivered.

If you need to change from 50 Hz to 60 Hz, or vice versa, change the value of the bit and then do a complete reset to the drive. After that you have to reselect the macro to be used.

The table below shows the parameters whose default values depend on the supply frequency setting. The supply frequency setting, with the type designation of the drive, also affects Group *99 Motor data* parameter values though these parameters are not listed in the table.

No	Name	95.20 HW options word 1 bit Supply frequency 60 Hz = 50 Hz	95.20 HW options word 1 bit Supply frequency 60 Hz = 60 Hz
11.45	<i>Freq in 1 at scaled max</i>	1500.000	1800.000
15.35	<i>Freq out 1 src max</i>	1500.000	1800.000
12.20	<i>AI1 scaled at AI1 max</i>	50.000	60.000
13.18	<i>AO1 source max</i>	50.0	60.0
22.26	<i>Constant speed 1</i>	300.00 rpm	360.00 rpm
22.27	<i>Constant speed 2</i>	600.00 rpm	720.00 rpm
22.28	<i>Constant speed 3</i>	900.00 rpm	1080.00 rpm
22.29	<i>Constant speed 4</i>	1200.00 rpm	1440.00 rpm
22.30	<i>Constant speed 5</i>	1500.00 rpm	1800.00 rpm
22.30	<i>Constant speed 6</i>	2400.00 rpm	2880.00 rpm
22.31	<i>Constant speed 7</i>	3000.00 rpm	3600.00 rpm
28.26	<i>Constant frequency 1</i>	5.00 Hz	6.00 Hz
28.27	<i>Constant frequency 2</i>	10.00 Hz	12.00 Hz
28.28	<i>Constant frequency 3</i>	15.00 Hz	18.00 Hz
28.29	<i>Constant frequency 4</i>	20.00 Hz	24.00 Hz
28.30	<i>Constant frequency 5</i>	25.00 Hz	30.00 Hz
28.31	<i>Constant frequency 6</i>	40.00 Hz	48.00 Hz
28.32	<i>Constant frequency 7</i>	50.00 Hz	60.00 Hz

438 Parameters

No	Name	95.20 HW options word 1 bit Supply frequency 60 Hz = <b>50 Hz</b>	95.20 HW options word 1 bit Supply frequency 60 Hz = <b>60 Hz</b>
30.11	<i>Minimum speed</i>	0.00 rpm	0.00 rpm
30.12	<i>Maximum speed</i>	1500.00 rpm	1800.00 rpm
30.13	<i>Minimum frequency</i>	0.00 Hz	0.00 Hz
30.14	<i>Maximum frequency</i>	50.00 Hz	60.00 Hz
31.26	<i>Stall speed limit</i>	150.00 rpm	180.00 rpm
31.27	<i>Stall frequency limit</i>	15.00 Hz	18.00 Hz
31.30	<i>Overspeed trip margin</i>	500.00 rpm	500.00 rpm
46.01	<i>Speed scaling</i>	1500.00 rpm	1800.00 rpm
46.02	<i>Frequency scaling</i>	50.00 Hz	60.00 Hz
46.31	<i>Above speed limit</i>	1500.00 rpm	1800.00 rpm
46.32	<i>Above frequency limit</i>	50.00 Hz	60.00 Hz

## Parameters supported by Modbus backwards compatibility with 550

ACx550 compatibility mode is a way to communicate with an ACx580 drive in such a way that it looks like an ACx550 drive over Modbus RTU or Modbus TCP. This mode can be enabled by changing parameter [96.78 550 compatibility mode](#) to Enable.

In the 550 compatibility mode all supported parameters can be read as if the drive were an ACx550. Some parameters are read only and do not support writes. See the table below to see which parameters support writes.

ACx550 parameter	Name	Read/Write	ACx550 parameter	Name	Read/Write
01.01	SPEED & DIR	Read only	01.34	COMM RO WORD	Read only
01.02	SPEED	Read only	01.35	COMM VALUE 1	Read only
01.03	OUTPUT FREQ	Read only	01.36	COMM VALUE 2	Read only
01.04	CURRENT	Read only	01.41	MWH COUNTER	Read only
01.05	TORQUE	Read only	01.43	DRIVE ON TIME	Read only
01.06	POWER	Read only	01.45	MOTOR TEMP	Read only
01.07	DC BUS VOLTAGE	Read only	01.50	CB TEMP	Read only
01.09	OUTPUT VOLTAGE	Read only	01.74	SAVED KWH	Read only
01.10	DRIVE TEMP	Read only	01.75	SAVED MWH	Read only
01.11	EXTERNAL REF 1	Read only	01.77	SAVED AMOUNT 2	Read only
01.13	CTRL LOCATION	Read only	01.78	SAVED CO2	Read only
01.14	RUN TIME	Read only	03.01	FB CMD WORD 1	Read only
01.15	KWH COUNTER	Read only	03.02	FB CMD WORD 2	Read only
01.18	DI 1-3 STATUS	Read only	03.03	FB STS WORD 1	Read only
01.19	DI 4-6 STATUS	Read only	03.04	FB STS WORD 2	Read only
01.20	AI 1	Read only	03.05	FAULT WORD 1	Read only
01.21	AI 2	Read only	03.06	FAULT WORD 2	Read only
01.22	RO 1-3 STATUS	Read only	03.07	FAULT WORD 3	Read only
01.23	RO 4-6 STATUS	Read only	03.08	ALARM WORD 1	Read only
01.24	AO 1	Read only	03.09	ALARM WORD 2	Read only
01.25	AO 2	Read only	04.01	LAST FAULT	Read only
01.26	PID 1 OUTPUT	Read only	04.12	PREVIOUS FAULT 1	Read only
01.27	PID 2 OUTPUT	Read only	04.13	PREVIOUS FAULT 2	Read only
01.28	PID 1 SETPNT	Read only	10.01	EXT1 COMMANDS	Read/Write
01.29	PID 2 SETPNT	Read only	10.02	EXT2 COMMANDS	Read/Write
01.30	PID 1 FBK	Read only	10.03	DIRECTION	Read/Write
01.31	PID 2 FBK	Read only	10.04	JOGGING SEL	Read/Write
01.32	PID 1 DEVIATION	Read only	11.02	EXT1/EXT2 SEL	Read/Write
01.33	PID 2 DEVIATION	Read only	11.03	REF1 SELECT	Read/Write

## 440 Parameters

ACx550 parameter	Name	Read/Write
11.04	REF1 MIN	Read/Write
11.05	REF1 MAX	Read/Write
11.06	REF2 SEL	Read/Write
11.07	REF2 MIN	Read/Write
11.08	REF2 MAX	Read/Write
12.01	CONST SPEED SEL	Read/Write
12.02	CONST SPEED 1	Read/Write
12.03	CONST SPEED 2	Read/Write
12.04	CONST SPEED 3	Read/Write
12.05	CONST SPEED 4	Read/Write
12.06	CONST SPEED 5	Read/Write
12.07	CONST SPEED 6	Read/Write
15.02	CONST SPEED 7	Read/Write
15.03	AO1 CONTENT MAX	Read/Write
15.04	MINIMUM AO1	Read/Write
15.05	MAXIMUM AO1	Read/Write
15.08	AO2 CONTENT MIN	Read/Write
15.09	AO2 CONTENT MAX	Read/Write
15.10	MINIMUM AO2	Read/Write
15.11	MAXIMUM AO2	Read/Write
16.01	RUN ENABLE	Read/Write
16.02	PARAMETER LOCK	Read/Write
16.03	PASS CODE	Read/Write
16.08	START ENABLE 1	Read/Write
16.09	START ENABLE 2	Read/Write
20.01	MINIMUM SPEED	Read/Write
20.02	MAXIMUM SPEED	Read/Write
20.03	MAX CURRENT	Read/Write
20.06	UNDERVOLT CRTL	Read/Write
20.07	MINIMUM FREQ	Read/Write
20.08	MAXIMUM FREQ	Read/Write
20.13	MIN TORQUE SEL	Read/Write
20.14	MAX TORQUE SEL	Read/Write
20.15	MIN TORQUE 1	Read/Write
20.16	MIN TORQUE 2	Read/Write
20.17	MAX TORQUE 1	Read/Write
20.18	MAX TORQUE 2	Read/Write
21.02	STOP FUNCTION	Read/Write
21.03	DC MAGN TIME	Read/Write

ACx550 parameter	Name	Read/Write
21.05	DC HOLD SPEED	Read/Write
21.06	DC CURR REF	Read/Write
21.09	EMERG STOP SEL	Read/Write
21.12	ZERO SPEED DELAY	Read/Write
21.13	START DELAY	Read/Write
22.02	ACCELER TIME 1	Read/Write
22.03	DECELER TIME 1	Read/Write
22.04	RAMP SHAPE 1	Read/Write
22.05	ACCELER TIME 2	Read/Write
22.06	DECELER TIME 2	Read/Write
22.07	RAMP SHAPE 2	Read/Write
22.08	EMERG DEC TIME	Read/Write
23.01	PROP GAIN	Read/Write
23.02	INTEGRATION TIME	Read/Write
23.03	DERIVATION TIME	Read/Write
23.04	ACC COMPENSATION	Read/Write
30.02	PANEL COMM ERR	Read/Write
30.03	EXTERNAL REF 1	Read/Write
30.04	EXTERNAL REF 2	Read/Write
30.05	MOT THERM POT	Read/Write
30.06	MOT THERM TIME	Read/Write
30.07	MOT LOAD CURVE	Read/Write
30.08	ZERO SPEED LOAD	Read/Write
30.09	BREAK POINT FREQ	Read/Write
30.10	STALL FUNCTION	Read/Write
30.11	STALL FREQUENCY	Read/Write
30.12	STALL TIME	Read/Write
30.17	EARTH FAULT	Read/Write
30.18	COMM FAULT FUNC	Read/Write
30.19	COMM FAULT TIME	Read/Write
30.22	AI2 FAULT LIMIT	Read/Write
30.23	WIRING FAULT	Read/Write
33.01	FIRMWARE	Read only
33.02	LOADING PACKAGE	Read only
33.03	TEST DATE	Read only
33.04	DRIVE RATING	Read only
40.01	GAIN	Read/Write
40.02	INTEGRATION TIME	Read/Write
40.03	DERIVATION TIME	Read/Write



ACx550 parameter	Name	Read/Write
40.04	PID DERIV FILTER	Read/Write
40.08	0% VALUE	Read/Write
40.09	100% VALUE	Read/Write
40.10	SET POINT SEL	Read/Write
40.11	INTERNAL SETPNT	Read/Write
40.12	SETPOINT MIN	Read/Write
40.13	SETPOINT MAX	Read/Write
40.14	FBK SEL	Read/Write
40.15	FBK MULTIPLIER	Read/Write
40.16	ACT 1 INPUT	Read/Write
40.17	ACT 2 INPUT	Read/Write
40.24	PID SLEEP DELAY	Read/Write
40.25	WAKE-UP DEV	Read/Write
40.26	WAKE-UP DELAY	Read/Write
40.27	PID 1 PARAM SET	Read/Write
41.01	GAIN	Read/Write
41.02	INTEGRATION TIME	Read/Write
41.03	DERIVATION TIME	Read/Write
41.04	PID DERIV FILTER	Read/Write
41.08	0% VALUE	Read/Write
41.09	100% VALUE	Read/Write
41.10	SET POINT SEL	Read/Write

ACx550 parameter	Name	Read/Write
41.11	INTERNAL SETPNT	Read/Write
41.12	SETPOINT MIN	Read/Write
41.13	SETPOINT MAX	Read/Write
41.14	FBK SEL	Read/Write
41.15	FBK MULTIPLIER	Read/Write
41.16	ACT 1 INPUT	Read/Write
41.17	ACT 2 INPUT	Read/Write
41.24	PID SLEEP DELAY	Read/Write
41.25	WAKE-UP DEV	Read/Write
41.26	WAKE-UP DELAY	Read/Write
42.11	INTERNAL SETPNT	Read/Write
53.05	EFB CTRL PROFILE	Read/Write
99.01	LANGUAGE	Read/Write
99.04	MOTOR CTRL MODE	Read/Write
99.05	MOTOR NOM VOLT	Read/Write
99.06	MOTOR NOM CURR	Read/Write
99.07	MOTOR NOM FREQ	Read/Write
99.08	MOTOR NOM SPEED	Read/Write
99.09	MOTOR NOM POWER	Read/Write
99.10	ID RUN	Read/Write
99.15	MOTOR COS PHI	Read/Write



## 8

# Additional parameter data

---

## What this chapter contains

This chapter lists the parameters with some additional data such as their ranges and 32-bit fieldbus scaling. For parameter descriptions, see chapter [Parameters](#) (page [195](#)).

## Terms and abbreviations

Term	Definition
Actual signal	Signal measured or calculated by the drive. Usually can only be monitored but not adjusted; some counter-type signals can however be reset.
Analog src	Analog source: the parameter can be set to the value of another parameter by choosing "Other", and selecting the source parameter from a list. In addition to the "Other" selection, the parameter may offer other pre-selected settings.
Binary src	Binary source: the value of the parameter can be taken from a specific bit in another parameter value ("Other"). Sometimes the value can be fixed to 0 (false) or 1 (true). In addition, the parameter may offer other pre-selected settings.
Data	Data parameter
FbEq32	32-bit fieldbus equivalent: The scaling between the value shown on the panel and the integer used in communication when a 32-bit value is selected for transmission to an external system. The corresponding 16-bit scalings are listed in chapter <a href="#">Parameters</a> (page <a href="#">195</a> ).
List	Selection list.

---

<b>Term</b>	<b>Definition</b>
No.	Parameter number.
PB	Packed Boolean (bit list).
Real	Real number.
Type	Parameter type. See <a href="#">Analog src</a> , <a href="#">Binary src</a> , <a href="#">List</a> , <a href="#">PB</a> , <a href="#">Real</a> .

## **Fieldbus addresses**

Refer to the *User's manual* of the fieldbus adapter.

---

## Parameter groups 1...9

No.	Name	Type	Range	Unit	FbEq32
<b>01 Actual values</b>					
01.01	Motor speed used	<i>Real</i>	-30000.00...30000.00	rpm	100 = 1 rpm
01.02	Motor speed estimated	<i>Real</i>	-30000.00...30000.00	rpm	100 = 1 rpm
01.03	Motor speed %	<i>Real</i>	-1000.00...1000.00	%	100 = 1%
01.06	Output frequency	<i>Real</i>	-500.00...500.00	Hz	100 = 1 Hz
01.07	Motor current	<i>Real</i>	0.00...30000.00	A	100 = 1 A
01.08	Motor current % of motor nom	<i>Real</i>	0.0...1000.0	%	10 = 1%
01.09	Motor current % of drive nom	<i>Real</i>	0.0...1000.0	%	10 = 1%
01.10	Motor torque	<i>Real</i>	-1600.0...1600.0	%	10 = 1%
01.11	DC voltage	<i>Real</i>	0.00...2000.00	V	100 = 1 V
01.13	Output voltage	<i>Real</i>	0...2000	V	1 = 1 V
01.14	Output power	<i>Real</i>	-32768.00...32767.00	kW	100 = 1 unit
01.15	Output power % of motor nom	<i>Real</i>	-300.00...300.00	%	100 = 1%
01.17	Motor shaft power	<i>Real</i>	-32768.00...32767.00	kW or hp	100 = 1 unit
01.18	Inverter GWh counter	<i>Real</i>	0...65535	GWh	1 = 1 GWh
01.19	Inverter MWh counter	<i>Real</i>	0...1000	MWh	1 = 1 MWh
01.20	Inverter kWh counter	<i>Real</i>	0...1000	kWh	1 = 1 kWh
01.24	Flux actual %	<i>Real</i>	0...200	%	1 = 1%
01.30	Nominal torque scale	<i>Real</i>	0.000...4000000.000	N·m or lb-ft	1000 = 1 unit
01.50	Current hour kWh	<i>Real</i>	0.00...1000000.00	kWh	100 = 1 kWh
01.51	Previous hour kWh	<i>Real</i>	0.00...1000000.00	kWh	100 = 1 kWh
01.52	Current day kWh	<i>Real</i>	0.00...1000000.00	kWh	100 = 1 kWh
01.53	Previous day kWh	<i>Real</i>	0.00...1000000.00	kWh	100 = 1 kWh
01.54	Cumulative inverter energy	<i>Real</i>	-20000000.0... 20000000.0	kWh	1 = 1 kWh
01.55	Inverter GWh counter (resettable)	<i>Real</i>	0...65535	GWh	1 = 1 GWh
01.56	Inverter MWh counter (resettable)	<i>Real</i>	0...1000	MWh	1 = 1 MWh
01.57	Inverter kWh counter (resettable)	<i>Real</i>	0...1000	kWh	1 = 1 kWh
01.58	Cumulative inverter energy (resettable)	<i>Real</i>	-20000000.0... 20000000.0	kWh	1 = 1 kWh
01.61	Abs motor speed used		0.00...30000.00	rpm	100 = 1 rpm
01.62	Abs motor speed %		0.00...1000.00%	%	100 = 1%
01.63	Abs output frequency		0.00...500.00 Hz	Hz	100 = 1 Hz
01.64	Abs motor torque		0.0...1600.0	%	10 = 1%
01.65	Abs output power		0.00...32767.00	kW	100 = 1 kW
01.66	Abs output power % motor nom		0.00...300.00	%	100 = 1%
01.67	Abs output power % drive nom		0.00...300.00	%	100 = 1%
01.68	Abs motor shaft power		0.00...32767.00	kW	100 = 1 kW

446 Additional parameter data

No.	Name	Type	Range	Unit	FbEq32
<b>03 Input references</b>					
03.01	Panel reference	<i>Real</i>	-100000.00...100000.00	-	100 = 1
03.02	Panel reference remote	<i>Real</i>	-100000.00...100000.00	-	100 = 1
03.05	FB A reference 1	<i>Real</i>	-100000.00...100000.00	-	100 = 1
03.06	FB A reference 2	<i>Real</i>	-100000.00...100000.00	-	100 = 1
03.09	EFB reference 1	<i>Real</i>	-30000.00...30000.00	-	100 = 1
03.10	EFB reference 2	<i>Real</i>	-30000.00...30000.00	-	100 = 1
<b>04 Warnings and faults</b>					
04.01	Tripping fault	<i>Data</i>	0000h...FFFFh	-	1 = 1
04.02	Active fault 2	<i>Data</i>	0000h...FFFFh	-	1 = 1
04.03	Active fault 3	<i>Data</i>	0000h...FFFFh	-	1 = 1
04.06	Active warning 1	<i>Data</i>	0000h...FFFFh	-	1 = 1
04.07	Active warning 2	<i>Data</i>	0000h...FFFFh	-	1 = 1
04.08	Active warning 3	<i>Data</i>	0000h...FFFFh	-	1 = 1
04.11	Latest fault	<i>Data</i>	0000h...FFFFh	-	1 = 1
04.12	2nd latest fault	<i>Data</i>	0000h...FFFFh	-	1 = 1
04.13	3rd latest fault	<i>Data</i>	0000h...FFFFh	-	1 = 1
04.16	Latest warning	<i>Data</i>	0000h...FFFFh	-	1 = 1
04.17	2nd latest warning	<i>Data</i>	0000h...FFFFh	-	1 = 1
04.18	3rd latest warning	<i>Data</i>	0000h...FFFFh	-	1 = 1
04.40	Event word 1	<i>PB</i>	0000h...FFFFh	-	1 = 1
04.41	Event word 1 bit 0 code	<i>Data</i>	0x2310...FFFFh	-	1 = 1
04.43	Event word 1 bit 1 code	<i>Data</i>	0x3210...FFFFh	-	1 = 1
04.45, 04.47, 04.49, ...	...	...	...	...	
04.71	Event word 1 bit 15 code	<i>Data</i>	0x2330...FFFFh	-	1 = 1
<b>05 Diagnostics</b>					
05.01	On-time counter	<i>Real</i>	0...65535	d	1 = 1 d
05.02	Run-time counter	<i>Real</i>	0...65535	d	1 = 1 d
05.03	Hours run	<i>Real</i>	0.0...429496729.5	h	10 = 1 h
05.04	Fan on-time counter	<i>Real</i>	0...65535	d	1 = 1 d
05.08	Cabinet temperature	<i>Real</i>	-40...120	°C or °F	10 = 1 °
05.10	Control board temperature	<i>Real</i>	-100...300	°C or °F	10 = 1 °
05.11	Inverter temperature	<i>Real</i>	-40.0...160.0	%	10 = 1 %
05.20	Diagnostic word 1	<i>PB</i>	0000h...FFFFh	-	
05.21	Diagnostic word 2	<i>PB</i>	0000h...FFFFh	-	
05.22	Diagnostic word 3	<i>PB</i>	0000h...FFFFh	-	
05.80	Motor speed at fault	<i>Real</i>	-30000.00...30000.00	rpm	100 = 1 rpm
05.81	Output frequency at fault	<i>Real</i>	-500.00...500.00	Hz	100 = 1 Hz
05.82	DC voltage at fault	<i>Real</i>	0.00...2000.00	V	100 = 1 V

No.	Name	Type	Range	Unit	FbEq32
05.83	Motor current at fault	<i>Real</i>	0.00...30000.00	A	100 = 1 A
05.84	Motor torque at fault	<i>Real</i>	-1600.0...1600.0	%	10 = 1%
05.85	Main status word at fault	<i>PB</i>	0000h...FFFFh	-	1 = 1
05.86	DI delayed status at fault	<i>PB</i>	0000h...FFFFh	-	1 = 1
05.87	Inverter temperature at fault	<i>Real</i>	-40...160	°C	10 = 1%
05.88	Reference used at fault	<i>Real</i>	-30000.00...30000.00	Hz	100 = 1 Hz
<b>06 Control and status words</b>					
06.01	Main control word	<i>PB</i>	0000h...FFFFh	-	1 = 1
06.11	Main status word	<i>PB</i>	0000h...FFFFh	-	1 = 1
06.16	Drive status word 1	<i>PB</i>	0000h...FFFFh	-	1 = 1
06.17	Drive status word 2	<i>PB</i>	0000h...FFFFh	-	1 = 1
06.18	Start inhibit status word	<i>PB</i>	0000h...FFFFh	-	1 = 1
06.19	Speed control status word	<i>PB</i>	0000h...FFFFh	-	1 = 1
06.20	Constant speed status word	<i>PB</i>	0000h...FFFFh	-	1 = 1
06.21	Drive status word 3	<i>PB</i>	0000h...FFFFh	-	1 = 1
06.29	MSW bit 10 selection	<i>Binary src</i>	-	-	1 = 1
06.30	MSW bit 11 selection	<i>Binary src</i>	-	-	1 = 1
06.31	MSW bit 12 selection	<i>Binary src</i>	-	-	1 = 1
06.32	MSW bit 13 selection	<i>Binary src</i>	-	-	1 = 1
06.33	MSW bit 14 selection	<i>Binary src</i>	-	-	1 = 1
<b>07 System info</b>					
07.03	Drive rating id	<i>List</i>	-	-	1 = 1
07.04	Firmware name	<i>List</i>	-	-	1 = 1
07.05	Firmware version	<i>Data</i>	-	-	1 = 1
07.06	Loading package name	<i>List</i>	-	-	1 = 1
07.07	Loading package version	<i>Data</i>	-	-	1 = 1
07.10	Language file set	<i>List</i>	0...3	-	1 = 1
07.11	Cpu usage	<i>Real</i>	0...100	%	1 = 1%
07.25	Customization package name	<i>Data</i>	-	-	1 = 1
07.26	Customization package version	<i>Data</i>	-	-	1 = 1
07.30	Adaptive program status	<i>PB</i>	0000h...FFFFh	-	1 = 1
07.31	AP sequence state	<i>Data</i>	0...20	-	1 = 1
07.35	Drive configuration	<i>PB</i>	0000h...FFFFh	-	1 = 1
07.36	Drive configuration 2	<i>PB</i>	0000h...FFFFh	-	1 = 1

## Parameter groups 10...99

No.	Name	Type	Range	Unit	FbEq32
<b>10 Standard DI, RO</b>					
10.01	DI status	<i>PB</i>	0000h...FFFFh	-	1 = 1
10.02	DI delayed status	<i>PB</i>	0000h...FFFFh	-	1 = 1
10.03	DI force selection	<i>PB</i>	0000h...FFFFh	-	1 = 1
10.04	DI forced data	<i>PB</i>	0000h...FFFFh	-	1 = 1
10.05	DI1 ON delay	<i>Real</i>	0.00...3000.00	s	100 = 1
10.06	DI1 OFF delay	<i>Real</i>	0.00...3000.00	s	100 = 1
10.07	DI2 ON delay	<i>Real</i>	0.00...3000.00	s	100 = 1
10.08	DI2 OFF delay	<i>Real</i>	0.00...3000.00	s	100 = 1
10.09	DI3 ON delay	<i>Real</i>	0.00...3000.00	s	100 = 1
10.10	DI3 OFF delay	<i>Real</i>	0.00...3000.00	s	100 = 1
10.11	DI4 ON delay	<i>Real</i>	0.00...3000.00	s	100 = 1
10.12	DI4 OFF delay	<i>Real</i>	0.00...3000.00	s	100 = 1
10.13	DI5 ON delay	<i>Real</i>	0.00...3000.00	s	100 = 1
10.14	DI5 OFF delay	<i>Real</i>	0.00...3000.00	s	100 = 1
10.15	DI6 ON delay	<i>Real</i>	0.00...3000.00	s	100 = 1
10.16	DI6 OFF delay	<i>Real</i>	0.00...3000.00	s	100 = 1
10.21	RO status	<i>PB</i>	0000h...FFFFh	-	1 = 1
10.22	RO force selection	<i>PB</i>	0000h...FFFFh	-	1 = 1
10.23	RO forced data	<i>PB</i>	0000h...FFFFh	-	1 = 1
10.24	RO1 source	<i>Binary src</i>	-	-	1 = 1
10.25	RO1 ON delay	<i>Real</i>	0.0...3000.0	s	10 = 1 s
10.26	RO1 OFF delay	<i>Real</i>	0.0...3000.0	s	10 = 1 s
10.27	RO2 source	<i>Binary src</i>	-	-	1 = 1
10.28	RO2 ON delay	<i>Real</i>	0.0...3000.0	s	10 = 1 s
10.29	RO2 OFF delay	<i>Real</i>	0.0...3000.0	s	10 = 1 s
10.30	RO3 source	<i>Binary src</i>	-	-	1 = 1
10.31	RO3 ON delay	<i>Real</i>	0.0...3000.0	s	10 = 1 s
10.32	RO3 OFF delay	<i>Real</i>	0.0...3000.0	s	10 = 1 s
10.99	RO/DIO control word	<i>PB</i>	0000h...FFFFh	-	1 = 1
10.101	RO1 toggle counter	<i>Real</i>	0...4294967000	-	1 = 1
10.102	RO2 toggle counter	<i>Real</i>	0...4294967000	-	1 = 1
10.103	RO3 toggle counter	<i>Real</i>	0...4294967000	-	1 = 1
<b>11 Standard DIO, FI, FO</b>					
11.21	DI5 configuration	<i>List</i>	0...1	-	1 = 1
11.38	Freq in 1 actual value	<i>Real</i>	0...16000	Hz	1 = 1 Hz
11.39	Freq in 1 scaled value	<i>Real</i>	-32768.000...32767.000	-	1000 = 1



No.	Name	Type	Range	Unit	FbEq32
11.42	Freq in 1 min	<i>Real</i>	0...16000	Hz	1 = 1 Hz
11.43	Freq in 1 max	<i>Real</i>	0...16000	Hz	1 = 1 Hz
11.44	Freq in 1 at scaled min	<i>Real</i>	-32768.000...32767.000	-	1000 = 1
11.45	Freq in 1 at scaled max	<i>Real</i>	-32768.000...32767.000	-	1000 = 1
<b>12 Standard AI</b>					
12.02	AI force selection	<i>PB</i>	0000h...FFFFh	-	1 = 1
12.03	AI supervision function	<i>List</i>	0...4	-	1 = 1
12.04	AI supervision selection	<i>PB</i>	0000h...FFFFh	-	1 = 1
12.11	AI1 actual value	<i>Real</i>	0.000...20.000 mA or 0.000...10.000 V	mA or V	1000 = 1 unit
12.12	AI1 scaled value	<i>Real</i>	-32768.000...32767.000	-	1000 = 1
12.13	AI1 forced value	<i>Real</i>	0.000...20.000 mA or 0.000...10.000 V	mA or V	1000 = 1 unit
12.15	AI1 unit selection	<i>List</i>	2, 10	-	1 = 1
12.16	AI1 filter time	<i>Real</i>	0.000...30.000	s	1000 = 1 s
12.17	AI1 min	<i>Real</i>	0.000...20.000 mA or 0.000...10.000 V	mA or V	1000 = 1 unit
12.18	AI1 max	<i>Real</i>	0.000...20.000 mA or 0.000...10.000 V	mA or V	1000 = 1 unit
12.19	AI1 scaled at AI1 min	<i>Real</i>	-32768.000...32767.000	-	1000 = 1
12.20	AI1 scaled at AI1 max	<i>Real</i>	-32768.000...32767.000	-	1000 = 1
12.21	AI2 actual value	<i>Real</i>	0.000...20.000 mA or 0.000...10.000 V	mA or V	1000 = 1 unit
12.22	AI2 scaled value	<i>Real</i>	-32768.000...32767.000	-	1000 = 1
12.23	AI2 forced value	<i>Real</i>	0.000...20.000 mA or 0.000...10.000 V	mA or V	1000 = 1 unit
12.25	AI2 unit selection	<i>List</i>	2, 10	-	1 = 1
12.26	AI2 filter time	<i>Real</i>	0.000...30.000	s	1000 = 1 s
12.27	AI2 min	<i>Real</i>	0.000...20.000 mA or 0.000...10.000 V	mA or V	1000 = 1 unit
12.28	AI2 max	<i>Real</i>	0.000...20.000 mA or 0.000...10.000 V	mA or V	1000 = 1 unit
12.29	AI2 scaled at AI2 min	<i>Real</i>	-32768.000...32767.000	-	1000 = 1
12.30	AI2 scaled at AI2 max	<i>Real</i>	-32768.000...32767.000	-	1000 = 1
12.101	AI1 percent value	<i>Real</i>	0.00...100.00	%	100 = 1%
12.102	AI2 percent value	<i>Real</i>	0.00...100.00	%	100 = 1%
<b>13 Standard AO</b>					
13.02	AO force selection	<i>PB</i>	0000h...FFFFh	-	1 = 1
13.11	AO1 actual value	<i>Real</i>	0.000...22.000 or 0.000...11000 V	mA	1000 = 1 mA
13.12	AO1 source	<i>Analog src</i>	-	-	1 = 1
13.13	AO1 forced value	<i>Real</i>	0.000...22.000 or 0.000...11000 V	mA	1000 = 1 mA
13.15	AO1 unit selection	<i>List</i>	2, 10	-	1 = 1

450 Additional parameter data

No.	Name	Type	Range	Unit	FbEq32
13.16	AO1 filter time	<i>Real</i>	0.000...30.000	s	1000 = 1 s
13.17	AO1 source min	<i>Real</i>	-32768.0...32767.0	-	10 = 1
13.18	AO1 source max	<i>Real</i>	-32768.0...32767.0	-	10 = 1
13.19	AO1 out at AO1 src min	<i>Real</i>	0.000...22.000 or 0.000...11000 V	mA	1000 = 1 mA
13.20	AO1 out at AO1 src max	<i>Real</i>	0.000...22.000 or 0.000...11000 V	mA	1000 = 1 mA
13.21	AO2 actual value	<i>Real</i>	0.000...22.000	mA	1000 = 1 mA
13.22	AO2 source	<i>Analog src</i>	-	-	1 = 1
13.23	AO2 forced value	<i>Real</i>	0.000...22.000	mA	1000 = 1 mA
13.26	AO2 filter time	<i>Real</i>	0.000...30.000	s	1000 = 1 s
13.27	AO2 source min	<i>Real</i>	-32768.0...32767.0	-	10 = 1
13.28	AO2 source max	<i>Real</i>	-32768.0...32767.0	-	10 = 1
13.29	AO2 out at AO2 src min	<i>Real</i>	0.000...22.000	mA	1000 = 1 mA
13.30	AO2 out at AO2 src max	<i>Real</i>	0.000...22.000	mA	1000 = 1 mA
13.91	AO1 data storage	<i>Real</i>	-327.68...327.67	-	100 = 1
13.92	AO2 data storage	<i>Real</i>	-327.68...327.67	-	100 = 1
<b>15 I/O extension module</b>					
15.01	Extension module type	<i>List</i>	0...4	-	1 = 1
15.02	Detected extension module	<i>List</i>	0...4	-	1 = 1
15.03	DI status	<i>PB</i>	0000h...FFFFh	-	1 = 1
15.04	RO/DO status	<i>PB</i>	0000h...FFFFh	-	1 = 1
15.05	RO/DO force selection	<i>PB</i>	0000h...FFFFh	-	1 = 1
15.06	RO/DO forced data	<i>PB</i>	0000h...FFFFh	-	1 = 1
15.07	RO4 source	<i>Binary src</i>	-	-	1 = 1
15.08	RO4 ON delay	<i>Real</i>	0.0...3000.0	s	10 = 1 s
15.09	RO4 OFF delay	<i>Real</i>	0.0...3000.0	s	10 = 1 s
15.10	RO5 source	<i>Binary src</i>	-	-	1 = 1
15.11	RO5 ON delay	<i>Real</i>	0.0...3000.0	s	10 = 1 s
15.12	RO5 OFF delay	<i>Real</i>	0.0...3000.0	s	10 = 1 s
15.22	DO1 configuration	<i>List</i>	0, 2	-	1 = 1
15.23	DO1 source	<i>Binary src</i>	-	-	1 = 1
15.24	DO1 ON delay	<i>Real</i>	0.0...3000.0	s	10 = 1 s
15.25	DO1 OFF delay	<i>Real</i>	0.0...3000.0	s	10 = 1 s
15.32	Freq out 1 actual value	<i>Real</i>	0...16000	Hz	1 = 1 Hz
15.33	Freq out 1 source	<i>Analog src</i>	-	-	1 = 1
15.34	Freq out 1 src min	<i>Real</i>	-32768.0...32767.0	-	1000 = 1
15.35	Freq out 1 src max	<i>Real</i>	-32768.0...32767.0	-	1000 = 1

No.	Name	Type	Range	Unit	FbEq32
15.36	Freq out 1 at src min	<i>Real</i>	0...16000	Hz	1 = 1 Hz
15.37	Freq out 1 at src max	<i>Real</i>	0...16000	Hz	1 = 1 Hz
<b>19 Operation mode</b>					
19.01	Actual operation mode	<i>List</i>	1...6, 10, 20	-	1 = 1
19.11	Ext1/Ext2 selection	<i>Binary src</i>	-	-	1 = 1
19.12	Ext1 control mode	<i>List</i>	1...5	-	1 = 1
19.14	Ext2 control mode	<i>List</i>	1...5	-	1 = 1
19.16	Local control mode	<i>List</i>	0...1	-	1 = 1
19.17	Local control disable	<i>List</i>	0...1	-	1 = 1
<b>20 Start/stop/direction</b>					
20.01	Ext1 commands	<i>List</i>	0...6, 11...12, 14	-	1 = 1
20.02	Ext1 start trigger type	<i>List</i>	0...1	-	1 = 1
20.03	Ext1 in1 source	<i>Binary src</i>	-	-	1 = 1
20.04	Ext1 in2 source	<i>Binary src</i>	-	-	1 = 1
20.05	Ext1 in3 source	<i>Binary src</i>	-	-	1 = 1
20.06	Ext2 commands	<i>List</i>	0...6, 11...12, 14	-	1 = 1
20.07	Ext2 start trigger type	<i>List</i>	0...1	-	1 = 1
20.08	Ext2 in1 source	<i>Binary src</i>	-	-	1 = 1
20.09	Ext2 in2 source	<i>Binary src</i>	-	-	1 = 1
20.10	Ext2 in3 source	<i>Binary src</i>	-	-	1 = 1
20.11	Run enable stop mode	<i>List</i>	0...2	-	1 = 1
20.12	Run enable 1 source	<i>Binary src</i>	-	-	1 = 1
20.19	Enable start command	<i>Binary src</i>	-	-	1 = 1
20.21	Direction	<i>List</i>	0...2	-	1 = 1
20.22	Enable to rotate	<i>Binary src</i>	-	-	1 = 1
20.25	Jogging enable	<i>Binary src</i>	-	-	1 = 1
20.26	Jogging 1 start source	<i>Binary src</i>	-	-	1 = 1
20.27	Jogging 2 start source	<i>Binary src</i>	-	-	1 = 1
20.30	Enable signal warning function	<i>PB</i>	0000h...FFFFh	-	1 = 1
<b>21 Start/stop mode</b>					
21.01	Start mode	<i>List</i>	0...2	-	1 = 1
21.02	Magnetization time	<i>Real</i>	0...10000	ms	1 = 1 ms

452 Additional parameter data

No.	Name	Type	Range	Unit	FbEq32
21.03	Stop mode	List	0...2	-	1 = 1
21.04	Emergency stop mode	List	0...2	-	1 = 1
21.05	Emergency stop source	Binary src	-	-	1 = 1
21.06	Zero speed limit	Real	0.00...30000.00	rpm	100 = 1 rpm
21.07	Zero speed delay	Real	0...30000	ms	1 = 1 ms
21.08	DC current control	PB	0000b...0011b	-	1 = 1
21.09	DC hold speed	Real	0.00...1000.00	rpm	100 = 1 rpm
21.10	DC current reference	Real	0.0...100.0	%	10 = 1%
21.11	Post magnetization time	Real	0...3000	s	1 = 1 s
21.14	Pre-heating input source	Binary src	-	-	1 = 1
21.15	Pre-heating time delay	Real	10...3000	s	1 = 1 s
21.16	Pre-heating current	Real	0.0...30.0	%	10 = 1%
21.18	Auto restart time	Real	0.0, 0.1...10.0	s	10 = 1 s
21.19	Scalar start mode	List	0...6	-	1 = 1
21.21	DC hold frequency	Real	0.00...1000.00	Hz	100 = 1 Hz
21.22	Start delay	Real	0.00...60.00	s	100 = 1 s
21.23	Smooth start	Real	0...2	-	1 = 1
21.24	Smooth start current	Real	10.0...200.0	%	100 = 1%
21.25	Smooth start speed	Real	2.0...100.0	%	100 = 1%
21.26	Torque boost current	Real	15.0...300.0	%	100 = 1%
21.27	Torque boost time	Real	0.0...60.0	s	10 = 1 s
21.30	Speed compensated stop mode	Real	0...3	-	1 = 1
21.31	Speed comp stop delay	Real	0.00...1000.00	s	100 = 1 s
21.32	Speed comp stop threshold	Real	0...100	%	1 = 1%
21.34	Force auto restart	List	0...1	-	1 = 1
21.35	Preheating power	Real	0.00....10.00	kW	100 = 1 kW
21.36	Preheating unit	List	0...1	-	1 = 1
<b>22 Speed reference selection</b>					
22.01	Speed ref unlimited	Real	-30000.00...30000.00	rpm	100 = 1 rpm
22.11	Ext1 speed ref1	Analog src	-	-	1 = 1
22.12	Ext1 speed ref2	Analog src	-	-	1 = 1
22.13	Ext1 speed function	List	0...5	-	1 = 1
22.18	Ext2 speed ref1	Analog src	-	-	1 = 1
22.19	Ext2 speed ref2	Analog src	-	-	1 = 1
22.20	Ext2 speed function	List	0...5	-	1 = 1
22.21	Constant speed function	PB	0000h...FFFFh	-	1 = 1

No.	Name	Type	Range	Unit	FbEq32
22.22	Constant speed sel1	<i>Binary src</i>	-	-	1 = 1
22.23	Constant speed sel2	<i>Binary src</i>	-	-	1 = 1
22.24	Constant speed sel3	<i>Binary src</i>	-	-	1 = 1
22.26	Constant speed 1	<i>Real</i>	-30000.00...30000.00	rpm	100 = 1 rpm
22.27	Constant speed 2	<i>Real</i>	-30000.00...30000.00	rpm	100 = 1 rpm
22.28	Constant speed 3	<i>Real</i>	-30000.00...30000.00	rpm	100 = 1 rpm
22.29	Constant speed 4	<i>Real</i>	-30000.00...30000.00	rpm	100 = 1 rpm
22.30	Constant speed 5	<i>Real</i>	-30000.00...30000.00	rpm	100 = 1 rpm
22.31	Constant speed 6	<i>Real</i>	-30000.00...30000.00	rpm	100 = 1 rpm
22.32	Constant speed 7	<i>Real</i>	-30000.00...30000.00	rpm	100 = 1 rpm
22.41	Speed ref safe	<i>Real</i>	-30000.00...30000.00	rpm	100 = 1 rpm
22.42	Jogging 1 ref	<i>Real</i>	-30000.00...30000.00	rpm	100 = 1 rpm
22.43	Jogging 2 ref	<i>Real</i>	-30000.00...30000.00	rpm	100 = 1 rpm
22.51	Critical speed function	<i>PB</i>	00b...11b	-	1 = 1
22.52	Critical speed 1 low	<i>Real</i>	-30000.00...30000.00	rpm	100 = 1 rpm
22.53	Critical speed 1 high	<i>Real</i>	-30000.00...30000.00	rpm	100 = 1 rpm
22.54	Critical speed 2 low	<i>Real</i>	-30000.00...30000.00	rpm	100 = 1 rpm
22.55	Critical speed 2 high	<i>Real</i>	-30000.00...30000.00	rpm	100 = 1 rpm
22.56	Critical speed 3 low	<i>Real</i>	-30000.00...30000.00	rpm	100 = 1 rpm
22.57	Critical speed 3 high	<i>Real</i>	-30000.00...30000.00	rpm	100 = 1 rpm
22.71	Motor potentiometer function	<i>List</i>	0...3	-	1 = 1
22.72	Motor potentiometer initial value	<i>Real</i>	-32768.00...32767.00	-	100 = 1
22.73	Motor potentiometer up source	<i>Binary src</i>	-	-	1 = 1
22.74	Motor potentiometer down source	<i>Binary src</i>	-	-	1 = 1
22.75	Motor potentiometer ramp time	<i>Real</i>	0.0...3600.0	s	10 = 1 s
22.76	Motor potentiometer min value	<i>Real</i>	-32768.00...32767.00	-	100 = 1
22.77	Motor potentiometer max value	<i>Real</i>	-32768.00...32767.00	-	100 = 1
22.80	Motor potentiometer ref act	<i>Real</i>	-32768.00...32767.00	-	100 = 1
22.86	Speed reference act 6	<i>Real</i>	-30000.00...30000.00	rpm	100 = 1 rpm
22.87	Speed reference act 7	<i>Real</i>	-30000.00...30000.00	rpm	100 = 1 rpm
<b>23 Speed reference ramp</b>					
23.01	Speed ref ramp input	<i>Real</i>	-30000.00...30000.00	rpm	100 = 1 rpm
23.02	Speed ref ramp output	<i>Real</i>	-30000.00...30000.00	rpm	100 = 1 rpm
23.11	Ramp set selection	<i>Binary src</i>	-	-	1 = 1
23.12	Acceleration time 1	<i>Real</i>	0.000...1800.000	s	1000 = 1 s
23.13	Deceleration time 1	<i>Real</i>	0.000...1800.000	s	1000 = 1 s

454 Additional parameter data

No.	Name	Type	Range	Unit	FbEq32
23.14	Acceleration time 2	<i>Real</i>	0.000...1800.000	s	1000 = 1 s
23.15	Deceleration time 2	<i>Real</i>	0.000...1800.000	s	1000 = 1 s
23.20	Acc time jogging	<i>Real</i>	0.000...1800.000	s	1000 = 1 s
23.21	Dec time jogging	<i>Real</i>	0.000...1800.000	s	1000 = 1 s
23.23	Emergency stop time	<i>Real</i>	0.000...1800.000	s	1000 = 1 s
23.28	Variable slope enable	<i>List</i>	0...1	-	1 = 1
23.29	Variable slope rate	<i>Real</i>	2...30000	ms	1 = 1 ms
23.32	Shape time 1	<i>Real</i>	0.000...1800.000	s	1000 = 1 s
23.33	Shape time 2	<i>Real</i>	0.000...1800.000	s	1000 = 1 s
<b>24 Speed reference conditioning</b>					
24.01	Used speed reference	<i>Real</i>	-30000.00...30000.00	rpm	100 = 1 rpm
24.02	Used speed feedback	<i>Real</i>	-30000.00...30000.00	rpm	100 = 1 rpm
24.03	Speed error filtered	<i>Real</i>	-30000.0...30000.0	rpm	100 = 1 rpm
24.04	Speed error inverted	<i>Real</i>	-30000.0...30000.0	rpm	100 = 1 rpm
24.11	Speed correction	<i>Real</i>	-10000.00...10000.00	rpm	100 = 1 rpm
24.12	Speed error filter time	<i>Real</i>	0...10000	ms	1 = 1 ms
<b>25 Speed control</b>					
25.01	Torque reference speed control	<i>Real</i>	-1600.0...1600.0	%	10 = 1%
25.02	Speed proportional gain	<i>Real</i>	0.00...250.00	-	100 = 1
25.03	Speed integration time	<i>Real</i>	0.00...1000.00	s	1000 = 1 s
25.04	Speed derivation time	<i>Real</i>	0.000...10.000	s	1000 = 1 s
25.05	Derivation filter time	<i>Real</i>	0...10000	ms	1 = 1 ms
25.06	Acc comp derivation time	<i>Real</i>	0.00...1000.00	s	100 = 1 s
25.07	Acc comp filter time	<i>Real</i>	0.0...1000.0	ms	10 = 1 ms
25.15	Proportional gain em stop	<i>Real</i>	1.00...250.00	-	100 = 1
25.33	Speed controller autotune	<i>List</i>	0...1	-	1 = 1
25.34	Speed controller autotune mode	<i>List</i>	0...2	-	1 = 1
25.37	Mechanical time constant	<i>Real</i>	0.00...1000.00	s	100 = 1 s
25.38	Autotune torque step	<i>Real</i>	0.00...100.00	%	100 = 1%
25.39	Autotune speed step	<i>Real</i>	0.00...100.00	%	100 = 1%
25.40	Autotune repeat times	<i>Real</i>	1...10	-	1 = 1
25.53	Torque prop reference	<i>Real</i>	-30000.0...30000.0	%	10 = 1%
25.54	Torque integral reference	<i>Real</i>	-30000.0...30000.0	%	10 = 1%
25.55	Torque deriv reference	<i>Real</i>	-30000.0...30000.0	%	10 = 1%
25.56	Torque acc compensation	<i>Real</i>	-30000.0...30000.0	%	10 = 1%
<b>26 Torque reference chain</b>					
26.01	Torque reference to TC	<i>Real</i>	-1600.0...1600.0	%	10 = 1%
26.02	Torque reference used	<i>Real</i>	-1600.0...1600.0	%	10 = 1%
26.08	Minimum torque ref	<i>Real</i>	-1000.0...0.0	%	10 = 1%

No.	Name	Type	Range	Unit	FbEq32
26.09	Maximum torque ref	<i>Real</i>	0.0...1000.0	%	10 = 1%
26.11	Torque ref1 source	<i>Analog src</i>	-	-	1 = 1
26.12	Torque ref2 source	<i>Analog src</i>	-	-	1 = 1
26.13	Torque ref1 function	<i>List</i>	0...5	-	1 = 1
26.14	Torque ref1/2 selection	<i>Binary src</i>	-	-	1 = 1
26.17	Torque ref filter time	<i>Real</i>	0.000...30.000	s	1000 = 1 s
26.18	Torque ramp up time	<i>Real</i>	0.000...60.000	s	1000 = 1 s
26.19	Torque ramp down time	<i>Real</i>	0.000...60.000	s	1000 = 1 s
26.20	Torque reversal	<i>List</i>	0...7, 18...20, 24...26	-	1 = 1
26.70	Torque reference act 1	<i>Real</i>	-1600.0...1600.0	%	10 = 1%
26.71	Torque reference act 2	<i>Real</i>	-1600.0...1600.0	%	10 = 1%
26.72	Torque reference act 3	<i>Real</i>	-1600.0...1600.0	%	10 = 1%
26.73	Torque reference act 4	<i>Real</i>	-1600.0...1600.0	%	10 = 1%
26.74	Torque ref ramp out	<i>Real</i>	-1600.0...1600.0	%	10 = 1%
26.75	Torque reference act 5	<i>Real</i>	-1600.0...1600.0	%	10 = 1%
26.76	Torque reference act 6	<i>Real</i>	-1600.0...1600.0	%	10 = 1%
26.81	Rush control gain	<i>Real</i>	0.0...10000.0	-	10 = 1
26.82	Rush control integration time	<i>Real</i>	0.0...10.0	s	10 = 1
<b>28 Frequency reference chain</b>					
28.01	Frequency ref ramp input	<i>Real</i>	-500.00...500.00	Hz	100 = 1 Hz
28.02	Frequency ref ramp output	<i>Real</i>	-500.00...500.00	Hz	100 = 1 Hz
28.11	Ext1 frequency ref1	<i>Analog src</i>	-	-	1 = 1
28.12	Ext1 frequency ref2	<i>Analog src</i>	-	-	1 = 1
28.13	Ext1 frequency function	<i>List</i>	0...5	-	1 = 1
28.15	Ext2 frequency ref1	<i>Analog src</i>	-	-	1 = 1
28.16	Ext2 frequency ref2	<i>Analog src</i>	-	-	1 = 1
28.17	Ext2 frequency function	<i>List</i>	0...5	-	1 = 1
28.21	Constant frequency function	<i>PB</i>	00b...11b	-	1 = 1
28.22	Constant frequency sel1	<i>Binary src</i>	-	-	1 = 1
28.23	Constant frequency sel2	<i>Binary src</i>	-	-	1 = 1
28.24	Constant frequency sel3	<i>Binary src</i>	-	-	1 = 1
28.26	Constant frequency 1	<i>Real</i>	-500.00...500.00	Hz	100 = 1 Hz
28.27	Constant frequency 2	<i>Real</i>	-500.00...500.00	Hz	100 = 1 Hz
28.28	Constant frequency 3	<i>Real</i>	-500.00...500.00	Hz	100 = 1 Hz

456 Additional parameter data

No.	Name	Type	Range	Unit	FbEq32
28.29	Constant frequency 4	<i>Real</i>	-500.00...500.00	Hz	100 = 1 Hz
28.30	Constant frequency 5	<i>Real</i>	-500.00...500.00	Hz	100 = 1 Hz
28.31	Constant frequency 6	<i>Real</i>	-500.00...500.00	Hz	100 = 1 Hz
28.32	Constant frequency 7	<i>Real</i>	-500.00...500.00	Hz	100 = 1 Hz
28.41	Frequency ref safe	<i>Real</i>	-500.00...500.00	Hz	100 = 1 Hz
28.42	Jogging 1 frequency ref	<i>Real</i>	-500.00...500.00	Hz	100 = 1 Hz
28.43	Jogging 2 frequency ref	<i>Real</i>	-500.00...500.00	Hz	100 = 1 Hz
28.51	Critical frequency function	<i>PB</i>	00b...11b	-	1 = 1
28.52	Critical frequency 1 low	<i>Real</i>	-500.00...500.00	Hz	100 = 1 Hz
28.53	Critical frequency 1 high	<i>Real</i>	-500.00...500.00	Hz	100 = 1 Hz
28.54	Critical frequency 2 low	<i>Real</i>	-500.00...500.00	Hz	100 = 1 Hz
28.55	Critical frequency 2 high	<i>Real</i>	-500.00...500.00	Hz	100 = 1 Hz
28.56	Critical frequency 3 low	<i>Real</i>	-500.00...500.00	Hz	100 = 1 Hz
28.57	Critical frequency 3 high	<i>Real</i>	-500.00...500.00	Hz	100 = 1 Hz
28.71	Freq ramp set selection	<i>Binary src</i>	-	-	1 = 1
28.72	Freq acceleration time 1	<i>Real</i>	0.000...1800.000	s	1000 = 1 s
28.73	Freq deceleration time 1	<i>Real</i>	0.000...1800.000	s	1000 = 1 s
28.74	Freq acceleration time 2	<i>Real</i>	0.000...1800.000	s	1000 = 1 s
28.75	Freq deceleration time 2	<i>Real</i>	0.000...1800.000	s	1000 = 1 s
28.76	Freq ramp in zero source	<i>Binary src</i>	-	-	1 = 1
28.82	Shape time 1	<i>Real</i>	0.000...1800.000	s	1000 = 1 s
28.83	Shape time 2	<i>Real</i>	0.000...1800.000	s	1000 = 1 s
28.92	Frequency ref act 3	<i>Real</i>	-500.00...500.00	Hz	100 = 1 Hz
28.96	Frequency ref act 7	<i>Real</i>	-500.00...500.00	Hz	100 = 1 Hz
28.97	Frequency ref unlimited	<i>Real</i>	-500.00...500.00	Hz	100 = 1 Hz
<b>30 Limits</b>					
30.01	Limit word 1	<i>PB</i>	0000h...FFFFh	-	1 = 1
30.02	Torque limit status	<i>PB</i>	0000h...FFFFh	-	1 = 1
30.11	Minimum speed	<i>Real</i>	-30000.00...30000.00	rpm	100 = 1 rpm
30.12	Maximum speed	<i>Real</i>	-30000.00...30000.00	rpm	100 = 1 rpm
30.13	Minimum frequency	<i>Real</i>	-500.00...500.00	Hz	100 = 1 Hz
30.14	Maximum frequency	<i>Real</i>	-500.00...500.00	Hz	100 = 1 Hz
30.17	Maximum current	<i>Real</i>	0.00...30000.00	A	100 = 1 A
30.18	Torq lim sel	<i>Binary src</i>	-	-	1 = 1
30.19	Minimum torque 1	<i>Real</i>	-1600.0...0.0	%	10 = 1%
30.20	Maximum torque 1	<i>Real</i>	0.0...1600.0	%	10 = 1%
30.21	Min torque 2 source	<i>Analog src</i>	-	-	1 = 1
30.22	Max torque 2 source	<i>Analog src</i>	-	-	1 = 1



No.	Name	Type	Range	Unit	FbEq32
30.23	Minimum torque 2	<i>Real</i>	-1600.0...0.0	%	10 = 1%
30.24	Maximum torque 2	<i>Real</i>	0.0...1600.0	%	10 = 1%
30.26	Power motoring limit	<i>Real</i>	0.00...600.00	%	100 = 1%
30.27	Power generating limit	<i>Real</i>	-600.00...0.00	%	100 = 1%
30.30	Overvoltage control	<i>List</i>	0...1	-	1 = 1
30.31	Undervoltage control	<i>List</i>	0...1	-	1 = 1
30.35	Thermal current limitation	<i>List</i>	0...1	-	1 = 1
30.36	Speed limit selection	<i>Binary src</i>	-	-	1 = 1
30.37	Minimum speed source	<i>Analog src</i>	-	-	1 = 1
30.38	Maximum speed source	<i>Analog src</i>	-	-	1 = 1
<b>31 Fault functions</b>					
31.01	External event 1 source	<i>Binary src</i>	-	-	1 = 1
31.02	External event 1 type	<i>List</i>	0...1	-	1 = 1
31.03	External event 2 source	<i>Binary src</i>	-	-	1 = 1
31.04	External event 2 type	<i>List</i>	0...1	-	1 = 1
31.05	External event 3 source	<i>Binary src</i>	-	-	1 = 1
31.06	External event 3 type	<i>List</i>	0...1	-	1 = 1
31.07	External event 4 source	<i>Binary src</i>	-	-	1 = 1
31.08	External event 4 type	<i>List</i>	0...1	-	1 = 1
31.09	External event 5 source	<i>Binary src</i>	-	-	1 = 1
31.10	External event 5 type	<i>List</i>	0...1	-	1 = 1
31.11	Fault reset selection	<i>Binary src</i>	-	-	1 = 1
31.12	Autoreset selection	<i>PB</i>	0000h...FFFFh	-	1 = 1
31.13	Selectable fault	<i>Real</i>	0000h...FFFFh	-	1 = 1
31.14	Number of trials	<i>Real</i>	0..5	-	1 = 1
31.15	Total trials time	<i>Real</i>	1.0...600.0	s	10 = 1 s
31.16	Delay time	<i>Real</i>	0.0...120.0	s	10 = 1 s
31.19	Motor phase loss	<i>List</i>	0...1	-	1 = 1
31.21	Supply phase loss	<i>List</i>	0...1	-	1 = 1
31.22	STO indication run/stop	<i>List</i>	0..5	-	1 = 1
31.23	Wiring or earth fault	<i>List</i>	0...1	-	1 = 1
31.24	Stall function	<i>List</i>	0...1	-	1 = 1
31.25	Stall current limit	<i>Real</i>	0.0...1600.0	%	10 = 1%
31.26	Stall speed limit	<i>Real</i>	0.00...10000.00	rpm	100 = 1 rpm
31.27	Stall frequency limit	<i>Real</i>	0.00...1000.00	Hz	100 = 1 Hz

458 Additional parameter data

No.	Name	Type	Range	Unit	FbEq32
31.28	Stall time	<i>Real</i>	0...3600	s	1 = 1 s
31.30	Overspeed trip margin	<i>Real</i>	0.00...10000.00	rpm	100 = 1 rpm
31.31	Frequency trip margin	<i>Real</i>	0.00...10000.0	Hz	100 = 1 Hz
31.32	Emergency ramp supervision	<i>Real</i>	0...300	%	1 = 1%
31.33	Emergency ramp supervision delay	<i>Real</i>	0...100	s	1 = 1 s
31.35	Main fan fault function	<i>List</i>	0...2	-	1 = 1
31.36	Aux fan fault function	<i>List</i>	0...2	-	1 = 1
31.40	Disable warning messages	<i>PB</i>	0000h...FFFFh	-	1 = 1
31.54	Fault action	<i>List</i>	0...1	-	1 = 1
<b>32 Supervision</b>					
32.01	Supervision status	<i>PB</i>	0000h...FFFFh	-	1 = 1
32.05	Supervision 1 function	<i>List</i>	0...7	-	1 = 1
32.06	Supervision 1 action	<i>List</i>	0...3	-	1 = 1
32.07	Supervision 1 signal	<i>Analog src</i>	-	-	1 = 1
32.08	Supervision 1 filter time	<i>Real</i>	0.000...30.000	s	1000 = 1 s
32.09	Supervision 1 low	<i>Real</i>	-21474836.00... 21474836.00	-	100 = 1
32.10	Supervision 1 high	<i>Real</i>	-21474836.00... 21474836.00	-	100 = 1
32.11	Supervision 1 hysteresis	<i>Real</i>	0.00...100000.00	-	100 = 1
32.15	Supervision 2 function	<i>List</i>	0...7	-	1 = 1
32.16	Supervision 2 action	<i>List</i>	0...3	-	1 = 1
32.17	Supervision 2 signal	<i>Analog src</i>	-	-	1 = 1
32.18	Supervision 2 filter time	<i>Real</i>	0.000...30.000	s	1000 = 1 s
32.19	Supervision 2 low	<i>Real</i>	-21474836.00... 21474836.00	-	100 = 1
32.20	Supervision 2 high	<i>Real</i>	-21474836.00... 21474836.00	-	100 = 1
32.21	Supervision 2 hysteresis	<i>Real</i>	0.00...100000.00	-	100 = 1
32.25	Supervision 3 function	<i>List</i>	0...7	-	1 = 1
32.26	Supervision 3 action	<i>List</i>	0...3	-	1 = 1
32.27	Supervision 3 signal	<i>Analog src</i>	-	-	1 = 1
32.28	Supervision 3 filter time	<i>Real</i>	0.000...30.000	s	1000 = 1 s
32.29	Supervision 3 low	<i>Real</i>	-21474836.00... 21474836.00	-	100 = 1
32.30	Supervision 3 high	<i>Real</i>	-21474836.00... 21474836.00	-	100 = 1
32.31	Supervision 3 hysteresis	<i>Real</i>	0.00...100000.00	-	100 = 1
32.35	Supervision 4 function	<i>List</i>	0...7	-	1 = 1
32.36	Supervision 4 action	<i>List</i>	0...3	-	1 = 1

No.	Name	Type	Range	Unit	FbEq32
32.37	Supervision 4 signal	<i>Analog src</i>	-	-	1 = 1
32.38	Supervision 4 filter time	<i>Real</i>	0.000...30.000	s	1000 = 1 s
32.39	Supervision 4 low	<i>Real</i>	-21474836.00... 21474836.00	-	100 = 1
32.40	Supervision 4 high	<i>Real</i>	-21474836.00... 21474836.00	-	100 = 1
32.41	Supervision 4 hysteresis	<i>Real</i>	0.00...100000.00	-	100 = 1
32.45	Supervision 5 function	<i>List</i>	0...7	-	1 = 1
32.46	Supervision 5 action	<i>List</i>	0...3	-	1 = 1
32.47	Supervision 5 signal	<i>Analog src</i>	-	-	1 = 1
32.48	Supervision 5 filter time	<i>Real</i>	0.000...30.000	s	1000 = 1 s
32.49	Supervision 5 low	<i>Real</i>	-21474836.00... 21474836.00	-	100 = 1
32.50	Supervision 5 high	<i>Real</i>	-21474836.00... 21474836.00	-	100 = 1
32.51	Supervision 5 hysteresis	<i>Real</i>	0.00...100000.00	-	100 = 1
32.55	Supervision 6 function	<i>List</i>	0...7	-	1 = 1
32.56	Supervision 6 action	<i>List</i>	0...3	-	1 = 1
32.57	Supervision 6 signal	<i>Analog src</i>	-	-	1 = 1
32.58	Supervision 6 filter time	<i>Real</i>	0.000...30.000	s	1000 = 1 s
32.59	Supervision 6 low	<i>Real</i>	-21474836.00... 21474836.00	-	100 = 1
32.60	Supervision 6 high	<i>Real</i>	-21474836.00... 21474836.00	-	100 = 1
32.61	Supervision 6 hysteresis	<i>Real</i>	0.00...100000.00	-	100 = 1
<b>34 Timed functions</b>					
34.01	Timed functions status	<i>PB</i>	0000h...FFFFh	-	1 = 1
34.02	Timer status	<i>PB</i>	0000h...FFFFh	-	1 = 1
34.04	Season/exception day status	<i>PB</i>	0000h...FFFFh	-	1 = 1
34.10	Timed functions enable	<i>Binary src</i>	-	-	1 = 1
34.11	Timer 1 configuration	<i>PB</i>	0000h...FFFFh	-	1 = 1
34.12	Timer 1 start time	Time	00:00:00...23:59:59	s	1 = 1 s
34.13	Timer 1 duration	Duration	00 00:00...07 00:00	min	1 = 1 min
34.14	Timer 2 configuration	<i>PB</i>	0000h...FFFFh	-	1 = 1
34.15	Timer 2 start time	Time	00:00:00...23:59:59	s	1 = 1 s
34.16	Timer 2 duration	Duration	00 00:00...07 00:00	min	1 = 1 min
34.17	Timer 3 configuration	<i>PB</i>	0000h...FFFFh	-	1 = 1
34.18	Timer 3 start time	Time	00:00:00...23:59:59	s	1 = 1 s
34.19	Timer 3 duration	Duration	00 00:00...07 00:00	min	1 = 1 min
34.20	Timer 4 configuration	<i>PB</i>	0000h...FFFFh	-	1 = 1

460 Additional parameter data

No.	Name	Type	Range	Unit	FbEq32
34.21	Timer 4 start time	Time	00:00:00...23:59:59	s	1 = 1 s
34.22	Timer 4 duration	Duration	00 00:00...07 00:00	min	1 = 1 min
34.23	Timer 5 configuration	<i>PB</i>	0000h...FFFFh	-	1 = 1
34.24	Timer 5 start time	Time	00:00:00...23:59:59	s	1 = 1 s
34.25	Timer 5 duration	Duration	00 00:00...07 00:00	min	1 = 1 min
34.26	Timer 6 configuration	<i>PB</i>	0000h...FFFFh	-	1 = 1
34.27	Timer 6 start time	Time	00:00:00...23:59:59	s	1 = 1 s
34.28	Timer 6 duration	Duration	00 00:00...07 00:00	min	1 = 1 min
34.29	Timer 7 configuration	<i>PB</i>	0000h...FFFFh	-	1 = 1
34.30	Timer 7 start time	Time	00:00:00...23:59:59	s	1 = 1 s
34.31	Timer 7 duration	Duration	00 00:00...07 00:00	min	1 = 1 min
34.32	Timer 8 configuration	<i>PB</i>	0000h...FFFFh	-	1 = 1
34.33	Timer 8 start time	Time	00:00:00...23:59:59	s	1 = 1 s
34.34	Timer 8 duration	Duration	00 00:00...07 00:00	min	1 = 1 min
34.35	Timer 9 configuration	<i>PB</i>	0000h...FFFFh	-	1 = 1
34.36	Timer 9 start time	Time	00:00:00...23:59:59	s	1 = 1 s
34.37	Timer 9 duration	Duration	00 00:00...07 00:00	min	1 = 1 min
34.38	Timer 10 configuration	<i>PB</i>	0000h...FFFFh	-	1 = 1
34.39	Timer 10 start time	Time	00:00:00...23:59:59	s	1 = 1 s
34.40	Timer 10 duration	Duration	00 00:00...07 00:00	min	1 = 1 min
34.41	Timer 11 configuration	<i>PB</i>	0000h...FFFFh	-	1 = 1
34.42	Timer 11 start time	Time	00:00:00...23:59:59	s	1 = 1 s
34.43	Timer 11 duration	Duration	00 00:00...07 00:00	min	1 = 1 min
34.44	Timer 12 configuration	<i>PB</i>	0000h...FFFFh	-	1 = 1
34.45	Timer 12 start time	Time	00:00:00...23:59:59	s	1 = 1 s
34.46	Timer 12 duration	Duration	00 00:00...07 00:00	min	1 = 1 min
34.60	Season 1 start date	Date	01.01...31.12	d	1 = 1 d
34.61	Season 2 start date	Date	01.01...31.12	d	1 = 1 d
34.62	Season 3 start date	Date	01.01...31.12	d	1 = 1 d
34.63	Season 4 start date	Date	01.01...31.12	d	1 = 1 d
34.70	Number of active exceptions	<i>Real</i>	0...16	-	1 = 1
34.71	Exception types	<i>PB</i>	0000h...FFFFh	-	1 = 1
34.72	Exception 1 start	Date	01.01...31.12	d	1 = 1 d
34.73	Exception 1 length	<i>Real</i>	0...60	d	1 = 1 d
34.74	Exception 2 start	Date	01.01...31.12	d	1 = 1 d
34.75	Exception 2 length	<i>Real</i>	0...60	d	1 = 1 d
34.76	Exception 3 start	Date	01.01...31.12	d	1 = 1 d
34.77	Exception 3 length	<i>Real</i>	0...60	d	1 = 1 d
34.78	Exception day 4	Date	01.01...31.12	d	1 = 1 d
34.79	Exception day 5	Date	01.01...31.12	d	1 = 1 d
34.80	Exception day 6	Date	01.01...31.12	d	1 = 1 d

No.	Name	Type	Range	Unit	FbEq32
34.81	Exception day 7	Date	01.01...31.12	d	1 = 1 d
34.82	Exception day 8	Date	01.01...31.12	d	1 = 1 d
34.83	Exception day 9	Date	01.01...31.12	d	1 = 1 d
34.84	Exception day 10	Date	01.01...31.12	d	1 = 1 d
34.85	Exception day 11	Date	01.01...31.12	d	1 = 1 d
34.86	Exception day 12	Date	01.01...31.12	d	1 = 1 d
34.87	Exception day 13	Date	01.01...31.12	d	1 = 1 d
34.88	Exception day 14	Date	01.01...31.12	d	1 = 1 d
34.89	Exception day 15	Date	01.01...31.12	d	1 = 1 d
34.90	Exception day 16	Date	01.01...31.12	d	1 = 1 d
34.100	Timed function 1	<i>PB</i>	0000h...FFFFh	-	1 = 1
34.101	Timed function 2	<i>PB</i>	0000h...FFFFh	-	1 = 1
34.102	Timed function 3	<i>PB</i>	0000h...FFFFh	-	1 = 1
34.110	Boost time function	<i>PB</i>	0000h...FFFFh	-	1 = 1
34.111	Boost time activation source	<i>Binary src</i>	-	-	1 = 1
34.112	Boost time duration	Duration	00 00:00...07 00:00	min	1 = 1 min
<b>35 Motor thermal protection</b>					
35.01	Motor estimated temperature	<i>Real</i>	-60...1000 °C or -76...1832 °F	°C or °F	1 = 1 °
35.02	Measured temperature 1	<i>Real</i>	-60...5000 °C or -76...9032 °F, 0 ohm or [35.12] ohm	°C, °F or ohm	1 = 1 unit
35.03	Measured temperature 2	<i>Real</i>	-60...5000 °C or -76...9032 °F, 0 ohm or [35.22] ohm	°C, °F or ohm	1 = 1 unit
35.05	Motor overload level	<i>Real</i>	0.0...300.0	%	10 = 1%
35.11	Temperature 1 source	<i>List</i>	0...2, 5...8, 11...16, 19, 21, 22	-	1 = 1
35.12	Temperature 1 fault limit	<i>Real</i>	-60...5000 °C or -76...9032 °F	°C, °F or ohm	1 = 1 unit
35.13	Temperature 1 warning limit	<i>Real</i>	-60...5000 °C or -76...9032 °F	°C, °F or ohm	1 = 1 unit
35.14	Temperature 1 AI source	<i>Analog src</i>	-	-	1 = 1
35.21	Temperature 2 source	<i>List</i>	0...2, 5...7, 11...16, 19	-	1 = 1
35.22	Temperature 2 fault limit	<i>Real</i>	-60...5000 °C or -76...9032 °F	°C, °F or ohm	1 = 1 unit
35.23	Temperature 2 warning limit	<i>Real</i>	-60...5000 °C or -76...9032 °F	°C, °F or ohm	1 = 1 unit
35.24	Temperature 2 AI source	<i>Analog src</i>	-	-	1 = 1
35.31	Safe motor temperature enable	<i>List</i>	0...1	-	1 = 1

462 Additional parameter data

No.	Name	Type	Range	Unit	FbEq32
35.50	Motor ambient temperature	<i>Real</i>	-60...100 °C or -76 ... 212 °F	°C	1 = 1 °
35.51	Motor load curve	<i>Real</i>	50...150	%	1 = 1%
35.52	Zero speed load	<i>Real</i>	25...150	%	1 = 1%
35.53	Break point	<i>Real</i>	1.00 ... 500.00	Hz	100 = 1 Hz
35.54	Motor nominal temperature rise	<i>Real</i>	0...300 °C or 32...572 °F	°C or °F	1 = 1 °
35.55	Motor thermal time constant	<i>Real</i>	100...10000	s	1 = 1 s
35.56	Motor overload action	<i>List</i>	0...1	-	1 = 1
35.57	Motor overload class	<i>List</i>	0...4	-	1 = 1
<b>36 Load analyzer</b>					
36.01	PVL signal source	<i>Analog src</i>	-	-	1 = 1
36.02	PVL filter time	<i>Real</i>	0.00...120.00	s	100 = 1 s
36.06	AL2 signal source	<i>Analog src</i>	-	-	1 = 1
36.07	AL2 signal scaling	<i>Real</i>	0.00...32767.00	-	100 = 1
36.09	Reset loggers	<i>List</i>	0...3	-	1 = 1
36.10	PVL peak value	<i>Real</i>	-32768.00...32767.00	-	100 = 1
36.11	PVL peak date	<i>Data</i>	-	-	1 = 1
36.12	PVL peak time	<i>Data</i>	-	-	1 = 1
36.13	PVL current at peak	<i>Real</i>	-32768.00...32767.00	A	100 = 1 A
36.14	PVL DC voltage at peak	<i>Real</i>	0.00...2000.00	V	100 = 1 V
36.15	PVL speed at peak	<i>Real</i>	-30000.00... 30000.00	rpm	100 = 1 rpm
36.16	PVL reset date	<i>Data</i>	-	-	1 = 1
36.17	PVL reset time	<i>Data</i>	-	-	1 = 1
36.20	AL1 0 to 10%	<i>Real</i>	0.00...100.00	%	100 = 1%
36.21	AL1 10 to 20%	<i>Real</i>	0.00...100.00	%	100 = 1%
36.22	AL1 20 to 30%	<i>Real</i>	0.00...100.00	%	100 = 1%
36.23	AL1 30 to 40%	<i>Real</i>	0.00...100.00	%	100 = 1%
36.24	AL1 40 to 50%	<i>Real</i>	0.00...100.00	%	100 = 1%
36.25	AL1 50 to 60%	<i>Real</i>	0.00...100.00	%	100 = 1%
36.26	AL1 60 to 70%	<i>Real</i>	0.00...100.00	%	100 = 1%
36.27	AL1 70 to 80%	<i>Real</i>	0.00...100.00	%	100 = 1%
36.28	AL1 80 to 90%	<i>Real</i>	0.00...100.00	%	100 = 1%
36.29	AL1 over 90%	<i>Real</i>	0.00...100.00	%	100 = 1%
36.40	AL2 0 to 10%	<i>Real</i>	0.00...100.00	%	100 = 1%
36.41	AL2 10 to 20%	<i>Real</i>	0.00...100.00	%	100 = 1%
36.42	AL2 20 to 30%	<i>Real</i>	0.00...100.00	%	100 = 1%
36.43	AL2 30 to 40%	<i>Real</i>	0.00...100.00	%	100 = 1%
36.44	AL2 40 to 50%	<i>Real</i>	0.00...100.00	%	100 = 1%
36.45	AL2 50 to 60%	<i>Real</i>	0.00...100.00	%	100 = 1%

No.	Name	Type	Range	Unit	FbEq32
36.46	AL2 60 to 70%	<i>Real</i>	0.00...100.00	%	100 = 1%
36.47	AL2 70 to 80%	<i>Real</i>	0.00...100.00	%	100 = 1%
36.48	AL2 80 to 90%	<i>Real</i>	0.00...100.00	%	100 = 1%
36.49	AL2 over 90%	<i>Real</i>	0.00...100.00	%	100 = 1%
36.50	AL2 reset date	<i>Data</i>	-	-	1 = 1
36.51	AL2 reset time	<i>Data</i>	-	-	1 = 1
<b>37 User load curve</b>					
37.01	ULC output status word	<i>PB</i>	0000h...FFFFh	-	1 = 1
37.02	ULC supervision signal	<i>Analog src</i>	-	-	1 = 1
37.03	ULC overload actions	<i>List</i>	0...3	-	1 = 1
37.04	ULC underload actions	<i>List</i>	0...3	-	1 = 1
37.11	ULC speed table point 1	<i>Real</i>	-30000.0...30000.0	rpm	10 = 1 rpm
37.12	ULC speed table point 2	<i>Real</i>	-30000.0...30000.0	rpm	10 = 1 rpm
37.13	ULC speed table point 3	<i>Real</i>	-30000.0...30000.0	rpm	10 = 1 rpm
37.14	ULC speed table point 4	<i>Real</i>	-30000.0...30000.0	rpm	10 = 1 rpm
37.15	ULC speed table point 5	<i>Real</i>	-30000.0...30000.0	rpm	10 = 1 rpm
37.16	ULC frequency table point 1	<i>Real</i>	-500.0...500.0	Hz	10 = 1 Hz
37.17	ULC frequency table point 2	<i>Real</i>	-500.0...500.0	Hz	10 = 1 Hz
37.18	ULC frequency table point 3	<i>Real</i>	-500.0...500.0	Hz	10 = 1 Hz
37.19	ULC frequency table point 4	<i>Real</i>	-500.0...500.0	Hz	10 = 1 Hz
37.20	ULC frequency table point 5	<i>Real</i>	-500.0...500.0	Hz	10 = 1 Hz
37.21	ULC underload point 1	<i>Real</i>	-1600.0...1600.0	%	10 = 1%
37.22	ULC underload point 2	<i>Real</i>	-1600.0...1600.0	%	10 = 1%
37.23	ULC underload point 3	<i>Real</i>	-1600.0...1600.0	%	10 = 1%
37.24	ULC underload point 4	<i>Real</i>	-1600.0...1600.0	%	10 = 1%
37.25	ULC underload point 5	<i>Real</i>	-1600.0...1600.0	%	10 = 1%
37.31	ULC overload point 1	<i>Real</i>	-1600.0...1600.0	%	10 = 1%
37.32	ULC overload point 2	<i>Real</i>	-1600.0...1600.0	%	10 = 1%
37.33	ULC overload point 3	<i>Real</i>	-1600.0...1600.0	%	10 = 1%
37.34	ULC overload point 4	<i>Real</i>	-1600.0...1600.0	%	10 = 1%
37.35	ULC overload point 5	<i>Real</i>	-1600.0...1600.0	%	10 = 1%
37.41	ULC overload timer	<i>Real</i>	0.0...10000.0	s	10 = 1 s
37.42	ULC underload timer	<i>Real</i>	0.0...10000.0	s	10 = 1 s
<b>40 Process PID set 1</b>					
40.01	Process PID output actual	<i>Real</i>	-200000.00...200000.00	%	100 = 1 PID customer unit
40.02	Process PID feedback actual	<i>Real</i>	-200000.00...200000.00	PID customer units	100 = 1 PID customer unit
40.03	Process PID setpoint actual	<i>Real</i>	-200000.00...200000.00	PID customer units	100 = 1 PID customer unit

464 Additional parameter data

No.	Name	Type	Range	Unit	FbEq32
40.04	Process PID deviation actual	<i>Real</i>	-200000.00...200000.00	PID customer units	100 = 1 PID customer unit
40.05	Process PID trim output act	<i>Real</i>	-32768...32768	-	1 = 1
40.06	Process PID status word	<i>PB</i>	0000h...FFFFh	-	1 = 1
40.07	Process PID operation mode	<i>List</i>	0...2	-	1 = 1
40.08	Set 1 feedback 1 source	<i>Analog src</i>	-	-	1 = 1
40.09	Set 1 feedback 2 source	<i>Analog src</i>	-	-	1 = 1
40.10	Set 1 feedback function	<i>List</i>	0...11	-	1 = 1
40.11	Set 1 feedback filter time	<i>Real</i>	0.000...30.000	s	1000 = 1 s
40.14	Set 1 setpoint scaling	<i>Real</i>	-200000.00...200000.00	-	100 = 1
40.15	Set 1 output scaling	<i>Real</i>	-200000.00...200000.00	-	100 = 1
40.16	Set 1 setpoint 1 source	<i>Analog src</i>	-	-	1 = 1
40.17	Set 1 setpoint 2 source	<i>Analog src</i>	-	-	1 = 1
40.18	Set 1 setpoint function	<i>List</i>	0...11	-	1 = 1
40.19	Set 1 internal setpoint sel1	<i>Binary src</i>	-	-	1 = 1
40.20	Set 1 internal setpoint sel2	<i>Binary src</i>	-	-	1 = 1
40.21	Set 1 internal setpoint 1	<i>Real</i>	-200000.00...200000.00	PID customer units	100 = 1 PID customer unit
40.22	Set 1 internal setpoint 2	<i>Real</i>	-200000.00...200000.00	PID customer units	100 = 1 PID customer unit
40.23	Set 1 internal setpoint 3	<i>Real</i>	-200000.00...200000.00	PID customer units	100 = 1 PID customer unit
40.24	Set 1 internal setpoint 0	<i>Real</i>	-200000.00...200000.00	PID customer units	100 = 1 PID customer unit
40.26	Set 1 setpoint min	<i>Real</i>	-200000.00...200000.00	PID customer units	100 = 1 PID customer unit
40.27	Set 1 setpoint max	<i>Real</i>	-200000.00...200000.00	PID customer units	100 = 1 PID customer unit
40.28	Set 1 setpoint increase time	<i>Real</i>	0.0...1800.0	s	10 = 1 s
40.29	Set 1 setpoint decrease time	<i>Real</i>	0.0...1800.0	s	10 = 1 s
40.30	Set 1 setpoint freeze enable	<i>Binary src</i>	-	-	1 = 1
40.31	Set 1 deviation inversion	<i>Binary src</i>	-	-	1 = 1
40.32	Set 1 gain	<i>Real</i>	0.01...100.00	-	100 = 1



No.	Name	Type	Range	Unit	FbEq32
40.33	Set 1 integration time	<i>Real</i>	0.0...9999.0	s	10 = 1 s
40.34	Set 1 derivation time	<i>Real</i>	0.000...10.000	s	1000 = 1 s
40.35	Set 1 derivation filter time	<i>Real</i>	0.0...10.0	s	10 = 1 s
40.36	Set 1 output min	<i>Real</i>	-200000.00...200000.00	-	100 = 1
40.37	Set 1 output max	<i>Real</i>	-200000.00...200000.00	-	100 = 1
40.38	Set 1 output freeze enable	<i>Binary src</i>	-	-	1 = 1
40.39	Set 1 deadband range	<i>Real</i>	0.....200000.0	PID customer units	10 = 1 PID customer unit
40.40	Set 1 deadband delay	<i>Real</i>	0.0 ... 3600.0	s	10 = 1 s
40.43	Set 1 sleep level	<i>Real</i>	0.0...200000.0	-	10 = 1
40.44	Set 1 sleep delay	<i>Real</i>	0.0...3600.0	s	10 = 1 s
40.45	Set 1 sleep boost time	<i>Real</i>	0.0...3600.0	s	10 = 1 s
40.46	Set 1 sleep boost step	<i>Real</i>	0.0...200000.0	PID customer units	10 = 1 PID customer unit
40.47	Set 1 wake-up deviation	<i>Real</i>	-200000.00...200000.00	PID customer units	100 = 1 PID customer unit
40.48	Set 1 wake-up delay	<i>Real</i>	0.00...60.00	s	100 = 1 s
40.49	Set 1 tracking mode	<i>Binary src</i>	-	-	1 = 1
40.50	Set 1 tracking ref selection	<i>Analog src</i>	-	-	1 = 1
40.51	Set 1 trim mode	<i>List</i>	0...3	-	1 = 1
40.52	Set 1 trim selection	<i>List</i>	1...3	-	1 = 1
40.53	Set 1 trimmed ref pointer	<i>Binary src</i>	-	-	1 = 1
40.54	Set 1 trim mix	<i>Real</i>	0.000 ... 1.000	-	1000 = 1
40.55	Set 1 trim adjust	<i>Real</i>	-100.000 ... 100.000	-	1000 = 1
40.56	Set 1 trim source	<i>List</i>	1...2	-	1 = 1
40.57	PID set1/set2 selection	<i>Binary src</i>	-	-	1 = 1
40.58	Set 1 increase prevention	<i>Binary src</i>	-	-	1 = 1
40.59	Set 1 decrease prevention	<i>Binary src</i>	-	-	1 = 1
40.60	Set 1 PID activation source	<i>Binary src</i>	-	-	1 = 1
40.61	Setpoint scaling actual	<i>Real</i>	-200000.00...200000.00	-	100 = 1
40.62	PID internal setpoint actual	<i>Real</i>	-200000.00...200000.00	PID customer units	100 = 1 PID customer unit
40.65	Trim auto connection	<i>List</i>	0...1	-	1 = 1

466 Additional parameter data

No.	Name	Type	Range	Unit	FbEq32
40.70	Compensated setpoint	<i>Real</i>	-200000.00...200000.00	PID customer units	100 = 1 PID customer unit
40.79	Set 1 units	<i>List</i>	-	-	1 = 1
40.80	Set 1 PID output min source	<i>List</i>	0...1	-	1 = 1
40.81	Set 1 PID output max source	<i>List</i>	0...1	-	1 = 1
40.89	Set 1 setpoint multiplier	<i>Real</i>	-200000.00...200000.00	-	100 = 1
40.90	Set 1 feedback multiplier	<i>Real</i>	-200000.00...200000.00	-	100 = 1
40.91	Feedback data storage	<i>Real</i>	-327.68...327.67	-	100 = 1
40.92	Setpoint data storage	<i>Real</i>	-327.68...327.67	-	100 = 1
40.96	Process PID output %	<i>Real</i>	-100.00...100.00	%	100 = 1
40.97	Process PID feedback %	<i>Real</i>	-100.00...100.00	%	100 = 1
40.98	Process PID setpoint %	<i>Real</i>	-100.00...100.00	%	100 = 1
40.99	Process PID deviation %	<i>Real</i>	-100.00...100.00	%	100 = 1
<b>41 Process PID set 2</b>					
41.08	Set 2 feedback 1 source	<i>Analog src</i>	-	-	1 = 1
41.09	Set 2 feedback 2 source	<i>Analog src</i>	-	-	1 = 1
41.10	Set 2 feedback function	<i>List</i>	0...11	-	1 = 1
41.11	Set 2 feedback filter time	<i>Real</i>	0.000...30.000	s	1000 = 1 s
41.14	Set 2 setpoint scaling	<i>Real</i>	-200000.00...200000.00	-	100 = 1
41.15	Set 2 output scaling	<i>Real</i>	-200000.00...200000.00	-	100 = 1
41.16	Set 2 setpoint 1 source	<i>Analog src</i>	-	-	1 = 1
41.17	Set 2 setpoint 2 source	<i>Analog src</i>	-	-	1 = 1
41.18	Set 2 setpoint function	<i>List</i>	0...13	-	1 = 1
41.19	Set 2 internal setpoint sel1	<i>Binary src</i>	-	-	1 = 1
41.20	Set 2 internal setpoint sel2	<i>Binary src</i>	-	-	1 = 1
41.21	Set 2 internal setpoint 1	<i>Real</i>	-200000.00...200000.00	PID customer unit	100 = 1 PID customer unit
41.22	Set 2 internal setpoint 2	<i>Real</i>	-200000.00...200000.00	PID customer units	100 = 1 PID customer unit
41.23	Set 2 internal setpoint 3	<i>Real</i>	-200000.00...200000.00	PID customer units	100 = 1 PID customer unit
41.24	Set 2 internal setpoint 0	<i>Real</i>	-200000.00...200000.00	PID customer units	100 = 1 PID customer unit
41.26	Set 2 setpoint min	<i>Real</i>	-200000.00...200000.00	PID customer units	100 = 1 PID customer unit

No.	Name	Type	Range	Unit	FbEq32
41.27	Set 2 setpoint max	<i>Real</i>	-200000.00...200000.00	PID customer units	100 = 1 PID customer unit
41.28	Set 2 setpoint increase time	<i>Real</i>	0.0...1800.0	s	10 = 1 s
41.29	Set 2 setpoint decrease time	<i>Real</i>	0.0...1800.0	s	10 = 1 s
41.30	Set 2 setpoint freeze enable	<i>Binary src</i>	-	-	1 = 1
41.31	Set 2 deviation inversion	<i>Binary src</i>	-	-	1 = 1
41.32	Set 2 gain	<i>Real</i>	0.10...100.00	-	100 = 1
41.33	Set 2 integration time	<i>Real</i>	0.0...9999.0	s	10 = 1 s
41.34	Set 2 derivation time	<i>Real</i>	0.000...10.000	s	1000 = 1 s
41.35	Set 2 derivation filter time	<i>Real</i>	0.0...10.0	s	10 = 1 s
41.36	Set 2 output min	<i>Real</i>	-200000.00...200000.00	-	100 = 1
41.37	Set 2 output max	<i>Real</i>	-200000.00...200000.00	-	100 = 1
41.38	Set 2 output freeze enable	<i>Binary src</i>	-	-	1 = 1
41.39	Set 2 deadband range	<i>Real</i>	0.....200000.0	-	10 = 1 PID customer unit
41.40	Set 2 deadband delay	<i>Real</i>	0.0 ... 3600.0	s	10 = 1 s
41.43	Set 2 sleep level	<i>Real</i>	0.0...200000.0	-	10 = 1
41.44	Set 2 sleep delay	<i>Real</i>	0.0...3600.0	s	10 = 1 s
41.45	Set 2 sleep boost time	<i>Real</i>	0.0...3600.0	s	10 = 1 s
41.46	Set 2 sleep boost step	<i>Real</i>	0.0...200000.0	PID customer units	10 = 1 PID customer unit
41.47	Set 2 wake-up deviation	<i>Real</i>	-200000.00...200000.00	PID customer units	100 = 1 PID customer unit
41.48	Set 2 wake-up delay	<i>Real</i>	0.00...60.00	s	100 = 1 s
41.49	Set 2 tracking mode	<i>Binary src</i>	-	-	1 = 1
41.50	Set 2 tracking ref selection	<i>Analog src</i>	-	-	1 = 1
41.51	Set 2 trim mode	<i>List</i>	0...3	-	1 = 1
41.52	Set 2 trim selection	<i>List</i>	1...3	-	1 = 1
41.53	Set 2 trimmed ref pointer	<i>Analog src</i>	-	-	1 = 1
41.54	Set 2 trim mix	<i>Real</i>	0.000 ... 1.000	-	1000 = 1
41.55	Set 2 trim adjust	<i>Real</i>	-100.000 ... 100.000	-	1000 = 1
41.56	Set 2 trim source	<i>List</i>	1...2	-	1 = 1
41.58	Set 2 increase prevention	<i>Binary src</i>	-	-	1 = 1
41.59	Set 2 decrease prevention	<i>Binary src</i>	-	-	1 = 1

No.	Name	Type	Range	Unit	FbEq32
41.60	Set 2 PID activation source	<i>Binary src</i>	-	-	1 = 1
41.79	Set 2 units	<i>List</i>	-	-	1 = 1
41.80	Set 2 PID output min source	<i>List</i>	0...1	-	1 = 1
41.81	Set 2 PID output max source	<i>List</i>	0...1	-	1 = 1
41.89	Set 2 setpoint multiplier	<i>Real</i>	-200000.00...200000.00	-	100 = 1
41.90	Set 2 feedback multiplier	<i>Real</i>	-200000.00...200000.00	-	100 = 1
<b>43 Brake chopper</b>					
43.01	Braking resistor temperature	<i>Real</i>	0.0...120.0	%	10 = 1%
43.06	Brake chopper function	<i>List</i>	0...3	-	1 = 1
43.07	Brake chopper run enable	<i>Binary src</i>	-	-	1 = 1
43.08	Brake resistor thermal tc	<i>Real</i>	0...10000	s	1 = 1 s
43.09	Brake resistor Pmax cont	<i>Real</i>	0.00...10000.00	kW	100 = 1 kW
43.10	Brake resistance	<i>Real</i>	0.0...1000.0	Ohm	10 = 1 ohm
43.11	Brake resistor fault limit	<i>Real</i>	0...150	%	1 = 1%
43.12	Brake resistor warning limit	<i>Real</i>	0...150	%	1 = 1%
<b>44 Mechanical brake control</b>					
44.01	Brake control status	<i>PB</i>	0000h...FFFFh	-	1 = 1
44.06	Brake control enable	<i>Binary src</i>	-	-	1 = 1
44.08	Brake open delay	<i>Real</i>	0.00...5.00	s	100 = 1 s
44.13	Brake close delay	<i>Real</i>	0.00...60.00	s	100 = 1 s
44.14	Brake close level	<i>Real</i>	0.00...1000.00	rpm	100 = 1 rpm
<b>45 Energy efficiency</b>					
45.01	Saved GW hours	<i>Real</i>	0...65535	GWh	1 = 1 GWh
45.02	Saved MW hours	<i>Real</i>	0...999	MWh	1 = 1 MWh
45.03	Saved kW hours	<i>Real</i>	0.0...999.9	kWh	10 = 1 kWh
45.04	Saved energy	<i>Real</i>	0.0...214748364.0	kWh	10 = 1 kWh
45.05	Saved money x1000	<i>Real</i>	0...4294967295 thousands	(defina- ble)	1 = 1 currency unit
45.06	Saved money	<i>Real</i>	0.00...999.99	(defina- ble)	100 = 1 currency unit
45.07	Saved amount	<i>Real</i>	0.00...21474830.00	(defina- ble)	100 = 1 currency unit
45.08	CO2 reduction in kilotons	<i>Real</i>	0...65535	metric kiloton	1 = 1 metric kiloton
45.09	CO2 reduction in tons	<i>Real</i>	0.0...999.9	metric ton	10 = 1 metric ton
45.10	Total saved CO2	<i>Real</i>	0.0...214748300.8	metric ton	10 = 1 metric ton
45.11	Energy optimizer	<i>List</i>	0...1	-	1 = 1
45.12	Energy tariff 1	<i>Real</i>	0.000...4294966.296	(defina- ble)	1000 = 1 currency unit

No.	Name	Type	Range	Unit	FbEq32
45.13	Energy tariff 2	<i>Real</i>	0.000...4294966.296	(defina- ble)	1000 = 1 currency unit
45.14	Tariff selection	<i>Binary src</i>	-	-	1 = 1
45.18	CO2 conversion factor	<i>Real</i>	0.000...65.535	tn/ MWh	1000 = 1 tn/MWh
45.19	Comparison power	<i>Real</i>	0.00...10000000.00	kW	10 = 1 kW
45.21	Energy calculations reset	<i>List</i>	0...1	-	1 = 1
45.24	Hourly peak power value	<i>Real</i>	-3000.00 ... 3000.00	kW	1 = 1 kW
45.25	Hourly peak power time	<i>Real</i>			N/A
45.26	Hourly total energy (resettable)	<i>Real</i>	-3000.00 ... 3000.00	kWh	1 = 1 kWh
45.27	Daily peak power value (resettable)	<i>Real</i>	-3000.00 ... 3000.00	kW	1 = 1 kW
45.28	Daily peak power time	<i>Real</i>			N/A
45.29	Daily total energy (resettable)	<i>Real</i>	-30000.00 ... 30000.00	kWh	1 = 1 kWh
45.30	Last day total energy	<i>Real</i>	-30000.00 ... 30000.00	kWh	1 = 1 kWh
45.31	Monthly peak power value (resettable)	<i>Real</i>	-3000.00 ... 3000.00	kW	1 = 1 kW
45.32	Monthly peak power date	<i>Real</i>	-		N/A
45.33	Monthly peak power time	<i>Real</i>	-		N/A
45.34	Monthly total energy (resettable)	<i>Real</i>	-1000000.00 ... 1000000.00	kWh	1 = 1 kWh
45.35	Last month total energy	<i>Real</i>	-1000000.00 ... 1000000.00	kWh	1 = 1 kWh
45.36	Lifetime peak power value	<i>Real</i>	-3000.00 ... 3000.00	kW	1 = 1 kW
45.37	Lifetime peak power date	<i>Real</i>			N/A
45.38	Lifetime peak power time	<i>Real</i>	-		N/A
<b>46 Monitoring/scaling settings</b>					
46.01	Speed scaling	<i>Real</i>	0.00...30000.00	rpm	100 = 1 rpm
46.02	Frequency scaling	<i>Real</i>	0.10...1000.00	Hz	100 = 1 Hz
46.03	Torque scaling	<i>Real</i>	0.1...1000.0	%	10 = 1%
46.04	Power scaling	<i>Real</i>	0.10...30000.00	-	10 = 1
46.05	Current scaling	<i>Real</i>	0...30000	A	1 = 1 A
46.06	Speed ref zero scaling	<i>Real</i>	0.00 ... 30000.00	rpm	100 = 1 rpm
46.07	Frequency ref zero scaling	<i>Real</i>	0.00...1000.00	Hz	100 = 1 Hz
46.11	Filter time motor speed	<i>Real</i>	2...20000	ms	1 = 1 ms
46.12	Filter time output frequency	<i>Real</i>	2...20000	ms	1 = 1 ms
46.13	Filter time motor torque	<i>Real</i>	2...20000	ms	1 = 1 ms
46.14	Filter time power	<i>Real</i>	2...20000	ms	1 = 1 ms
46.21	At speed hysteresis	<i>Real</i>	0.00...30000.00	rpm	100 = 1 rpm
46.22	At frequency hysteresis	<i>Real</i>	0.00...1000.00	Hz	100 = 1 Hz
46.23	At torque hysteresis	<i>Real</i>	0.0...300.0	%	1 = 1%
46.31	Above speed limit	<i>Real</i>	0.00...30000.00	rpm	100 = 1 rpm

470 Additional parameter data

No.	Name	Type	Range	Unit	FbEq32
46.32	Above frequency limit	<i>Real</i>	0.00...1000.00	Hz	100 = 1 Hz
46.33	Above torque limit	<i>Real</i>	0.0...1600.0	%	10 = 1%
46.41	kWh pulse scaling	<i>Real</i>	0.001...1000.000	kWh	1000 = 1 kWh
46.43	Power decimals	<i>Real</i>	0...3	-	1 = 1
46.44	Current decimals	<i>Real</i>	0...3	-	1 = 1
<b>47 Data storage</b>					
47.01	Data storage 1 real32	<i>Real</i>	-2147483.000... 2147483.000	-	1000 = 1
47.02	Data storage 2 real32	<i>Real</i>	-2147483.000... 2147483.000	-	1000 = 1
47.03	Data storage 3 real32	<i>Real</i>	-2147483.000... 2147483.000	-	1000 = 1
47.04	Data storage 4 real32	<i>Real</i>	-2147483.000... 2147483.000	-	1000 = 1
47.11	Data storage 1 int32	<i>Real</i>	-2147483648... 2147483647	-	1 = 1
47.12	Data storage 2 int32	<i>Real</i>	-2147483648... 2147483647	-	1 = 1
47.13	Data storage 3 int32	<i>Real</i>	-2147483648... 2147483647	-	1 = 1
47.14	Data storage 4 int32	<i>Real</i>	-2147483648... 2147483647	-	1 = 1
47.21	Data storage 1 int16	<i>Real</i>	-32768...32767	-	1 = 1
47.22	Data storage 2 int16	<i>Real</i>	-32768...32767	-	1 = 1
47.23	Data storage 3 int16	<i>Real</i>	-32768...32767	-	1 = 1
47.24	Data storage 4 int16	<i>Real</i>	-32768...32767	-	1 = 1
<b>49 Panel port communication</b>					
49.01	Node ID number	<i>Real</i>	1...32	-	1 = 1
49.03	Baud rate	<i>List</i>	1...5	-	1 = 1
49.04	Communication loss time	<i>Real</i>	0.3...3000.0	s	10 = 1 s
49.05	Communication loss action	<i>List</i>	0...3	-	1 = 1
49.06	Refresh settings	<i>List</i>	0...1	-	1 = 1
49.19	Basic panel home view 1	<i>List</i>	0, 1, 10...12, 14,16, 20, 21, 26...28, 30...33, 37...38	-	1 = 1
49.20	Basic panel home view 2	<i>List</i>	0, 1, 10...12, 14,16, 20, 21, 26...28, 30...33, 37...38	-	1 =
49.21	Basic panel home view 3	<i>List</i>	0, 1, 10...12, 14,16, 20, 21, 26...28, 30...33, 37...38	-	1 = 1
49.219	Basic panel home view 4	<i>List</i>	0, 1, 10...12, 14,16, 20, 21, 26...28, 30...33, 37...38	-	1 = 1
49.220	Basic panel home view 5	<i>List</i>	0, 1, 10...12, 14,16, 20, 21, 26...28, 30...33, 37...38	-	1 = 1
49.221	Basic panel home view 6	<i>List</i>	0, 1, 10...12, 14,16, 20, 21, 26...28, 30...33, 37...38	-	1 = 1

No.	Name	Type	Range	Unit	FbEq32
<b>50 Fieldbus adapter (FBA)</b>					
50.01	FBA A enable	List	0...1	-	1 = 1
50.02	FBA A comm loss func	List	0...5	-	1 = 1
50.03	FBA A comm loss t out	Real	0.3...6553.5	s	10 = 1 s
50.04	FBA A ref1 type	List	0...5	-	1 = 1
50.05	FBA A ref2 type	List	0...5	-	1 = 1
50.06	FBA A SW sel	List	0...1	-	1 = 1
50.07	FBA A actual 1 type	List	0...5	-	1 = 1
50.08	FBA A actual 2 type	List	0...5	-	1 = 1
50.09	FBA A SW transparent source	Analog src	-	-	1 = 1
50.10	FBA A act1 transparent source	Analog src	-	-	1 = 1
50.11	FBA A act2 transparent source	Analog src	-	-	1 = 1
50.12	FBA A debug mode	List	0...1	-	1 = 1
50.13	FBA A control word	Data	00000000h...FFFFFFFh	-	1 = 1
50.14	FBA A reference 1	Real	-2147483648... 2147483647	-	1 = 1
50.15	FBA A reference 2	Real	-2147483648... 2147483647	-	1 = 1
50.16	FBA A status word	Data	00000000h...FFFFFFFh	-	1 = 1
50.17	FBA A actual value 1	Real	-2147483648... 2147483647	-	1 = 1
50.18	FBA A actual value 2	Real	-2147483648... 2147483647	-	1 = 1
<b>51 FBA A settings</b>					
51.01	FBA A type	List	-	-	1 = 1
51.02	FBA A Par2	Real	0...65535	-	1 = 1
...	...	...	...	...	
51.26	FBA A Par26	Real	0...65535	-	1 = 1
51.27	FBA A par refresh	List	0...1	-	1 = 1
51.28	FBA A par table ver	Data	-	-	1 = 1
51.29	FBA A drive type code	Real	0...65535	-	1 = 1
51.30	FBA A mapping file ver	Real	0...65535	-	1 = 1
51.31	D2FBA A comm status	List	0...6	-	1 = 1
51.32	FBA A comm SW ver	Data	-	-	1 = 1
51.33	FBA A appl SW ver	Data	-	-	1 = 1
<b>52 FBA A data in</b>					
52.01	FBA A data in1	List	-	-	1 = 1
...	...	...	...	...	
52.12	FBA A data in12	List	-	-	1 = 1

## 472 Additional parameter data

No.	Name	Type	Range	Unit	FbEq32
<b>53 FBA A data out</b>					
53.01	FBA A data out1	<i>List</i>	-	-	1 = 1
...	...	...	...	...	
53.12	FBA A data out12	<i>List</i>	-	-	1 = 1
<b>58 Embedded fieldbus</b>					
58.01	Protocol enable	<i>List</i>	0...1	-	1 = 1
58.02	Protocol ID	<i>Real</i>	0000h...FFFFh	-	1 = 1
58.03	Node address	<i>Real</i>	0...255	-	1 = 1
58.04	Baud rate	<i>List</i>	0...7	-	1 = 1
58.05	Parity	<i>List</i>	0...3	-	1 = 1
58.06	Communication control	<i>List</i>	0...2	-	1 = 1
58.07	Communication diagnostics	<i>PB</i>	0000h...FFFFh	-	1 = 1
58.08	Received packets	<i>Real</i>	0...4294967295	-	1 = 1
58.09	Transmitted packets	<i>Real</i>	0...4294967295	-	1 = 1
58.10	All packets	<i>Real</i>	0...4294967295	-	1 = 1
58.11	UART errors	<i>Real</i>	0...4294967295	-	1 = 1
58.12	CRC errors	<i>Real</i>	0...4294967295	-	1 = 1
58.14	Communication loss action	<i>List</i>	0...5	-	1 = 1
58.15	Communication loss mode	<i>List</i>	1...2	-	1 = 1
58.16	Communication loss time	<i>Real</i>	0.0...6000.0	s	10 = 1 s
58.17	Transmit delay	<i>Real</i>	0...65535	ms	1 = 1 ms
58.18	EFB control word	<i>PB</i>	00000000h...FFFFFFFFh	-	1 = 1
58.19	EFB status word	<i>PB</i>	00000000h...FFFFFFFFh	-	1 = 1
58.25	Control profile	<i>List</i>	0, 5	-	1 = 1
58.26	EFB ref1 type	<i>List</i>	0...5	-	1 = 1
58.27	EFB ref2 type	<i>List</i>	0...5	-	1 = 1
58.28	EFB act1 type	<i>List</i>	0...5	-	1 = 1
58.29	EFB act2 type	<i>List</i>	0...5	-	1 = 1
58.31	EFB act1 transparent source	<i>Analog src</i>	-	-	1 = 1
58.32	EFB act2 transparent source	<i>Analog src</i>	-	-	1 = 1
58.33	Addressing mode	<i>List</i>	0...2	-	1 = 1
58.34	Word order	<i>List</i>	0...1	-	1 = 1
58.101	Data I/O 1	<i>Analog src</i>	-	-	1 = 1
58.102	Data I/O 2	<i>Analog src</i>	-	-	1 = 1
58.103	Data I/O 3	<i>Analog src</i>	-	-	1 = 1
58.104	Data I/O 4	<i>Analog src</i>	-	-	1 = 1



No.	Name	Type	Range	Unit	FbEq32
58.105	Data I/O 5	Analog src	-	-	1 = 1
58.106	Data I/O 6	Analog src	-	-	1 = 1
58.107	Data I/O 7	Analog src	-	-	1 = 1
...	...	...	...	...	
58.114	Data I/O 14	Analog src	-	-	1 = 1
<b>71 External PID1</b>					
71.01	External PID act value	Real	-200000.00...200000.00	%	100 = 1 PID customer unit
71.02	Feedback act value	Real	-200000.00...200000.00	PID customer units	100 = 1 PID customer unit
71.03	Setpoint act value	Real	-200000.00...200000.00	PID customer units	100 = 1 PID customer unit
71.04	Deviation act value	Real	-200000.00...200000.00	PID customer units	100 = 1 PID customer unit
71.06	PID status word	PB	0000h...FFFFh	-	1 = 1
71.07	PID operation mode	List	0...2	-	1 = 1
71.08	Feedback 1 source	Analog src	-	-	1 = 1
71.11	Feedback filter time	Real	0.000...30.000	s	1000 = 1 s
71.14	Setpoint scaling	Real	-200000.00...200000.00	-	100 = 1
71.15	Output scaling	Real	-200000.00...200000.00	-	100 = 1
71.16	Setpoint 1 source	Analog src	-	-	1 = 1
71.19	Internal setpoint sel1	Binary src	-	-	1 = 1
71.20	Internal setpoint sel2	Binary src	-	-	1 = 1
71.21	Internal setpoint 1	Real	-200000.00...200000.00	PID customer units	100 = 1 PID customer unit
71.22	Internal setpoint 2	Real	-200000.00...200000.00	PID customer units	100 = 1 PID customer unit
71.23	Internal setpoint 3	Real	-200000.00...200000.00	PID customer units	100 = 1 PID customer unit
71.26	Setpoint min	Real	-200000.00...200000.00	PID customer units	100 = 1 PID customer units
71.27	Setpoint max	Real	-200000.00...200000.00	PID customer units	100 = 1 PID customer units

## 474 Additional parameter data

No.	Name	Type	Range	Unit	FbEq32
71.31	Deviation inversion	<i>Binary src</i>	-	-	1 = 1
71.32	Gain	<i>Real</i>	0.101...100.00	-	100 = 1
71.33	Integration time	<i>Real</i>	0.0...9999.0	s	10 = 1 s
71.34	Derivation time	<i>Real</i>	0.000...10.000	s	1000 = 1 s
71.35	Derivation filter time	<i>Real</i>	0.0...10.0	s	1000 = 1 s
71.36	Output min	<i>Real</i>	-200000.00...200000.00	-	10 = 1
71.37	Output max	<i>Real</i>	-200000.00...200000.00	-	10 = 1
71.38	Output freeze enable	<i>Binary src</i>	-	-	1 = 1
71.39	Deadband range	<i>Real</i>	0.0...200000.0	PID customer units	10 = 1 PID customer unit
71.40	Deadband delay	<i>Real</i>	0.0...3600.0	s	1000 = 1 s
71.58	Increase prevention	<i>Binary src</i>	-	-	1 = 1
71.59	Decrease prevention	<i>Binary src</i>	-	-	1 = 1
71.62	Internal setpoint actual	<i>Real</i>	-200000.00...200000.00	PID customer units	100 = 1 PID customer unit
71.79	External PID units	<i>List</i>	-	-	1 = 1
<b>76 PFC configuration</b>					
76.01	PFC status	<i>PB</i>	0000h...FFFFh	-	1 = 1
76.02	Multipump system status	<i>List</i>	0...2, 100...103, 200...202, 300...302, 400, 500, 600, 800...801, 4...9	-	1 = 1
76.11	Pump/fan status 1	<i>PB</i>	0000h...FFFFh	-	1 = 1
76.12	Pump/fan status 2	<i>PB</i>	0000h...FFFFh	-	1 = 1
76.13	Pump/fan status 3	<i>PB</i>	0000h...FFFFh	-	1 = 1
76.14	Pump/fan status 4	<i>PB</i>	0000h...FFFFh	-	1 = 1
76.15	Pump/fan status 5	<i>PB</i>	0000h...FFFFh	-	1 = 1
76.16	Pump/fan status 6	<i>PB</i>	0000h...FFFFh	-	1 = 1
76.21	Multipump configuration	<i>List</i>	0, 2...3	-	1 = 1
76.25	Number of motors	<i>Real</i>	1...4	-	1 = 1
76.26	Min number of motors allowed	<i>Real</i>	0...4	-	1 = 1
76.27	Max number of motors allowed	<i>Real</i>	1...4	-	1 = 1
76.30	Start point 1	<i>Real</i>	0...32767	rpm/Hz	1 = 1 unit
76.31	Start point 2	<i>Real</i>	0...32767	rpm/Hz	1 = 1 unit
76.32	Start point 3	<i>Real</i>	0...32767	rpm/Hz	1 = 1 unit
76.33	Start point 4	<i>Real</i>	0...32767	rpm/Hz	1 = 1 unit
76.34	Start point 5	<i>Real</i>	0...32767	rpm/Hz	1 = 1 unit
76.41	Stop point 1	<i>Real</i>	0...32767	rpm/Hz	1 = 1 unit
76.42	Stop point 2	<i>Real</i>	0...32767	rpm/Hz	1 = 1 unit

No.	Name	Type	Range	Unit	FbEq32
76.43	Stop point 3	<i>Real</i>	0...32767	rpm/Hz	1 = 1 unit
76.44	Stop point 4	<i>Real</i>	0...32767	rpm/Hz	1 = 1 unit
76.45	Stop point 5	<i>Real</i>	0...32767	rpm/Hz	1 = 1 unit
76.55	Start delay	<i>Real</i>	0.00...12600.00	s	100 = 1 s
76.56	Stop delay	<i>Real</i>	0.00...12600.00	s	100 = 1 s
76.57	PFC speed hold on	<i>Real</i>	0.00...1000.00	s	100 = 1 s
76.58	PFC speed hold off	<i>Real</i>	0.00...1000.00	s	100 = 1 s
76.59	PFC contactor delay	<i>Real</i>	0.20...600.00	s	100 = 1 s
76.60	PFC ramp acceleration time	<i>Real</i>	0.00...1800.00	s	100 = 1 s
76.61	PFC ramp deceleration time	<i>Real</i>	0.00...1800.00	s	100 = 1 s
76.70	PFC autochange	<i>Binary src</i>	-	-	1 = 1
76.71	PFC autochange interval	<i>Real</i>	0.00...42949672.95	h	100 = 1 h
76.72	Maximum wear imbalance	<i>Real</i>	0.00...1000000.00	h	100 = 1 h
76.73	Autochange level	<i>Real</i>	0.0...300.0	%	10 = 1 %
76.74	Autochange auxiliary PFC	<i>List</i>	0...1	-	1 = 1
76.81	PFC 1 interlock	<i>Binary src</i>	-	-	1 = 1
76.82	PFC 2 interlock	<i>Binary src</i>	-	-	1 = 1
76.83	PFC 3 interlock	<i>Binary src</i>	-	-	1 = 1
76.84	PFC 4 interlock	<i>Binary src</i>	-	-	1 = 1
76.85	PFC 5 interlock	<i>Binary src</i>	-	-	1 = 1
76.86	PFC 6 interlock	<i>Binary src</i>	-	-	1 = 1
76.95	Regulator bypass control	<i>Binary src</i>	-	-	1 = 1
<b>77 PFC maintenance and monitoring</b>					
77.10	PFC runtime change	<i>List</i>	0...7	-	1 = 1
77.11	Pump/fan 1 running time	<i>Real</i>	0.00...42949672.95	h	100 = 1 h
77.12	Pump/fan 2 running time	<i>Real</i>	0.00...42949672.95	h	100 = 1 h
77.13	Pump/fan 3 running time	<i>Real</i>	0.00...42949672.95	h	100 = 1 h
77.14	Pump/fan 4 running time	<i>Real</i>	0.00...42949672.95	h	100 = 1 h
77.15	Pump/fan 5 running time	<i>Real</i>	0.00...42949672.95	h	100 = 1 h
77.16	Pump/fan 6 running time	<i>Real</i>	0.00...42949672.95	h	100 = 1 h
<b>95 HW configuration</b>					
95.01	Supply voltage	<i>List</i>	0...3, 5	-	1 = 1
95.02	Adaptive voltage limits	<i>List</i>	0...1	-	1 = 1
95.03	Estimated AC supply voltage	<i>Real</i>	0...65535	V	1 = 1 V
95.04	Control board supply	<i>List</i>	0...1	-	1 = 1
95.15	Special HW settings	<i>PB</i>	0000000h...FFFFFFFh	-	1 = 1

## 476 Additional parameter data

No.	Name	Type	Range	Unit	FbEq32
95.20	HW options word 1	<i>PB</i>	0000h...FFFFh	-	1 = 1
95.21	HW options word 2	<i>PB</i>	0000h...FFFFh	-	1 = 1
95.26	Motor disconnect detection	<i>List</i>	0...1	-	1 = 1
95.200	Cooling fan mode	<i>List</i>	0...1	-	1 = 1
<b>96 System</b>					
96.01	Language	<i>List</i>	-	-	1 = 1
96.02	Pass code	<i>Data</i>	0...99999999	-	1 = 1
96.03	Access level status	<i>PB</i>	00000000h...FFFFFFFFh	-	1 = 1
96.04	Macro select	<i>List</i>	0...3, 11...17	-	1 = 1
96.05	Macro active	<i>List</i>	1...3, 11...17	-	1 = 1
96.06	Parameter restore	<i>List</i>	0, 2, 8, 32, 62, 512, 1024, 34560	-	1 = 1
96.07	Parameter save manually	<i>List</i>	0...1	-	1 = 1
96.08	Control board boot	<i>List</i>	0...1	-	1 = 1
96.10	User set status	<i>List</i>	0...7, 20...23	-	1 = 1
96.11	User set save/load	<i>List</i>	0...5, 18...21	-	1 = 1
96.12	User set I/O mode in1	<i>Binary src</i>	-	-	-
96.13	User set I/O mode in2	<i>Binary src</i>	-	-	-
96.16	Unit selection	<i>PB</i>	000h...FFFFh	-	1 = 1
96.20	Time sync primary source	<i>List</i>	0, 2, 6, 8, 9	-	1 = 1
96.51	Clear fault and event logger	<i>Real</i>	0...1	-	1 = 1
96.54	Checksum action	<i>Binary src</i>	-	-	1 = 1
96.55	Checksum control word	<i>Binary src</i>	-	-	-
96.68	Actual checksumA	<i>Binary src</i>	-	-	1 = 1
96.69	Actual checksumB	<i>Binary src</i>	-	-	1 = 1
96.70	Disable adaptive program	<i>List</i>	0...1	-	1 = 1
96.71	Approved checksum A	<i>Binary src</i>	-	-	1 = 1
96.72	Approved checksum B	<i>Binary src</i>	-	-	1 = 1
96.78	550 compatibility mode	<i>List</i>	0...1	-	1 = 1
96.100	Change user pass code	<i>Data</i>	10000000...99999999	-	1 = 1
96.101	Confirm user pass code	<i>Data</i>	10000000...99999999	-	1 = 1
96.102	User lock functionality	<i>PB</i>	0000h...FFFFh	-	1 = 1
<b>97 Motor control</b>					
97.01	Switching frequency reference	<i>List</i>	2, 4, 8, 12	kHz	1 = 1 kHz
97.02	Minimum switching frequency	<i>List</i>	1.5, 2, 4, 8, 12	kHz	1 = 1 kHz
97.03	Slip gain	<i>Real</i>	0...200	%	1 = 1%

No.	Name	Type	Range	Unit	FbEq32
97.04	Voltage reserve	<i>Real</i>	-4...50	%	1 = 1%
97.05	Flux braking	<i>List</i>	0...2	-	1 = 1
97.08	Optimizer minimum torque	<i>Real</i>	0.0 ... 1600.0	%	10 = 1%
97.10	Signal injection	<i>List</i>	0...4	-	1 = 1
97.11	TR tuning	<i>Real</i>	25...400	%	1 = 1%
97.13	IR compensation	<i>Real</i>	0.00...50.00	%	100 = 1%
97.15	Motor model temperature adaptation	<i>List</i>	0...1	-	1 = 1
97.16	Stator temperature factor	<i>Real</i>	0...200	%	1 = 1%
97.17	Rotor temperature factor	<i>Real</i>	0...200	%	1 = 1%
97.20	U/F ratio	<i>List</i>	0...1	-	1 = 1
97.48	Udc stabilizer	<i>List</i>	0, 50, 100, 300, 500, 800	-	1 = 1
97.49	Slip gain for scalar	<i>Real</i>	0...3	%	1 = 1%
97.94	IR comp max frequency	<i>Real</i>	1.0...200.0	%	10 = 1%
97.135	Udc ripple	<i>Real</i>	0.0...200.0	V	10 = 1V
<b>98 User motor parameters</b>					
98.01	User motor model mode	<i>List</i>	0...1	-	1 = 1
98.02	Rs user	<i>Real</i>	0.0000...0.50000	p.u.	100000 = 1 p.u.
98.03	Rr user	<i>Real</i>	0.0000...0.50000	p.u.	100000 = 1 p.u.
98.04	Lm user	<i>Real</i>	0.00000...10.00000	p.u.	100000 = 1 p.u.
98.05	SigmaL user	<i>Real</i>	0.00000...1.00000	p.u.	100000 = 1 p.u.
98.06	Ld user	<i>Real</i>	0.00000...10.00000	p.u.	100000 = 1 p.u.
98.07	Lq user	<i>Real</i>	0.00000...10.00000	p.u.	100000 = 1 p.u.
98.08	PM flux user	<i>Real</i>	0.00000...2.00000	p.u.	100000 = 1 p.u.
98.09	Rs user SI	<i>Real</i>	0.00000...100.00000	ohm	100000 = 1 p.u.
98.10	Rr user SI	<i>Real</i>	0.00000...100.00000	ohm	100000 = 1 p.u.
98.11	Lm user SI	<i>Real</i>	0.00...100000.00	mH	100 = 1 mH
98.12	SigmaL user SI	<i>Real</i>	0.00...100000.00	mH	100 = 1 mH
98.13	Ld user SI	<i>Real</i>	0.00...100000.00	mH	100 = 1 mH
98.14	Lq user SI	<i>Real</i>	0.00...100000.00	mH	100 = 1 mH
<b>99 Motor data</b>					
99.03	Motor type	<i>List</i>	0...2	-	1 = 1
99.04	Motor control mode	<i>List</i>	0...1	-	1 = 1
99.06	Motor nominal current	<i>Real</i>	0.0...6400.0	A	10 = 1 A
99.07	Motor nominal voltage	<i>Real</i>	0.0...960.0	V	10 = 1 V

478 *Additional parameter data*

No.	Name	Type	Range	Unit	FbEq32
99.08	Motor nominal frequency	<i>Real</i>	0.0 ... 500.0	Hz	100 = 1 Hz
99.09	Motor nominal speed	<i>Real</i>	0 ... 30000	rpm	1 = 1 rpm
99.10	Motor nominal power	<i>Real</i>	0.00...10000.00 kW or 0.00 ... 13404.83 hp	kW or hp	100 = 1 unit
99.11	Motor nominal cos $\Phi$	<i>Real</i>	0.00 ... 1.00	-	100 = 1
99.12	Motor nominal torque	<i>Real</i>	0.000...400000.000 N·m or 0.000...2950248.597 lb·ft	N·m or lb·ft	1000 = 1 unit
99.13	ID run requested	<i>List</i>	0...3, 5...6	-	1 = 1
99.14	Last ID run performed	<i>List</i>	0...3, 5...6	-	1 = 1
99.15	Motor polepairs calculated	<i>Real</i>	0...1000	-	1 = 1
99.16	Motor phase order	<i>List</i>	0...1	-	1 = 1

## 9

# Fault tracing

---

## What this chapter contains

The chapter lists the warning and fault messages including possible causes and corrective actions. The causes of most warnings and faults can be identified and corrected using the information in this chapter. If not, contact an ABB service representative. If you have a possibility to use the Drive composer PC tool, send the Support package created by the Drive composer to the ABB service representative.

Warnings and faults are listed below in separate tables. Each table is sorted by warning/fault code.

## Safety



**WARNING!** Only qualified electricians are allowed to service the drive. Read the instructions in chapter *Safety instructions* at the beginning of the *Hardware manual* of the drive before working on the drive.

---

## Indications

### ■ Warnings and faults

Warnings and faults indicate an abnormal drive status. The codes and names of active warnings and faults are displayed on the control panel of the drive as well as in the Drive composer PC tool. Only the codes of warnings and faults are available over fieldbus.

Warnings do not need to be reset; they stop showing when the cause of the warning ceases. Warnings do not trip the drive and it will continue to operate the motor.

---

Faults latch inside the drive and cause the drive to trip, and the motor stops. After the cause of a fault has been removed, the fault can be reset from a selectable source (**Menu - Primary settings - Advanced functions - Reset faults manually (Reset faults manually from:)**) on the control panel; or parameter [31.11 Fault reset selection](#)) such as the control panel, Drive composer PC tool, the digital inputs of the drive, or fieldbus. Resetting the fault creates an event [64FF Fault reset](#). After the reset, the drive can be restarted.

Note that some faults require a reboot of the control unit either by switching the power off and on, or using parameter [96.08 Control board boot](#) – this is mentioned in the fault listing wherever appropriate.

### ■ Pure events

In addition to warnings and faults, there are pure events that are only recorded in the event log of the drive. The codes of these events are included in the [Warning messages](#) table on page [\(482\)](#).

### ■ Editable messages

For external events, the action (fault or warning), name and the message text can be edited. To specify external events, select **Menu - Primary settings - Advanced functions - External events**.

Contact information can also be included and the text edited. To specify contact information, select **Menu - Primary settings - Clock, region, display - Contact info view**.

## Warning/fault history

### ■ Event log

All indications are stored in the event log with a time stamp and other information. The event log stores information on

- the last 8 fault recordings, that is, faults that tripped the drive or fault resets
- the last 10 warnings or pure events that occurred.

See section [Viewing warning/fault information](#) on page [481](#).

### Auxiliary codes

Some events generate an auxiliary code that often helps in pinpointing the problem. On the control panel, the auxiliary code is stored as part of the details of the event; in the Drive composer PC tool, the auxiliary code is shown in the event listing.

---



## ■ Viewing warning/fault information

The drive is able to store a list of the active faults actually causing the drive to trip at the present time. The drive also stores a list of faults and warnings that have previously occurred.

For each stored fault, the control panel shows the fault code, time and values of nine parameters (actual signals and status words) stored at the time of the fault. The values for the latest fault are in parameters [05.80](#)...[05.88](#).

For active faults and warnings, see

- **Menu - Diagnostics - Active faults**
- **Menu - Diagnostics - Active warnings**
- **Options - Active faults**
- **Options - Active warnings**
- parameters in group [04 Warnings and faults](#) (page [203](#)).

For previously occurred faults and warnings, see

- **Menu - Diagnostics - Fault & event log**
- parameters in group [04 Warnings and faults](#) (page [203](#)).

The event log can also be accessed (and reset) using the Drive composer PC tool. See *Drive composer PC tool user's manual* (3AUA0000094606 [English]).

## QR code generation for mobile service application

A QR code (or a series of QR codes) can be generated by the drive for display on the control panel. The QR code contains drive identification data, information on the latest events, and values of status and counter parameters. The code can be read with a mobile device containing the ABB service application, which then sends the data to ABB for analysis. For more information on the application, contact your local ABB service representative.

To generate the QR code, select **Menu - System info - QR code**.

**Note:** If a control panel which does not support QR code generation (version older than v.6.4x) is used, the **QR code** menu entry will disappear totally and will not be available any longer either with control panels supporting the QR code generation.

## Warning messages

**Note:** The list also contains events that only appear in the Event log.

Code (hex)	Warning / Aux. code	Cause	What to do
64FF	Fault reset	A fault has been reset from the control panel, Drive composer PC tool, fieldbus or I/O.	Event. Informative only.
B686	Checksum mismatch	Parameter checksum <a href="#">96.68 Actual checksumA</a> does not match <a href="#">96.71 Approved checksum A</a> and/ or parameter checksum <a href="#">96.69 Actual checksumB</a> does not match <a href="#">96.72 Approved checksum B</a> .	Event. Informative only.
A2A1	Current calibration	Current offset and gain measurement calibration will occur at next start.	Informative warning. (See parameter <a href="#">99.13 ID run requested</a> .)
A2B1	Overcurrent	Output current has exceeded internal fault limit. In addition to an actual overcurrent situation, this warning may also be caused by an earth fault or supply phase loss.	<p>Check motor load.</p> <p>Check acceleration times in parameter group <a href="#">23 Speed reference ramp</a> (speed control), <a href="#">26 Torque reference chain</a> (torque control) or <a href="#">28 Frequency reference chain</a> (frequency control). Also check parameters <a href="#">46.01 Speed scaling</a>, <a href="#">46.02 Frequency scaling</a> and <a href="#">46.03 Torque scaling</a>.</p> <p>Check motor and motor cable (including phasing and delta/star connection).</p> <p>Check for an earth fault in motor or motor cables by measuring the insulation resistances of motor and motor cable. See chapter <i>Electrical installation</i>, section <i>Checking the insulation of the assembly</i> in the <i>Hardware manual</i> of the drive.</p> <p>Check there are no contactors opening and closing in motor cable.</p> <p>Check that the start-up data in parameter group <a href="#">99 Motor data</a> corresponds to the motor rating plate.</p> <p>Check that there are no power factor correction capacitors or surge absorbers in motor cable.</p>
A2B3	Earth leakage	Drive has detected load unbalance typically due to earth fault in motor or motor cable.	<p>Check there are no power factor correction capacitors or surge absorbers in motor cable.</p> <p>Check for an earth fault in motor or motor cables by measuring the insulation resistances of motor and motor cable. See chapter <i>Electrical installation</i>, section <i>Checking the insulation of the assembly</i> in the <i>Hardware manual</i> of the drive. If an earth fault is found, fix or change the motor cable and/or motor. If no earth fault can be detected, contact your local ABB representative.</p>

Code (hex)	Warning / Aux. code	Cause	What to do
A2B4	Short circuit	Short-circuit in motor cable(s) or motor.	<p>Check motor and motor cable for cabling errors.</p> <p>Check motor and motor cable (including phasing and delta/star connection). Check for an earth fault in motor or motor cables by measuring the insulation resistances of motor and motor cable. See chapter <i>Electrical installation</i>, section <i>Checking the insulation of the assembly</i> in the <i>Hardware manual</i> of the drive.</p> <p>Check there are no power factor correction capacitors or surge absorbers in motor cable.</p>
A2BA	IGBT overload	Excessive IGBT junction to case temperature. This warning protects the IGBT(s) and can be activated by a short circuit in the motor cable.	<p>Check motor cable.</p> <p>Check ambient conditions.</p> <p>Check air flow and fan operation.</p> <p>Check heatsink fins for dust pick-up.</p> <p>Check motor power against drive power.</p>
A3A1	DC link overvoltage	Intermediate circuit DC voltage too high (when the drive is stopped).	<p>Check the supply voltage setting (parameter <a href="#">95.01 Supply voltage</a>). Note that the wrong setting of the parameter may cause the motor to rush uncontrollably, or may overload the brake chopper or resistor.</p> <p>Check the supply voltage.</p> <p>If the problem persists, contact your local ABB representative.</p>
A3A2	DC link undervoltage	Intermediate circuit DC voltage too low (when the drive is stopped).	
A3AA	DC not charged	The voltage of the intermediate DC circuit has not yet risen to operating level.	
A490	Incorrect temperature sensor setup	Temperature cannot be supervised due to incorrect adapter setup. AO settings do not match with <a href="#">35.11</a> and <a href="#">35.21</a> .	<p>Check the settings of temperature source parameters <a href="#">35.11</a> and <a href="#">35.21</a>.</p> <p>Check the settings of temperature source parameters <a href="#">35.11</a> and <a href="#">35.21</a> against AO parameters <a href="#">13.12</a> and <a href="#">13.22</a>.</p>
A491	External temperature 1 (Editable message text)	Measured temperature 1 has exceeded warning limit.	<p>Check the value of parameter <a href="#">35.02 Measured temperature 1</a>.</p> <p>Check the cooling of the motor (or other equipment whose temperature is being measured).</p> <p>Check the value of <a href="#">35.13 Temperature 1 warning limit</a>.</p>
A492	External temperature 2 (Editable message text)	Measured temperature 2 has exceeded warning limit.	<p>Check the value of parameter <a href="#">35.03 Measured temperature 2</a>.</p> <p>Check the cooling of the motor (or other equipment whose temperature is being measured).</p> <p>Check the value of <a href="#">35.23 Temperature 2 warning limit</a>.</p>
A4A0	Control board temperature	Control unit temperature is too high.	Check the auxiliary code. See actions for each code below.
	(none)	Temperature above warning limit	<p>Check ambient conditions.</p> <p>Check air flow and fan operation.</p> <p>Check heatsink fins for dust pick-up.</p>
	1	Thermistor broken	Contact an ABB service representative for control unit replacement.

Code (hex)	Warning / Aux. code	Cause	What to do
A4A1	IGBT overtemperature	Estimated drive IGBT temperature is excessive.	Check ambient conditions. Check air flow and fan operation. Check heatsink fins for dust pick-up. Check motor power against drive power.
A4A9	Cooling	Drive module temperature is excessive.	Check ambient temperature. If it exceeds 40 °C/104 °F (IP21 frames R4...R9) or if it exceeds 50 °C /122 °F (IP21 frames R1...R9), ensure that load current does not exceed derated load capacity of drive. For all P55 frames, check the derating temperatures. See chapter <i>Technical data</i> , section <i>Derating</i> in the <i>Hardware manual</i> of the drive. Check drive module cooling air flow and fan operation. Check inside of cabinet and heatsink of drive module for dust pick-up. Clean whenever necessary.
A4B0	Excess temperature	Power unit module temperature is excessive.	Check ambient conditions. Check air flow and fan operation. Check heatsink fins for dust pick-up. Check motor power against drive power. (1: U-phase, 2: V-phase, 3: W-phase, 4: INT board, 6: Air inlet (sensor connected to INT board X10), 7: PCB compartment fan or power supply board, FA: Ambient temperature).
A4B1	Excess temperature difference	High temperature difference between the IGBTs of different phases.	Check the motor cabling. Check cooling of drive module(s).
A4F6	IGBT temperature	Drive IGBT temperature is excessive.	Check ambient conditions. Check air flow and fan operation. Check heatsink fins for dust pick-up. Check motor power against drive power.
A581	Fan	Cooling fan feedback missing. For frame sizes R6 or larger	Check the auxiliary code to identify the fan. Code <b>0</b> denotes main fan 1. Other codes (format XYZ): "X" specifies state code (1: ID run, 2: normal). "Y" = 0, "Z" specifies the index of the fan (1: Main fan 1, 2: Main fan 2, 3: Main fan 3). Check fan operation and connection. Replace fan if faulty.
A582	Auxiliary fan missing	An auxiliary cooling fan (IP55 internal fan) is stuck or disconnected.	Check the auxiliary code. Check the auxiliary fan and connection. Replace faulty fan. Make sure the front cover of the drive is in place and tightened. If the commissioning of the drive requires that the cover is off, this warning will be generated even if the corresponding fault is defeated. See fault <a href="#">5081 Auxiliary fan broken</a> (page 496).

Code (hex)	Warning / Aux. code	Cause	What to do
A5A0	Safe torque off Programmable warning: <i>31.22 STO indication run/stop</i>	Safe torque off function is active, that is, safety circuit signal(s) connected to connector STO is lost.	Check safety circuit connections. For more information, chapter <i>The Safe torque off function</i> in the <i>Hardware manual</i> of the drive and description of parameter <i>31.22 STO indication run/stop</i> (page 313). Check the value of parameter <i>95.04 Control board supply</i> .
A5EA	Measurement circuit temperature	Problem with internal temperature measurement of the drive. Aux code depends on control unit type.	Contact your local ABB representative.
		Frames R1...R5	
	0000 0001	IGBT temperature	
	0000 0003	Board temperature	
	0000 0006	Power supply temperature	
		Frames R6...R11	
	0000 0001	U-phase IGBT	
	0000 0002	V-phase IGBT	
	0000 0003	W-phase IGBT	
	0000 0004	Board temperature	
	0000 0005	Brake chopper	
	0000 0006	Air inlet (TEMP3)	
	0000 0007	Power supply temperature	
	0000 0008	du/dt (TEMP2)	
	0000 0009	TEMP1	
	FAh =1111 1010	Ambient temperature	
A5EB	PU board powerfail	Power unit power supply failure.	Contact your local ABB representative.
A5ED	Measurement circuit ADC	Measurement circuit fault.	Contact your local ABB representative.
A5EE	Measurement circuit DFF	Measurement circuit fault.	Contact your local ABB representative.
A5EF	PU state feedback	State feedback from output phases does not match control signals.	Contact your local ABB representative.
A5F0	Charging feedback	Charging feedback signal missing.	Check the feedback signal coming from the charging system.
A682	Flash erase speed exceeded	The flash memory (in the memory unit) has been erased too frequently, compromising the lifetime of the memory.	Avoid forcing unnecessary parameter saves by parameter <i>96.07</i> or cyclic parameter writes (such as user logger triggering through parameters). Check the auxiliary code (format XYYY YZZZ). "X" specifies the source of warning (1: generic flash erase supervision). "ZZZ" specifies the flash subsector number that generated the warning.

Code (hex)	Warning / Aux. code	Cause	What to do
A686	Checksum mismatch	Parameter checksum <a href="#">96.68 Actual checksumA</a> does not match <a href="#">96.71 Approved checksum A</a> and/ or parameter checksum <a href="#">96.69 Actual checksumB</a> does not match <a href="#">96.72 Approved checksum B</a> .	Revert parameter changes made after approving the checksum. If parameter changes are valid, approve new checksum by setting parameter <a href="#">96.55 Checksum control word</a> bit 12 ( <a href="#">Set approved checksum A</a> ) and/or 13 ( <a href="#">Set approved checksum B</a> ) to 1 = Set.
A6A4	Motor nominal value	The motor parameters are set incorrectly. The drive is not dimensioned correctly.	Check the auxiliary code. See actions for each code below.  Check the settings of the motor configuration parameters in groups 98 and 99. Check that the drive is sized correctly for the motor.
	0001	Slip frequency is too small.	
	0002	Synchronous and nominal speeds differ too much.	
	0003	Nominal speed is higher than synchronous speed with 1 pole pair.	
	0004	Nominal current is outside limits	
	0005	Nominal voltage is outside limits.	
	0006	Nominal power is higher than apparent power.	
	0007	Nominal power not consistent with nominal speed and torque.	
A6A5	No motor data	Parameters in group 99 have not been set.	Check that all the required parameters in group 99 have been set. <b>Note:</b> It is normal for this warning to appear during the start-up and continue until the motor data is entered.
A6A6	Voltage category unselected	The voltage category has not been defined.	Set voltage category in parameter <a href="#">95.01 Supply voltage</a> .
A6A7	System time not set	System time is not set. Timed functions cannot be used and fault log dates are not correct.	Set the system time manually or connect the control panel to the drive to synchronize the clock. If basic control panel is used, synchronize the clock through the EFB or a fieldbus module. Set parameter <a href="#">34.10 Timed functions enable</a> to <a href="#">Disabled</a> to disable the timed functions if they are not used.
A6B0	User lock is open	The user lock is open, ie. user lock configuration parameters <a href="#">96.100...96.102</a> are visible.	Close the user lock by entering an invalid pass code in parameter <a href="#">96.02 Pass code</a> . See section <a href="#">User lock</a> (page <a href="#">192</a> ).
A6B1	User pass code not confirmed	A new user pass code has been entered in parameter <a href="#">96.100</a> but not confirmed in <a href="#">96.101</a> .	Confirm the new pass code by entering the same code in <a href="#">96.101</a> . To cancel, close the user lock without confirming the new code. See section <a href="#">User lock</a> (page <a href="#">192</a> ).

Code (hex)	Warning / Aux. code	Cause	What to do
A6D1	FBA A parameter conflict	The drive does not have a functionality requested by a PLC, or requested functionality has not been activated.	Check PLC programming. Check settings of parameter groups <a href="#">50 Fieldbus adapter (FBA)</a> .
A6E5	AI parametrization	The current/voltage hardware setting of an analog input does not correspond to parameter settings.	Check the event log for an auxiliary code. The code identifies the analog input whose settings are in conflict. Adjust either the hardware setting (on the drive control unit) or parameter <a href="#">12.15/12.25</a> . <b>Note:</b> Control unit reboot (either by cycling the power or through parameter <a href="#">96.08 Control board boot</a> ) is required to validate any changes in the hardware settings.
A6E6	ULC configuration	User load curve configuration error.	Check the auxiliary code (format XXXX ZZZZ). "ZZZZ" indicates the problem (see actions for each code below).
	0000	Speed points inconsistent.	Check that each speed point (parameters <a href="#">37.11...37.15</a> ) has a higher value than the previous point.
	0001	Frequency points inconsistent.	Check that each frequency point ( <a href="#">37.20...37.16</a> ) has a higher value than the previous point.
	0002	Underload point above overload point.	Check that each overload point ( <a href="#">37.31...37.35</a> ) has a higher value than the corresponding underload point ( <a href="#">37.21...37.25</a> ).
	0003	Overload point below underload point.	
A780	Motor stall Programmable warning: <a href="#">31.24 Stall function</a>	Motor is operating in stall region because of, for example, excessive load or insufficient motor power.	Check motor load and drive ratings. Check fault function parameters.
A783	Motor overload	Motor current is too high.	Check for overloaded motor. Adjust the parameters used for the motor overload function ( <a href="#">35.51...35.53</a> ) and <a href="#">35.55...35.56</a> .
A784	Motor disconnect	All three output phases are disconnected from motor.	Check that switches between drive and motor are closed. Check that all cables between drive and motor are connected and secured. If no issue was detected and drive output was actually connected to motor, contact ABB.
A792	Brake resistor wiring	Brake resistor short circuit or brake chopper control fault. For frame sizes R6 or larger.	Check brake chopper and brake resistor connection. Ensure brake resistor is not damaged.

Code (hex)	Warning / Aux. code	Cause	What to do
A793	BR excess temperature	Brake resistor temperature has exceeded warning limit defined by parameter <a href="#">43.12 Brake resistor warning limit</a> .	Stop drive. Let resistor cool down. Check resistor overload protection function settings (parameter group <a href="#">43 Brake chopper</a> ). Check warning limit setting, parameter <a href="#">43.12 Brake resistor warning limit</a> . Check that the resistor has been dimensioned correctly. Check that braking cycle meets allowed limits.
A794	BR data	Brake resistor data has not been given.	One or more of the resistor data settings (parameters <a href="#">43.08...43.10</a> ) is incorrect. The parameter is specified by the auxiliary code.
	0000 0001	Resistance value too low.	Check value of <a href="#">43.10</a> .
	0000 0002	Thermal time constant not given.	Check value of <a href="#">43.08</a> .
	0000 0003	Maximum continuous power not given.	Check value of <a href="#">43.09</a> .
A79C	BC IGBT excess temperature	Brake chopper IGBT temperature has exceeded internal warning limit.	Let chopper cool down. Check for excessive ambient temperature. Check for cooling fan failure. Check for obstructions in the air flow. Check the dimensioning and cooling of the cabinet. Check resistor overload protection function settings (parameters <a href="#">43.06...43.10</a> ). Check minimum allowed resistor value for the chopper being used. Check that braking cycle meets allowed limits. Check that drive supply AC voltage is not excessive.
A7A2	Mechanical brake opening failed	Status of mechanical brake acknowledgement is not as expected during brake open.	Check mechanical brake connection. Check mechanical brake settings in parameter group <a href="#">44 Mechanical brake control</a> . Check that acknowledgement signal matches the actual status of brake.
A7AB	Extension I/O configuration failure	Installed C-type module is not the same as configured or the communication between the drive and module has been disturbed.	Check that the installed module (shown by parameter <a href="#">15.02 Detected extension module</a> ) is the same as selected by parameter <a href="#">15.01 Extension module type</a> . Eliminate the disturbance sources.



Code (hex)	Warning / Aux. code	Cause	What to do
A7C1	FBA A communication Programmable warning: <a href="#">50.02 FBA A comm loss func</a>	Cyclical communication between drive and fieldbus adapter module A or between PLC and fieldbus adapter module A is lost.	Check status of fieldbus communication. See user documentation of fieldbus interface.  Check settings of parameter groups <a href="#">50 Fieldbus adapter (FBA)</a> , <a href="#">51 FBA A settings</a> , <a href="#">52 FBA A data in</a> and <a href="#">53 FBA A data out</a> .  Check cable connections.  Check if communication master is able to communicate.
A7CE	EFB comm loss Programmable warning: <a href="#">58.14 Communication loss action</a>	Communication break in embedded fieldbus (EFB) communication.	Check the status of the fieldbus master (online/offline/error etc.).  Check cable connections to the EIA-485/X5 terminals 29, 30 and 31 on the control unit.
A7EE	Panel loss Programmable warning: <a href="#">49.05 Communication loss action</a>	Control panel or PC tool selected as active control location for drive has ceased communicating.	Check PC tool or control panel connection.  Check control panel connector.  Check mounting platform if being used.  Disconnect and reconnect the control panel.
A88F	Cooling fan	Maintenance timer limit exceeded.	Consider changing the cooling fan. Parameter <a href="#">05.04 Fan on-time counter</a> shows the running time of the cooling fan.
A8A0	AI supervision Programmable warning: <a href="#">12.03 AI supervision function</a>	An analog signal is outside the limits specified for the analog input.	Check signal level at the analog input.  Check the wiring connected to the input.  Check the minimum and maximum limits of the input in parameter group <a href="#">12 Standard AI</a> .
A8A1	RO life warning	The relay has changed states more than the recommended number of times.	Change the control unit or stop using the relay output.
	0001	Relay output 1	Change the control unit or stop using relay output 1.
	0002	Relay output 2	Change the control unit or stop using relay output 2.
	0003	Relay output 3	Change the control unit or stop using relay output 3.
A8A2	RO toggle warning	The relay output is changing states faster than recommended, for example, if a fast changing frequency signal is connected to it. The relay lifetime will be exceeded shortly.	Replace the signal connected to the relay output source with a less frequently changing signal.
	0001	Relay output 1	Select a different signal with parameter <a href="#">10.24 RO1 source</a> .
	0002	Relay output 2	Select a different signal with parameter <a href="#">10.27 RO2 source</a> .
	0003	Relay output 3	Select a different signal with parameter <a href="#">10.30 RO3 source</a> .

<b>Code (hex)</b>	<b>Warning / Aux. code</b>	<b>Cause</b>	<b>What to do</b>
A8B0	ABB Signal supervision 1 (Editable message text) Programmable warning: <a href="#">32.06 Supervision 1 action</a>	Warning generated by the signal supervision function 1.	Check the source of the warning (parameter <a href="#">32.07 Supervision 1 signal</a> ).
A8B1	ABB Signal supervision 2 (Editable message text) Programmable warning: <a href="#">32.16 Supervision 2 action</a>	Warning generated by the signal supervision function 2.	Check the source of the warning (parameter <a href="#">32.17 Supervision 2 signal</a> ).
A8B2	ABB Signal supervision 3 (Editable message text) Programmable warning: <a href="#">32.26 Supervision 3 action</a>	Warning generated by the signal supervision function 3.	Check the source of the warning (parameter <a href="#">32.27 Supervision 3 signal</a> ).
A8B3	ABB Signal supervision 4 (Editable message text) Programmable warning: <a href="#">32.36 Supervision 4 action</a>	Warning generated by the signal supervision function 4.	Check the source of the warning (parameter <a href="#">32.37 Supervision 4 signal</a> ).
A8B4	ABB Signal supervision 5 (Editable message text) Programmable warning: <a href="#">32.46 Supervision 5 action</a>	Warning generated by the signal supervision function 5.	Check the source of the warning (parameter <a href="#">32.47 Supervision 5 signal</a> ).
A8B5	ABB Signal supervision 6 (Editable message text) Programmable warning: <a href="#">32.56 Supervision 6 action</a>	Warning generated by the signal supervision function 6.	Check the source of the warning (parameter <a href="#">32.57 Supervision 6 signal</a> ).
A8BE	ULC overload warning Programmable fault: <a href="#">37.03 ULC overload actions</a>	Selected signal has exceeded the user overload curve.	Check for any operating conditions increasing the monitored signal (for example, the loading of the motor if the torque or current is being monitored). Check the definition of the load curve (parameter group <a href="#">37 User load curve</a> ).
A8BF	ULC underload warning Programmable fault: <a href="#">37.04 ULC underload actions</a>	Selected signal has fallen below the user underload curve.	Check for any operating conditions decreasing the monitored signal (for example, loss of load if the torque or current is being monitored). Check the definition of the load curve (parameter group <a href="#">37 User load curve</a> ).
A981	External warning 1 (Editable message text) Programmable warning: <a href="#">31.01 External event 1 source</a> <a href="#">31.02 External event 1 type</a>	Fault in external device 1.	Check the external device. Check setting of parameter <a href="#">31.01 External event 1 source</a> .
A982	External warning 2 (Editable message text) Programmable warning: <a href="#">31.03 External event 2 source</a> <a href="#">31.04 External event 2 type</a>	Fault in external device 2.	Check the external device. Check setting of parameter <a href="#">31.03 External event 2 source</a> .

Code (hex)	Warning / Aux. code	Cause	What to do
A983	External warning 3 (Editable message text) Programmable warning: <a href="#">31.05 External event 3 source</a> <a href="#">31.06 External event 3 type</a>	Fault in external device 3.	Check the external device. Check setting of parameter <a href="#">31.05 External event 3 source</a> .
A984	External warning 4 (Editable message text) Programmable warning: <a href="#">31.07 External event 4 source</a> <a href="#">31.08 External event 4 type</a>	Fault in external device 4.	Check the external device. Check setting of parameter <a href="#">31.07 External event 4 source</a> .
A985	External warning 5 (Editable message text) Programmable warning: <a href="#">31.09 External event 5 source</a> <a href="#">31.10 External event 5 type</a>	Fault in external device 5.	Check the external device. Check setting of parameter <a href="#">31.09 External event 5 source</a> .
AF88	Season configuration warning	You have configured a season which starts before the previous season.	Configure the seasons with increasing start dates, see parameters <a href="#">34.60 Season 1 start date...</a> <a href="#">34.63 Season 4 start date</a> .
AF90	Speed controller autotuning	The speed controller autotune routine did not complete successfully.	Check the auxiliary code (format XXXX YYYY). "YYYY" indicates the problem (see actions for each code below).
	0000	The drive was stopped before the autotune routine finished.	Repeat autotune until successful.
	0001	The drive was started but was not ready to follow the autotune command.	Make sure the prerequisites of the autotune run are fulfilled. See section <a href="#">Before activating the autotune routine</a> (page 127).
	0002	Required torque reference could not be reached before the drive reached maximum speed.	Decrease torque step (parameter <a href="#">25.38</a> ) or increase speed step ( <a href="#">25.39</a> ).
	0003	Motor could not accelerate/decelerate to maximum/minimum speed.	Increase torque step (parameter <a href="#">25.38</a> ) or decrease speed step ( <a href="#">25.39</a> ).
	0005	Motor could not decelerate with full autotune torque.	Decrease torque step (parameter <a href="#">25.38</a> ) or speed step ( <a href="#">25.39</a> ).
AFAA	Autoreset	A fault is about to be autoreset.	Informative warning. See the settings in parameter group <a href="#">31 Fault functions</a> .
AFE1	Emergency stop (off2)	Drive has received an emergency stop (mode selection off2) command.	Check that it is safe to continue operation. Then return emergency stop push button to normal position. Restart drive.
AFE2	Emergency stop (off1 or off3)	Drive has received an emergency stop (mode selection off1 or off3) command.	If the emergency stop was unintentional, check the source selected by parameter <a href="#">21.05 Emergency stop source</a> .
AFE9	Start delay	The start delay is active and the drive will start the motor after a predefined delay.	Informative warning. See parameter <a href="#">21.22 Start delay</a> .

Code (hex)	Warning / Aux. code	Cause	What to do
AFEB	Run enable missing	No run enable signal is received.	Check setting of parameter <a href="#">20.12 Run enable 1 source</a> . Switch signal on (for example, in the fieldbus Control Word) or check wiring of selected source.
AFED	Enable to rotate	Signal to rotate has not been received within a fixed time delay of 240 s.	Switch enable to rotate signal on ((for example, in digital inputs). Check the setting of (and source selected by) parameter <a href="#">20.22 Enable to rotate</a> .
AFF6	Identification run	Motor ID run will occur at next start.	Informative warning.
AFF8	Motor heating active	Pre-heating is being performed	Informative warning. Motor pre-heating is active. Current specified by parameter <a href="#">21.16 Pre-heating current</a> is being passed through the motor.
B5A0	STO event Programmable event: <a href="#">31.22 STO indication run/stop</a>	Safe torque off function is active, ie. safety circuit signal(s) connected to connector STO is lost.	Informative warning. Check safety circuit connections. For more information, see chapter <i>The Safe torque off function</i> in the <i>Hardware manual</i> of the drive and description of parameter <a href="#">31.22 STO indication run/stop</a> (page <a href="#">313</a> ).
D501	No more available PFC motors	No more PFC motors can be started because they can be interlocked or in the Hand mode.	Check that there are no interlocked PFC motors, see parameters: <a href="#">76.81...76.84</a> . If all motors are in use, the PFC system is not adequately dimensioned to handle the demand.
D502	All motors interlocked	All the motors in the PFC system are interlocked.	Check that there are no interlocked PFC motors, see parameters <a href="#">76.81...76.84</a> .
D503	VSD controlled PFC motor interlocked	The motor connected to the drive is interlocked (unavailable).	Motor connected to the drive is interlocked and thus cannot be started. Remove the corresponding interlock to start the drive controlled PFC motor. See parameters <a href="#">76.81...76.84</a> .

## Fault messages

Code (hex)	Fault / Aux. code	Cause	What to do
1080	Backup/Restore timeout	Control panel or PC tool has failed to communicate with the drive when backup was being made or restored.	Request backup or restore again.
1081	Rating ID fault	Drive software has not been able to read the rating ID of the drive.	Reset the fault to make the drive try to reread the rating ID. If the fault reappears, cycle the power to the drive. You may have to repeat this. If the fault persists, contact your local ABB representative.
2281	Calibration	Measured offset of output phase current measurement or difference between output phase U2 and W2 current measurement is too great (the values are updated during current calibration).	Try performing the current calibration again (select <a href="#">Current measurement calibration</a> at parameter <a href="#">99.13</a> ). If the fault persists, contact your local ABB representative. Auxiliary codes are shown below.
	0001	Too high offset error in U-phase current.	
	0002	Too high offset error in V-phase current.	
	0003	Too high offset error in W-phase current.	
	0004	Too high gain difference detected between phase current measurements.	
2310	Overcurrent	Output current has exceeded internal fault limit. In addition to an actual overcurrent situation, this fault may also be caused by an earth fault or supply phase loss.	Check motor load. Check acceleration times in parameter group <a href="#">23 Speed reference ramp</a> (speed control), <a href="#">26 Torque reference chain</a> (torque control) or <a href="#">28 Frequency reference chain</a> (frequency control). Also check parameters <a href="#">46.01 Speed scaling</a> , <a href="#">46.02 Frequency scaling</a> and <a href="#">46.03 Torque scaling</a> . Check motor and motor cable (including phasing and delta/star connection). Check there are no contactors opening and closing in motor cable. Check that the start-up data in parameter group 99 corresponds to the motor rating plate. Check that there are no power factor correction capacitors or surge absorbers in motor cable. Check for an earth fault in motor or motor cables by measuring the insulation resistances of motor and motor cable. See chapter <i>Electrical installation</i> , section <i>Checking the insulation of the assembly</i> in the <i>Hardware manual</i> of the drive.

Code (hex)	Fault / Aux. code	Cause	What to do
2330	Earth leakage	Drive has detected load unbalance typically due to earth fault in motor or motor cable.	<p>Check there are no power factor correction capacitors or surge absorbers in motor cable.</p> <p>Check for an earth fault in motor or motor cables by measuring the insulation resistances of motor and motor cable.</p> <p>Try running the motor in scalar control mode if allowed. (See parameter <a href="#">99.04 Motor control mode</a>.)</p> <p>If no earth fault can be detected, contact your local ABB representative.</p>
2340	Short circuit	Short-circuit in motor cable(s) or motor	<p>Check motor and motor cable for cabling errors.</p> <p>Check there are no power factor correction capacitors or surge absorbers in motor cable.</p> <p>Cycle the power to the drive.</p>
	0080	State feedback from output phases does not match control signals. For frames R6 and R7.	
2381	IGBT overload	Excessive IGBT junction to case temperature. This fault protects the IGBT(s) and can be activated by a short circuit in the motor cable.	<p>Check motor cable.</p> <p>Check ambient conditions.</p> <p>Check air flow and fan operation.</p> <p>Check heatsink fins for dust pick-up.</p> <p>Check motor power against drive power.</p>
3130	Input phase loss Programmable fault: <a href="#">31.21 Supply phase loss</a>	Intermediate circuit DC voltage is oscillating due to missing input power line phase or blown fuse.	<p>Check input power line fuses.</p> <p>Check for loose power cable connections.</p> <p>Check for input power supply imbalance.</p>
3181	Wiring or earth fault Programmable fault: <a href="#">31.23 Wiring or earth fault</a>	Incorrect input power and motor cable connection (ie. input power cable is connected to drive motor connection).	<p>Check input power connections.</p>
3210	DC link overvoltage	Excessive intermediate circuit DC voltage.	<p>Check that overvoltage control is on (parameter <a href="#">30.30 Overvoltage control</a>).</p> <p>Check that the supply voltage matches the nominal input voltage of the drive.</p> <p>Check the supply line for static or transient overvoltage.</p> <p>Check brake chopper and resistor (if present).</p> <p>Check deceleration time.</p> <p>Use coast-to-stop function (if applicable).</p> <p>Retrofit drive with brake chopper and brake resistor.</p> <p>Check that the brake resistor is dimensioned properly and the resistance is between acceptable range for the drive.</p>

Code (hex)	Fault / Aux. code	Cause	What to do
3220	DC link undervoltage	Intermediate circuit DC voltage is not sufficient because of a missing supply phase, blown fuse or fault in the rectifier bridge.	Check supply cabling, fuses and switchgear.
3381	Output phase loss Programmable fault: <a href="#">31.19 Motor phase loss</a>	Motor circuit fault due to missing motor connection (all three phases are not connected).	Connect motor cable.
4110	Control board temperature	Control unit temperature is too high.	Check proper cooling of the drive. Check the auxiliary cooling fan.
4210	IGBT overtemperature	Estimated drive IGBT temperature is excessive.	Check ambient conditions. Check air flow and fan operation. Check heatsink fins for dust pick-up. Check motor power against drive power.
4290	Cooling	Drive module temperature is excessive.	Check ambient temperature. If it exceeds 40 °C/104 °F (IP21 frames R4...R9) or if it exceeds 50 °C /122 °F (IP21 frames R1...R9), ensure that load current does not exceed derated load capacity of drive. For all P55 frames, check the derating temperatures. See chapter <i>Technical data</i> , section <i>Derating</i> in the <i>Hardware manual</i> of the drive. Check drive module cooling air flow and fan operation. Check inside of cabinet and heatsink of drive module for dust pick-up. Clean whenever necessary.
42F1	IGBT temperature	Drive IGBT temperature is excessive.	Check ambient conditions. Check air flow and fan operation. Check heatsink fins for dust pick-up. Check motor power against drive power.
4310	Excess temperature	Power unit module temperature is excessive.	See <a href="#">A4B0 Excess temperature</a> (page 484).
4380	Excess temperature difference	High temperature difference between the IGBTs of different phases.	Check the motor cabling. Check cooling of drive module(s).
4981	External temperature 1 (Editable message text)	Measured temperature 1 has exceeded fault limit.	Check the value of parameter <a href="#">35.02 Measured temperature 1</a> . Check the cooling of the motor (or other equipment whose temperature is being measured).
4982	External temperature 2 (Editable message text)	Measured temperature 2 has exceeded fault limit.	Check the value of parameter <a href="#">35.03 Measured temperature 2</a> . Check the cooling of the motor (or other equipment whose temperature is being measured).
4990	CPTC-02 not found	CPTC-02 extension module is not detected in option slot 2.	Power down the drive and check that the module is properly inserted in option slot 2. See also <i>CPTC-02 ATEX-certified thermistor protection module, Ex II (2) GD (+L537+Q971) user's manual</i> (3AXD50000030058 [English]).

Code (hex)	Fault / Aux. code	Cause	What to do
4991	Safe motor temperature	The CPTC-02 module indicates overtemperature: <ul style="list-style-type: none"> <li>• motor temperature is too high, or</li> <li>• the thermistor is in short-circuit or disconnected</li> </ul>	Check the cooling of the motor. Check the motor load and drive ratings. Check the wiring of the temperature sensor. Repair wiring if faulty. Measure the resistance of the sensor. Replace the sensor if faulty.
5080	Fan	Cooling fan feedback missing. For frame sizes R6 or larger.	See <a href="#">A581 Fan</a> (page 484).
5081	Auxiliary fan broken	An auxiliary cooling fan (connected to the fan connectors on the control unit) is stuck or disconnected.	Check the auxiliary code. Check auxiliary fan(s) and connection(s). Replace fan if faulty. Make sure the front cover of the drive is in place and tightened. If the commissioning of the drive requires the cover is off, activate parameter <a href="#">31.36 Aux fan fault function</a> within 2 min from control unit reboot to temporarily suppress the fault. Reboot the control unit (using parameter <a href="#">96.08 Control board boot</a> ) or by cycling power.
	0001	Auxiliary fan 1 broken.	
	0002	Auxiliary fan 2 broken.	
5090	STO hardware failure	STO hardware diagnostics has detected hardware failure.	Contact your local ABB representative for hardware replacement.
5091	Safe torque off Programmable fault: <a href="#">31.22 STO indication run/stop</a>	Safe torque off function is active, that is, safety circuit signal(s) connected to connector STO is broken during start or run.	Check safety circuit connections. For more information, see chapter <i>The Safe torque off function</i> in the <i>Hardware manual</i> of the drive and description of parameter <a href="#">31.22 STO indication run/stop</a> (page 313). Check the value of parameter <a href="#">95.04 Control board supply</a> .
5092	PU logic error	Power unit memory has cleared.	Contact your local ABB representative.
5093	Rating ID mismatch	The hardware of the drive does not match the information stored in the memory. This may occur, for example, after a firmware update.	Cycle the power to the drive. You may have to repeat this.
5094	Measurement circuit temperature	Problem with internal temperature measurement of the drive.	Contact your local ABB representative.
5089	SMT circuit malfunction	Safe motor temperature fault is generated and STO event/fault/warning is not generated. <b>Note:</b> If only one STO channel is opened, fault <a href="#">5090 STO hardware failure</a> is generated.	Check connection between the relay output of the module and the STO terminal.
5098	I/O communication loss	Communication failure to standard I/O.	Try resetting the fault or cycle the power to the drive.



Code (hex)	Fault / Aux. code	Cause	What to do
50A0	Fan	Cooling fan stuck or disconnected.	Check fan operation and connection. Replace fan if faulty.
5681	PU communication	Communication errors detected between the drive control unit and the power unit.	Check the connection between the drive control unit and the power unit. Check the value of parameter <a href="#">95.04 Control board supply</a> .
5682	Power unit lost	Connection between the drive control unit and the power unit is lost.	Check the connection between the control unit and the power unit.
5691	Measurement circuit ADC	Measurement circuit fault.	Contact your local ABB representative.
5692	PU board powerfail	Power unit power supply failure.	Contact your local ABB representative.
5693	Measurement circuit DFF	Measurement circuit fault.	Contact your local ABB representative.
5697	Charging feedback	Charging feedback signal missing.	Check the feedback signal coming from the charging system
5698	Unknown PU fault	The power unit logic has generated a fault which is not known by the software.	Check the logic and software compatibility.
6181	FPGA version incompatible	Firmware and FPGA versions are incompatible.	Reboot the control unit (using parameter <a href="#">96.08 Control board boot</a> ) or by cycling power. If the problem persists, contact your local ABB representative
6200	Checksum mismatch	Parameter checksum <a href="#">96.68 Actual checksumA</a> does not match <a href="#">96.71 Approved checksum A</a> and/ or parameter checksum <a href="#">96.69 Actual checksumB</a> does not match <a href="#">96.72 Approved checksum B</a> .	Revert parameter changes made after approving the checksum. If parameter changes are valid, approve new checksum by setting parameter <a href="#">96.55 Checksum control word</a> bit 12 ( <a href="#">Set approved checksum A</a> ) and/or 13 ( <a href="#">Set approved checksum B</a> ) to 1 = Set.
6306	FBA A mapping file	Fieldbus adapter A mapping file read error.	Contact your local ABB representative.
6481	Task overload	Internal fault.	Reboot the control unit (using parameter <a href="#">96.08 Control board boot</a> ) or by cycling power. If the problem persists, contact your local ABB representative
6487	Stack overflow	Internal fault.	Reboot the control unit (using parameter <a href="#">96.08 Control board boot</a> ) or by cycling power. If the problem persists, contact your local ABB representative
64A1	Internal file load	File read error.	Reboot the control unit (using parameter <a href="#">96.08 Control board boot</a> ) or by cycling power. If the problem persists, contact your local ABB representative
64A4	Rating ID fault	Rating ID load error.	Contact your local ABB representative.

Code (hex)	Fault / Aux. code	Cause	What to do
64A6	Adaptive program	Error running the adaptive program.	Check the auxiliary code (format XXYY ZZZZ). "XX" specifies the number of the state (00=base program) and "YY" specifies the number of the function block (0000=generic error). "ZZZZ" indicates the problem.
	000A	Program corrupted or block non-existent	Restore the template program or download the program to the drive.
	000C	Required block input missing	Check the inputs of the block.
	000E	Program corrupted or block non-existent	Restore the template program or download the program to the drive.
	0011	Program too large.	Remove blocks until the error stops.
	0012	Program is empty.	Correct the program and download it to the drive.
	001C	A non-existing parameter or block is used in the program.	Edit the program to correct the parameter reference, or to use an existing block.
	001D	Parameter type invalid for selected pin.	Edit the program to correct the parameter reference.
	001E	Output to parameter failed because the parameter was write-protected.	Check the parameter reference in the program. Check for other sources affecting the target parameter.
	0023	Program file incompatible with current firmware version.	Adapt the program to current block library and firmware version.
	0024		
	Other	–	Contact your local ABB representative, quoting the auxiliary code.
64B1	Internal SSW fault	Internal fault.	Reboot the control unit (using parameter <a href="#">96.08 Control board boot</a> ) or by cycling power. If the problem persists, contact your local ABB representative.
64B2	User set fault	Loading of user parameter set failed because <ul style="list-style-type: none"> <li>• requested set does not exist</li> <li>• set is not compatible with control program</li> <li>• drive was switched off during loading.</li> </ul>	Ensure that a valid user parameter set exists. Reload if uncertain.
64B3	Macro parameterization error	Macro parameterization failed, for example, because parameter default value that cannot be changed has been attempted to write.	
64E1	Kernel overload	Operating system error.	Reboot the control unit (using parameter <a href="#">96.08 Control board boot</a> ) or by cycling power. If the problem persists, contact your local ABB representative.
6581	Parameter system	Parameter load or save failed.	Try forcing a save using parameter <a href="#">96.07 Parameter save manually</a> . Retry.

Code (hex)	Fault / Aux. code	Cause	What to do
6591	Backup/Restore timeout	During backup creating or restoring operation a control panel or PC-tool has failed to communicate with the drive as part this operation.	Check control panel or PC-tool communication and if it is still in backup or restore state.
65A1	FBA A parameter conflict	The drive does not have a functionality requested by PLC, or requested functionality has not been activated.	Check PLC programming. Check settings of parameter groups <a href="#">50 Fieldbus adapter (FBA)</a> and <a href="#">51 FBA A settings</a> .
6681	EFB comm loss Programmable fault: <a href="#">58.14 Communication loss action</a>	Communication break in embedded fieldbus (EFB) communication.	Check the status of the fieldbus master (online/offline/error etc.). Check cable connections to the EIA-485/X5 terminals 29, 30 and 31 on the control unit.
6682	EFB config file	Embedded fieldbus (EFB) configuration file could not be read.	Contact your local ABB representative.
6683	EFB invalid parameterization	Embedded fieldbus (EFB) parameter settings inconsistent or not compatible with selected protocol.	Check the settings in parameter group <a href="#">58 Embedded fieldbus</a> .
6684	EFB load fault	Embedded fieldbus (EFB) protocol firmware could not be loaded. Version mismatch between EFB protocol firmware and drive firmware.	Contact your local ABB representative.
6685	EFB fault 2	Fault reserved for the EFB protocol application.	Check the documentation of the protocol.
6686	EFB fault 3	Fault reserved for the EFB protocol application.	Check the documentation of the protocol.
6882	Text 32-bit table overflow	Internal fault.	Reset the fault. Contact your local ABB representative if the fault persists.
6885	Text file overflow	Internal fault.	Reset the fault. Contact your local ABB representative if the fault persists.
7081	Control panel loss Programmable fault: <a href="#">49.05 Communication loss action</a>	Control panel or PC tool selected as active control location for drive has ceased communicating.	Check PC tool or control panel connection. Check control panel connector. Disconnect and reconnect the control panel.
7085	Incompatible option module	Fieldbus option module not supported.	Replace the module with a supported type.
7086	I/O module AI Overvoltage	Overvoltage detected in AI. AI is changed to voltage mode. AI will return automatically back to mA mode when the AI signal level is in accepted limits.	Check AI signal levels.
7121	Motor stall Programmable fault: <a href="#">31.24 Stall function</a>	Motor is operating in stall region because of, for example, excessive load or insufficient motor power.	Check motor load and drive ratings. Check fault function parameters.

Code (hex)	Fault / Aux. code	Cause	What to do
7122	Motor overload	Motor current is too high.	Check for overloaded motor. Adjust the parameters used for the motor overload function ( <a href="#">35.51...35.53</a> ) and <a href="#">35.55...35.56</a> .
7181	Brake resistor	Brake resistor broken or not connected.	Check that a brake resistor has been connected. Check the condition of the brake resistor. Check the dimensioning of the brake resistor.
7183	BR excess temperature	Brake resistor temperature has exceeded fault limit defined by parameter <a href="#">43.11 Brake resistor fault limit</a> .	Stop drive. Let resistor cool down. Check resistor overload protection function settings (parameter group <a href="#">43 Brake chopper</a> ). Check fault limit setting, parameter <a href="#">43.11 Brake resistor fault limit</a> . Check that braking cycle meets allowed limits.
7184	Brake resistor wiring	Brake resistor short circuit or brake chopper control fault.	Check brake chopper and brake resistor connection. Ensure brake resistor is not damaged.
7191	BC short circuit	Short circuit in brake chopper IGBT.	Ensure brake resistor is connected and not damaged. Check the electrical specifications of the brake resistor against chapter <i>Resistor braking</i> in the <i>Hardware manual</i> of the drive. Replace brake chopper (if replaceable).
7192	BC IGBT excess temperature	Brake chopper IGBT temperature has exceeded internal fault limit.	Let chopper cool down. Check for excessive ambient temperature. Check for cooling fan failure. Check for obstructions in the air flow. Check resistor overload protection function settings (parameter group <a href="#">43 Brake chopper</a> ). Check that braking cycle meets allowed limits. Check that drive supply AC voltage is not excessive.
7310	Overspeed	Motor is turning faster than highest allowed speed due to incorrectly set minimum/maximum speed, insufficient braking torque or changes in load when using torque reference.	Check minimum/maximum speed settings, parameters <a href="#">30.11 Minimum speed</a> and <a href="#">30.12 Maximum speed</a> . Check adequacy of motor braking torque. Check applicability of torque control. Check need for brake chopper and resistor(s).
73B0	Emergency ramp failed	Emergency stop did not finish within expected time.	Check the settings of parameters <a href="#">31.32 Emergency ramp supervision</a> and <a href="#">31.33 Emergency ramp supervision delay</a> . Check the predefined ramp times ( <a href="#">23.11...23.15</a> for mode Off1, <a href="#">23.23</a> for mode Off3).
73F0	Overfrequency	Maximum allowed output frequency exceeded.	Check the auxiliary code.

Code (hex)	Fault / Aux. code	Cause	What to do
	00FA	Motor is turning faster than the highest allowed frequency due to incorrectly set minimum/maximum frequency or the motor rushes because of too high supply voltage or incorrect supply voltage selection in parameter <a href="#">95.01 Supply voltage</a> .	Check minimum/maximum frequency settings, parameters <a href="#">30.13 Minimum frequency</a> and <a href="#">30.14 Maximum frequency</a> . Check used supply voltage and voltage selection parameter <a href="#">95.01 Supply voltage</a> .
	Other	-	Contact your local ABB representative, quoting the auxiliary code.
7510	FBA A communication Programmable fault: <a href="#">50.02 FBA A comm loss func</a>	Cyclical communication between drive and fieldbus adapter module A or between PLC and fieldbus adapter module A is lost.	Check status of fieldbus communication. See user documentation of fieldbus interface. Check settings of parameter groups <a href="#">50 Fieldbus adapter (FBA)</a> , <a href="#">51 FBA A settings</a> , <a href="#">52 FBA A data in</a> and <a href="#">53 FBA A data out</a> . Check cable connections. Check if communication master is able to communicate.
8001	ULC underload fault	User load curve: Signal has been too long under the underload curve.	See parameter <a href="#">37.04 ULC underload actions</a> .
8002	ULC overload fault	User load curve: Signal has been too long over the overload curve.	See parameter <a href="#">37.03 ULC overload actions</a> .
80A0	AI supervision Programmable fault: <a href="#">12.03 AI supervision function</a>	An analog signal is outside the limits specified for the analog input.	Check signal level at the analog input. Check the auxiliary code. Check the wiring connected to the input. Check the minimum and maximum limits of the input in parameter group <a href="#">12 Standard AI</a> .
	0001	AI1LessMIN	
	0002	AI1GreaterMAX	
	0003	AI2LessMIN.	
	0004	AI2GreaterMAX	
80B0	Signal supervision 1 (Editable message text) Programmable fault: <a href="#">32.06 Supervision 1 action</a>	Fault generated by the signal supervision function 1.	Check the source of the fault (parameter <a href="#">32.07 Supervision 1 signal</a> ).
80B1	Signal supervision 2 (Editable message text) Programmable fault: <a href="#">32.16 Supervision 2 action</a>	Fault generated by the signal supervision function 2.	Check the source of the fault (parameter <a href="#">32.17 Supervision 2 signal</a> ).
80B2	Signal supervision 3 (Editable message text) Programmable fault: <a href="#">32.26 Supervision 3 action</a>	Fault generated by the signal supervision function 3.	Check the source of the fault (parameter <a href="#">32.27 Supervision 3 signal</a> ).
80B3	Signal supervision 4 (Editable message text) Programmable fault: <a href="#">32.36 Supervision 4 action</a>	Fault generated by the signal supervision function 4.	Check the source of the fault (parameter <a href="#">32.37 Supervision 4 signal</a> ).

## 502 Fault tracing

Code (hex)	Fault / Aux. code	Cause	What to do
80B4	Signal supervision 5 (Editable message text) Programmable fault: <a href="#">32.46 Supervision 5 action</a>	Fault generated by the signal supervision function 5.	Check the source of the fault (parameter <a href="#">32.47 Supervision 5 signal</a> ).
80B5	Signal supervision 6 (Editable message text) Programmable fault: <a href="#">32.56 Supervision 6 action</a>	Fault generated by the signal supervision function 6.	Check the source of the fault (parameter <a href="#">32.57 Supervision 6 signal</a> ).
9081	External fault 1 (Editable message text) Programmable fault: <a href="#">31.01 External event 1 source</a> <a href="#">31.02 External event 1 type</a>	Fault in external device 1.	Check the external device. Check setting of parameter <a href="#">31.01 External event 1 source</a> .
9082	External fault 2 (Editable message text) Programmable fault: <a href="#">31.03 External event 2 source</a> <a href="#">31.04 External event 2 type</a>	Fault in external device 2.	Check the external device. Check setting of parameter <a href="#">31.03 External event 2 source</a> .
9083	External fault 3 (Editable message text) Programmable fault: <a href="#">31.05 External event 3 source</a> <a href="#">31.06 External event 3 type</a>	Fault in external device 3.	Check the external device. Check setting of parameter <a href="#">31.05 External event 3 source</a> .
9084	External fault 4 (Editable message text) Programmable fault: <a href="#">31.07 External event 4 source</a> <a href="#">31.08 External event 4 type</a>	Fault in external device 4.	Check the external device. Check setting of parameter <a href="#">31.07 External event 4 source</a> .
9085	External fault 5 (Editable message text) Programmable fault: <a href="#">31.09 External event 5 source</a> <a href="#">31.10 External event 5 type</a>	Fault in external device 5.	Check the external device. Check setting of parameter <a href="#">31.09 External event 5 source</a> .
FA81	Safe torque off 1	Safe torque off function is active, ie. STO circuit 1 is broken.	Check safety circuit connections. For more information, see chapter <i>The Safe torque off function</i> in the <i>Hardware manual</i> of the drive and description of parameter <a href="#">31.22 STO indication run/stop</a> (page <a href="#">313</a> ). Check the value of parameter <a href="#">95.04 Control board supply</a> .
FA82	Safe torque off 2	Safe torque off function is active, ie. STO circuit 2 is broken.	

Code (hex)	Fault / Aux. code	Cause	What to do
FF61	ID run	Motor ID run was not completed successfully.	<p>Check the nominal motor values in parameter group <a href="#">99 Motor data</a>.</p> <p>Check that no external control system is connected to the drive.</p> <p>Cycle the power to the drive (and its control unit, if powered separately).</p> <p>Check that no operation limits prevent the completion of the ID run. Restore parameters to default settings and try again.</p> <p>Check that the motor shaft is not locked.</p> <p>Check the auxiliary code. The second number of the code indicates the problem (see actions for each code below).</p>
	0001	Maximum current limit too low.	<p>Check settings of parameters <a href="#">99.06 Motor nominal current</a> and <a href="#">30.17 Maximum current</a>. Make sure that <math>30.17 &gt; 99.06</math>.</p> <p>Check that the drive is dimensioned correctly according to the motor.</p>
	0002	Maximum speed limit or calculated field weakening point too low.	<p>Check settings of parameters</p> <ul style="list-style-type: none"> <li>• <a href="#">30.11 Minimum speed</a></li> <li>• <a href="#">30.12 Maximum speed</a></li> <li>• <a href="#">99.07 Motor nominal voltage</a></li> <li>• <a href="#">99.08 Motor nominal frequency</a></li> <li>• <a href="#">99.09 Motor nominal speed</a>.</li> </ul> <p>Make sure that</p> <ul style="list-style-type: none"> <li>• <math>30.12 &gt; (0.55 \times 99.09) &gt; (0.50 \times \text{synchronous speed})</math></li> <li>• <math>30.11 \leq 0</math>, and</li> <li>• supply voltage <math>\geq (0.66 \times 99.07)</math>.</li> </ul>
	0003	Maximum torque limit too low.	<p>Check settings of parameter <a href="#">99.12 Motor nominal torque</a>, and the torque limits in group <a href="#">30 Limits</a>.</p> <p>Make sure that the maximum torque limit in force is greater than 100%.</p>
	0004	Current measurement calibration did not finish within reasonable time	Contact your local ABB representative.
	0005	Motor not connected to the drive.	Check the motor connection.
	0006...0008	Internal error.	Contact your local ABB representative.
	0009	(Asynchronous motors only) Acceleration did not finish within reasonable time.	Contact your local ABB representative.
	000A	(Asynchronous motors only) Deceleration did not finish within reasonable time.	Contact your local ABB representative.
	000B	(Asynchronous motors only) Speed dropped to zero during ID run.	Contact your local ABB representative.

## 504 Fault tracing

Code (hex)	Fault / Aux. code	Cause	What to do
	000C	(Permanent magnet motors only) First acceleration did not finish within reasonable time.	Contact your local ABB representative.
	000D	(Permanent magnet motors only) Second acceleration did not finish within reasonable time.	Contact your local ABB representative.
	000E...0010	Internal error.	Contact your local ABB representative.
	0011	(Synchronous reluctance motors only) Pulse test error.	Contact your local ABB representative.
	0012	Motor too large for advanced standstill ID run.	Check that the motor and drive sizes are compatible. Contact your local ABB representative.
	0013	(Asynchronous motors only) Motor data error.	Check that the motor nominal value settings in the drive are the same as in the motor nameplate. Contact your local ABB representative.
FF63	STO diagnostics failure.	SW internal malfunction.	Reboot the control unit (using parameter <a href="#">96.08 Control board boot</a> ) or by cycling power.
FF81	FB A force trip	A fault trip command has been received through fieldbus adapter A.	Check the fault information provided by the PLC.
FF8E	EFB force trip	A fault trip command has been received through the embedded fieldbus interface.	Check the fault information provided by the PLC.



# 10

## Fieldbus control through the embedded fieldbus interface (EFB)

---

### What this chapter contains

The chapter describes how the drive can be controlled by external devices over a communication network (fieldbus) using the embedded fieldbus interface.

### System overview

The drive can be connected to an external control system through a communication link using either a fieldbus adapter or the embedded fieldbus interface.

The embedded fieldbus interface supports the Modbus RTU protocol. The drive control program can handle 10 Modbus registers in a 10-millisecond time level. For example, if the drive receives a request to read 20 registers, it will start its response within 22 ms of receiving the request – 20 ms for processing the request and 2 ms overhead for handling the bus. The actual response time depends on other factors as well, such as the baud rate (a parameter setting in the drive).

The drive can be set to receive all of its control information through the fieldbus interface, or the control can be distributed between the embedded fieldbus interface and other available sources, for example, digital and analog inputs.

---

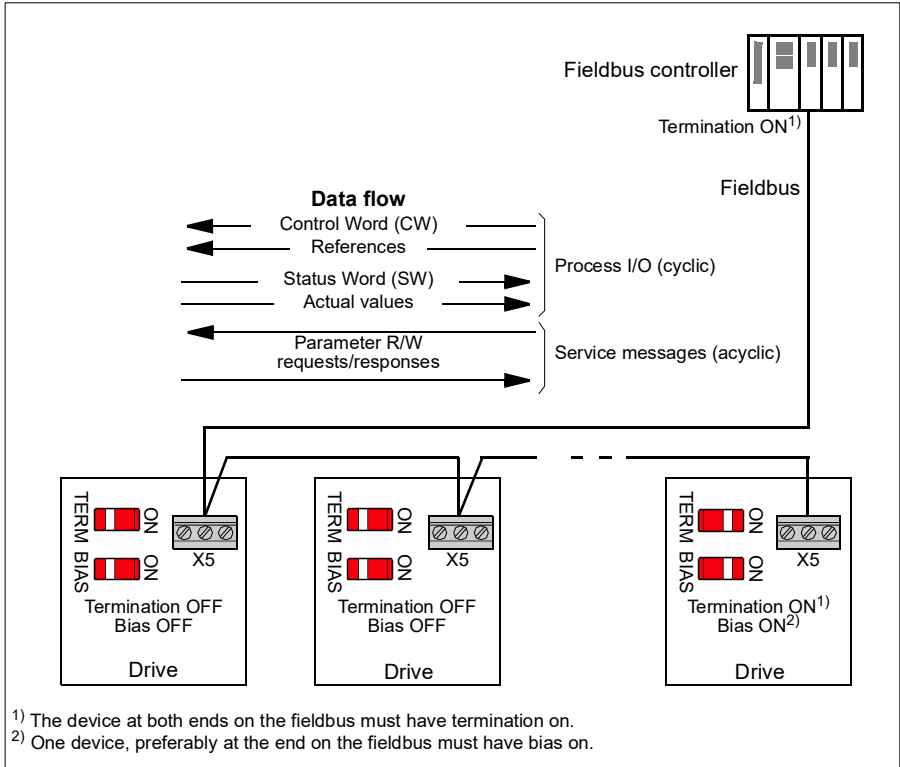

## Connecting the drive to the fieldbus

Connect terminal block X5 on the control unit of the drive to the fieldbus. The connection diagram is shown below.

Use preferably three conductors and a shield for the connection.

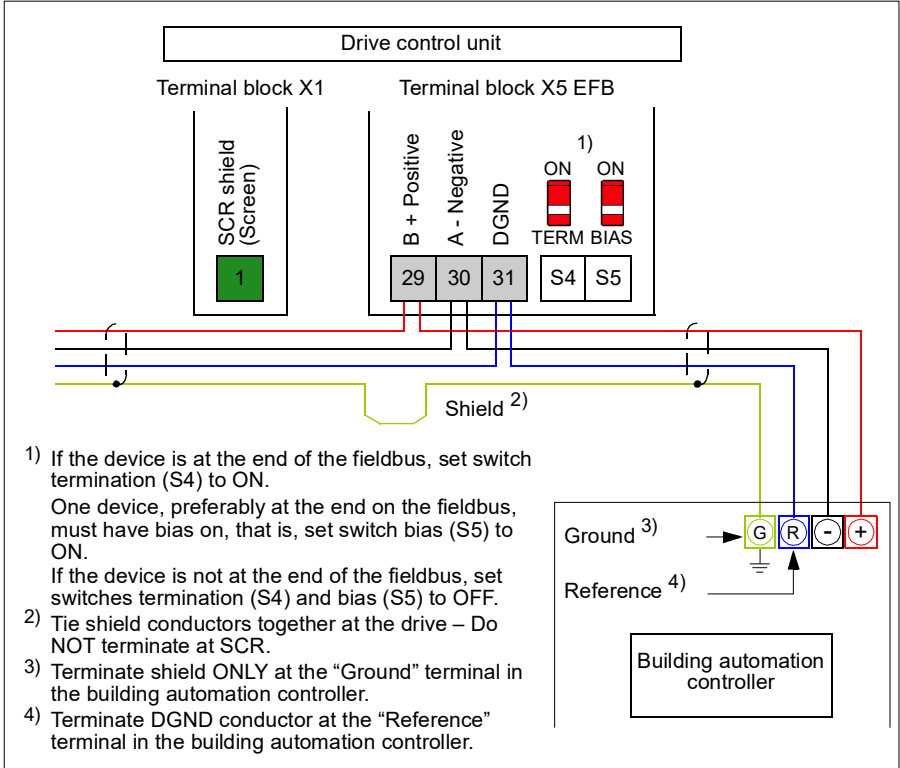

## Setting up the embedded fieldbus interface

Set the drive up for the embedded fieldbus communication with the parameters shown in the table below. The **Setting for fieldbus control** column gives either the value to use or the default value. The **Function/Information** column gives a description of the parameter.

Parameter	Setting for fieldbus control	Function/Information
COMMUNICATION INITIALIZATION		
<i>58.01 Protocol enable</i>	<i>Modbus RTU</i>	Initializes embedded fieldbus communication.
EMBEDDED MODBUS CONFIGURATION		
<i>58.03 Node address</i>	1 (default)	Node address. There must be no two nodes with the same node address online.
<i>58.04 Baud rate</i>	<i>19.2 kbps</i> (default)	Defines the communication speed of the link. Use the same setting as in the master station.
<i>58.05 Parity</i>	<i>8 EVEN 1</i> (default)	Selects the parity and stop bit setting. Use the same setting as in the master station.
<i>58.14 Communication loss action</i>	<i>Fault</i> (default)	Defines the action taken when a communication loss is detected.
<i>58.15 Communication loss mode</i>	<i>Cw / Ref1 / Ref2</i> (default)	Enables/disables communication loss monitoring and defines the means for resetting the counter of the communication loss delay.
<i>58.16 Communication loss time</i>	3.0 s (default)	Defines the timeout limit for the communication monitoring.
<i>58.17 Transmit delay</i>	0 ms (default)	Defines a response delay for the drive.
<i>58.25 Control profile</i>	<i>ABB Drives</i> (default)	Selects the control profile used by the drive. See section <i>Basics of the embedded fieldbus interface</i> (page 511).
<i>58.26 EFB ref1 type</i> <i>58.27 EFB ref2 type</i>	<i>Speed or frequency</i> (default for <i>58.26</i> ), <i>Transparent, General, Torque</i> (default for <i>58.27</i> ), <i>Speed, Frequency</i>	Defines the types of fieldbus references 1 and 2. The scaling for each reference type is defined by parameters <i>46.01...46.03</i> . With the <i>Speed or frequency</i> setting, the type is selected automatically according to the currently active drive control mode.
<i>58.28 EFB act1 type</i> <i>58.29 EFB act2 type</i>	<i>Speed or frequency</i> (default for <i>58.28</i> ), <i>Transparent</i> (default for <i>58.29</i> ), <i>General, Torque, Speed, Frequency</i>	Defines the types of actual values 1 and 2. The scaling for each actual value type is defined by parameters <i>46.01...46.03</i> . With the <i>Speed or frequency</i> setting, the type is selected automatically according to the currently active drive control mode.

Parameter	Setting for fieldbus control	Function/Information
58.31 <i>EFB act1 transparent source</i> 58.32 <i>EFB act2 transparent source</i>	<i>Other</i>	Defines the source of actual values 1 and 2 when the <i>58.26 EFB ref1 type (58.27 EFB ref2 type)</i> is set to <i>Transparent</i> .
58.33 <i>Addressing mode</i>	<i>Mode 0</i> (default)	Defines the mapping between parameters and holding registers in the 400001...465536 (100...65535) Modbus register range.
58.34 <i>Word order</i>	<i>LO-HI</i> (default)	Defines the order of the data words in the Modbus message frame.
58.101 <i>Data I/O 1</i> ... 58.114 <i>Data I/O 14</i>	For example, the default settings (I/Os 1...6 contain the control word, the status word, two references and two actual values)  <i>RO/DIO control word, AO1 data storage, AO2 data storage, Feedback data storage, Setpoint data storage</i>	Defines the address of the drive parameter which the Modbus master accesses when it reads from or writes to the register address corresponding to Modbus In/Out parameters. Select the parameters that you want to read or write through the Modbus I/O words.  These settings write the incoming data into storage parameters <i>10.99 RO/DIO control word, 13.91 AO1 data storage, 13.92 AO2 data storage, 40.91 Feedback data storage</i> or <i>40.92 Setpoint data storage</i> .
58.06 <i>Communication control</i>	<i>Refresh settings</i>	Validates the settings of the configuration parameters.

The new settings will take effect when the drive is powered up the next time, or when they are validated by parameter *58.06 Communication control (Refresh settings)*.

## Setting the drive control parameters

After the embedded fieldbus interface has been set up, check and adjust the drive control parameters listed in the table below. The **Setting for fieldbus control** column gives the value or values to use when the embedded fieldbus signal is the desired source or destination for that particular drive control signal. The **Function/Information** column gives a description of the parameter.

Parameter	Setting for fieldbus control	Function/Information
CONTROL COMMAND SOURCE SELECTION		
<i>20.01 Ext1 commands</i>	<i>Embedded fieldbus</i>	Selects fieldbus as the source for the start and stop commands when EXT1 is selected as the active control location.

<b>Parameter</b>	<b>Setting for fieldbus control</b>	<b>Function/Information</b>
<a href="#">20.06 Ext2 commands</a>	<i>Embedded fieldbus</i>	Selects fieldbus as the source for the start and stop commands when EXT2 is selected as the active control location.
<b>SPEED REFERENCE SELECTION</b>		
<a href="#">22.11 Ext1 speed ref1</a>	<i>EFB ref1</i>	Selects a reference received through the embedded fieldbus interface as speed reference 1.
<a href="#">22.18 Ext2 speed ref1</a>	<i>EFB ref1</i>	Selects a reference received through the embedded fieldbus interface as speed reference 2.
<b>TORQUE REFERENCE SELECTION</b>		
<a href="#">26.11 Torque ref1 source</a>	<i>EFB ref1</i>	Selects a reference received through the embedded fieldbus interface as torque reference 1.
<a href="#">26.12 Torque ref2 source</a>	<i>EFB ref1</i>	Selects a reference received through the embedded fieldbus interface as torque reference 2.
<b>FREQUENCY REFERENCE SELECTION</b>		
<a href="#">28.11 Ext1 frequency ref1</a>	<i>EFB ref1</i>	Selects a reference received through the embedded fieldbus interface as frequency reference 1.
<a href="#">28.15 Ext2 frequency ref1</a>	<i>EFB ref1</i>	Selects a reference received through the embedded fieldbus interface as frequency reference 2.
<b>OTHER SELECTIONS</b>		
EFB references can be selected as the source at virtually any signal selector parameter by selecting <i>Other</i> , then either <a href="#">03.09 EFB reference 1</a> or <a href="#">03.10 EFB reference 2</a> .		
<b>SYSTEM CONTROL INPUTS</b>		
<a href="#">96.07 Parameter save manually</a>	<i>Save</i> (reverts to <i>Done</i> )	Saves parameter value changes (including those made through fieldbus control) to permanent memory.

## Basics of the embedded fieldbus interface

The cyclic communication between a fieldbus system and the drive consists of 16-bit data words or 32-bit data words (with a transparent control profile).

The diagram below illustrates the operation of the embedded fieldbus interface. The signals transferred in the cyclic communication are explained further below the diagram.

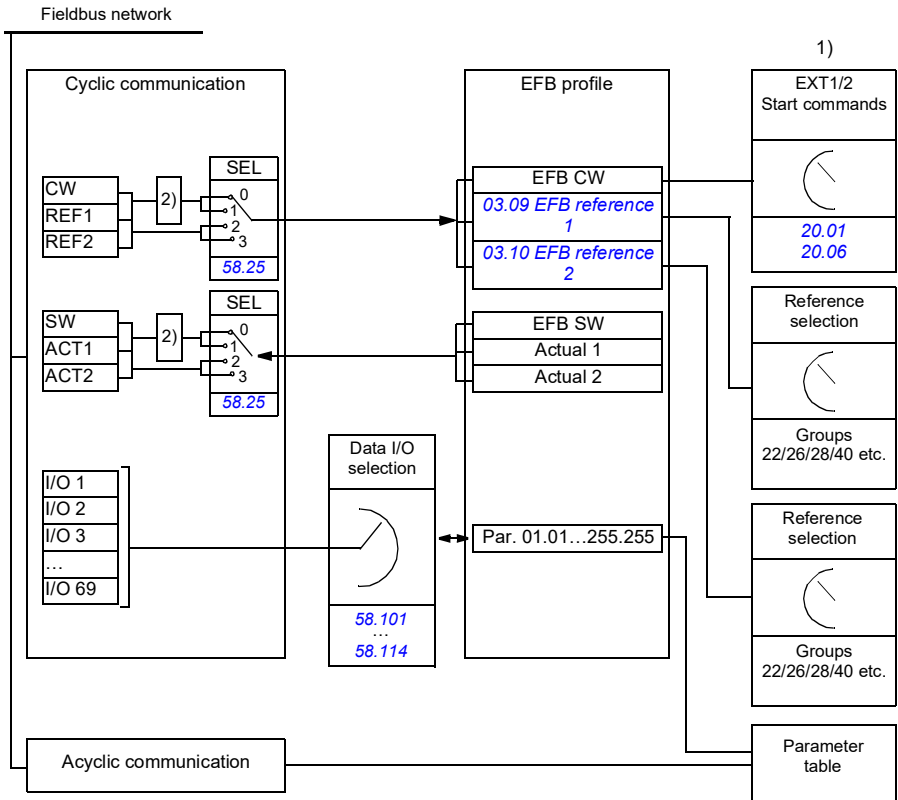

1) See also other parameters which can be controlled through fieldbus.

2) Data conversion if parameter 58.25 Control profile is set to ABB Drives. See section About the control profiles (page 514).

## ■ Control word and Status word

The Control Word (CW) is a 16-bit or 32-bit packed boolean word. It is the principal means of controlling the drive from a fieldbus system. The CW is sent by the fieldbus controller to the drive. With drive parameters, the user selects the EFB CW as the source of drive control commands (such as start/stop, emergency stop, selection between external control locations 1/2, or fault reset). The drive switches between its states according to the bit-coded instructions of the CW.

The fieldbus CW is either written to the drive as it is or the data is converted. See section [About the control profiles](#) (page 514).

The fieldbus Status Word (SW) is a 16-bit or 32-bit packed boolean word. It contains status information from the drive to the fieldbus controller. The drive SW is either written to the fieldbus SW as it is or the data is converted. See section [About the control profiles](#) (page 514).

## ■ References

EFB references 1 and 2 are 16-bit or 32-bit signed integers. The contents of each reference word can be used as the source of virtually any signal, such as the speed, frequency, torque or process reference. In embedded fieldbus communication, references 1 and 2 are displayed by [03.09 EFB reference 1](#) and [03.10 EFB reference 2](#) respectively. Whether the references are scaled or not depends on the settings of [58.26 EFB ref1 type](#) and [58.27 EFB ref2 type](#). See section [About the control profiles](#) (page 514).

## ■ Actual values

Fieldbus actual signals (ACT1 and ACT2) are 16-bit or 32-bit signed integers. They convey selected drive parameter values from the drive to the master. Whether the actual values are scaled or not depends on the settings of [58.28 EFB act1 type](#) and [58.29 EFB act2 type](#). See section [About the control profiles](#) (page 514).

## ■ Data input/outputs

Data input/outputs are 16-bit or 32-bit words containing selected drive parameter values. Parameters [58.101 Data I/O 1 ... 58.114 Data I/O 14](#) define the addresses from which the master either reads data (input) or to which it writes data (output).

## ■ Register addressing

The address field of Modbus requests for accessing holding registers is 16 bits. This allows the Modbus protocol to support addressing of 65536 holding registers.

Historically, Modbus master devices used 5-digit decimal addresses from 40001 to 49999 to represent holding register addresses. The 5-digit decimal addressing limited to 9999 the number of holding registers that could be addressed.

---



Modern Modbus master devices typically provide a means to access the full range of 65536 Modbus holding registers. One of these methods is to use 6-digit decimal addresses from 400001 to 465536. This manual uses 6-digit decimal addressing to represent Modbus holding register addresses.

Modbus master devices that are limited to the 5-digit decimal addressing may still access registers 400001 to 409999 by using 5-digit decimal addresses 40001 to 49999. Registers 410000-465536 are inaccessible to these masters.

See parameter [58.33 Addressing mode](#).

**Note:** Register addresses of 32-bit parameters cannot be accessed by using 5-digit register numbers.

## About the control profiles

A control profile defines the rules for data transfer between the drive and the fieldbus master, for example:

- if packed boolean words are converted and how
- if signal values are scaled and how
- how drive register addresses are mapped for the fieldbus master.

You can configure the drive to receive and send messages according to one of the two profiles:

- [ABB Drives](#)
- [DCU Profile](#).

For the ABB Drives profile, the embedded fieldbus interface of the drive converts the fieldbus data to and from the native data used in the drive. The DCU Profile involves no data conversion or scaling. The figure below illustrates the effect of the profile selection.

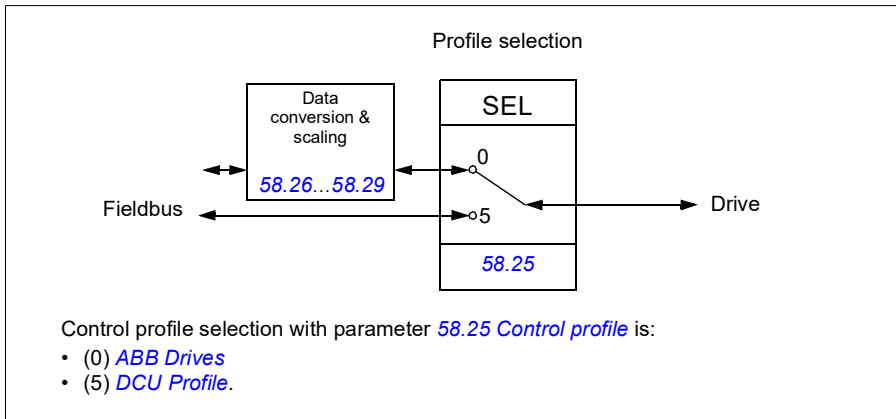

## Control Word

### ■ Control Word for the ABB Drives profile

The table below shows the contents of the fieldbus Control Word for the ABB Drives control profile. The embedded fieldbus interface converts this word to the form in which it is used in the drive. The upper case boldface text refers to the states shown in *State transition diagram for the ABB Drives profile* on page 522.

Bit	Name	Value	STATE/Description
0	OFF1_ CONTROL	1	Proceed to READY TO OPERATE.
		0	Stop along currently active deceleration ramp. Proceed to <b>OFF1 ACTIVE</b> ; proceed to <b>READY TO SWITCH ON</b> unless other interlocks (OFF2, OFF3) are active.
1	OFF2_ CONTROL	1	Continue operation (OFF2 inactive).
		0	Emergency OFF, coast to stop. Proceed to <b>OFF2 ACTIVE</b> , proceed to <b>SWITCH-ON INHIBITED</b> .
2	OFF3_ CONTROL	1	Continue operation (OFF3 inactive).
		0	Emergency stop, stop within time defined by drive parameter. Proceed to <b>OFF3 ACTIVE</b> ; proceed to <b>SWITCH-ON INHIBITED</b> . <b>Warning:</b> Ensure that the motor and driven machine can be stopped using this stop mode.
3	INHIBIT_ OPERATION	1	Proceed to <b>OPERATION ENABLED</b> . <b>Note:</b> Run enable signal must be active; see the drive documentation. If the drive is set to receive the Run enable signal from the fieldbus, this bit activates the signal. See also parameter <i>06.18 Start inhibit status word</i> (page 212).
		0	Inhibit operation. Proceed to <b>OPERATION INHIBITED</b> .
4	RAMP_OUT_ ZERO	1	Normal operation. Proceed to <b>RAMP FUNCTION GENERATOR: OUTPUT ENABLED</b> .
		0	Force Ramp Function Generator output to zero. Drive ramps to stop (current and DC voltage limits in force).
5	RAMP_HOLD	1	ramp function. Proceed to <b>RAMP FUNCTION GENERATOR: ACCELERATOR ENABLED</b> .
		0	Halt ramping (Ramp Function Generator output held).
6	RAMP_IN_ ZERO	1	Normal operation. Proceed to <b>OPERATING</b> . <b>Note:</b> This bit is effective only if the fieldbus interface is set as the source for this signal by drive parameters.
		0	Force Ramp Function Generator input to zero.

Bit	Name	Value	STATE/Description
7	RESET	0=>1	Fault reset if an active fault exists. Proceed to <b>SWITCH-ON INHIBITED</b> . <b>Note:</b> This bit is effective only if the fieldbus interface is set as the source for this signal by drive parameters.
		0	Continue normal operation.
8	JOGGING_1	1	Request running at Jogging 1 speed. <b>Note:</b> This bit is effective only if the fieldbus interface is set as the source for this signal by drive parameters.
		0	Continue normal operation.
9	JOGGING_2	1	Request running at Jogging 2 speed. <b>Note:</b> This bit is effective only if the fieldbus interface is set as the source for this signal by drive parameters.
		0	Continue normal operation.
10	REMOTE_CMD	1	Fieldbus control d.
		0	Control Word <> 0 or Reference <> 0: Retain last Control Word and Reference. Control Word = 0 and Reference = 0: Fieldbus control d. Reference and deceleration/acceleration ramp are locked.
11	EXT_CTRL_LOC	1	Select External Control Location EXT2. Effective if the control location is parameterized to be selected from the fieldbus.
		0	Select External Control Location EXT1. Effective if the control location is parameterized to be selected from the fieldbus.
12	USER_0		Writable control bits that can be combined with drive logic for application-specific functionality.
13	USER_1		
14	USER_2		
15	USER_3		

### ■ Control Word for the DCU Profile

The embedded fieldbus interface writes the fieldbus Control Word as is to the drive Control Word bits 0 to 15. Bits 16 to 32 of the drive Control Word are not in use.

Bit	Name	Value	State/Description
0	STOP	1	Stop according to the Stop Mode parameter or the stop mode request bits (bits 7...9).
		0	(no op)
1	START	1	Start the drive.
		0	(no op)

Bit	Name	Value	State/Description
2	REVERSE	1	Reverse direction of motor rotation.
		0	Direction of motor rotation depends on the sign of reference: Positive reference: Forward Negative reference: Reverse.
3	Reserved		
4	RESET	0=>1	Fault reset if an active fault exists.
		0	(no op)
5	EXT2	1	Select External control location EXT2. Effective if the control location is parameterized to be selected from the fieldbus.
		0	Select External control location EXT1. Effective if the control location is parameterized to be selected from the fieldbus.
6	RUN_DISABLE	1	Run disable. If the drive is set to receive the run enable signal from the fieldbus, this bit deactivates the signal.
		0	Run enable. If the drive is set to receive the run enable signal from the fieldbus, this bit activates the signal.
7	STOPMODE_RAMP	1	Normal ramp stop mode
		0	(no op) Default to parameter stop mode if bits 7...9 are all 0.
8	STOPMODE_EMERGENCY_RAMP	1	Emergency ramp stop mode.
		0	(no op) Default to parameter stop mode if bits 7...9 are all 0.
9	STOPMODE_COAST	1	Coast stop mode.
		0	(no op) Default to parameter stop mode if bits 7...9 are all 0.
10	RAMP_PAIR_2	1	Select ramp set 2 (Acceleration time 2 / Deceleration time 2) when parameter <a href="#">23.11 Ramp set selection</a> is set to <a href="#">EFB DCU CW bit 10</a> .
		0	Select ramp set 1 (Acceleration time 1 / Deceleration time 1) when parameter <a href="#">23.11 Ramp set selection</a> is set to <a href="#">EFB DCU CW bit 10</a> .
11	RAMP_OUT_ZERO	1	Force Ramp Function Generator output to zero. Drive ramps to stop (current and DC voltage limits in force).
		0	Normal operation.
12	RAMP_HOLD	1	Halt ramping (Ramp Function Generator output held).
		0	Normal operation.
13	RAMP_IN_ZERO	1	Force Ramp Function Generator input to zero.
		0	Normal operation.
14	REQ_LOCAL_LOCK	1	Drive does not switch to local control mode (see parameter <a href="#">19.17 Local control disable</a> ).
		0	Drive can switch between local and remote control modes.

Bit	Name	Value	State/Description
15	TORQ_LIM_PAIR_2	1	Select torque limit set 2 (Minimum torque 2 / Maximum torque 2) when parameter <a href="#">30.18 Torq lim sel</a> is set to <a href="#">EFB</a> .
		0	Select torque limit set 1 (Minimum torque 1 / Maximum torque 1) when parameter <a href="#">30.18 Torq lim sel</a> is set to <a href="#">EFB</a> .
16	FB_LOCAL_CTL	1	Local mode for control from the fieldbus is requested. Steal control from the active source.
		0	(no op)
17	FB_LOCAL_REF	1	Local mode for reference from the fieldbus is requested. Steal reference from the active source.
		0	(no op)
18	Reserved for RUN_DISABLE_1		Not yet implemented.
19	Reserved		
20	Reserved		
21	Reserved		
22	USER_0		Writable control bits that can be combined with drive logic for application-specific functionality.
23	USER_1		
24	USER_2		
25	USER_3		
26... 31	Reserved		

## Status Word

### ■ Status Word for the ABB Drives profile

The table below shows the fieldbus Status Word for the ABB Drives control profile. The embedded fieldbus interface converts the drive Status Word into this form for the fieldbus. The upper case boldface text refers to the states shown in [State transition diagram for the ABB Drives profile](#) on page 522.

Bit	Name	Value	STATE/Description
0	RDY_ON	1	<b>READY TO SWITCH ON.</b>
		0	<b>NOT READY TO SWITCH ON.</b>
1	RDY_RUN	1	<b>READY TO OPERATE.</b>
		0	<b>OFF1 ACTIVE.</b>
2	RDY_REF	1	<b>OPERATION ENABLED.</b>
		0	<b>OPERATION INHIBITED.</b> See also parameter <a href="#">06.18 Start inhibit status word</a> (page 212).
3	TRIPPED	1	<b>FAULT.</b>
		0	No fault.
4	OFF_2_STATUS	1	OFF2 inactive.
		0	<b>OFF2 ACTIVE.</b>
5	OFF_3_STATUS	1	OFF3 inactive.
		0	<b>OFF3 ACTIVE.</b>
6	SWC_ON_INHIB	1	<b>SWITCH-ON INHIBITED.</b>
		0	–
7	ALARM	1	Warning/Alarm.
		0	No warning/alarm.
8	AT_SETPOINT	1	<b>OPERATING.</b> Actual value equals Reference (is within tolerance limits, for example, in speed control, speed error is 10% max. of nominal motor speed).
		0	Actual value differs from Reference (is outside tolerance limits).
9	REMOTE	1	Drive control location: REMOTE (EXT1 or EXT2).
		0	Drive control location: LOCAL.
10	ABOVE_LIMIT	1	Actual frequency or speed equals or exceeds supervision limit (set by drive parameter). Valid in both directions of rotation. Bit 10 of <a href="#">06.17 Drive status word 2</a> .
		0	Actual frequency or speed within supervision limit.

Bit	Name	Value	STATE/Description
11	USER_0		Status bits that can be combined with drive logic for application-specific functionality.
12	USER_1		
13	USER_2		
14	USER_3		
15	Reserved		

### ■ Status Word for the DCU Profile

The embedded fieldbus interface writes the drive Status Word bits 0 to 15 to the fieldbus Status Word as is. Bits 16 to 32 of the drive Status Word are not in use.

Bit	Name	Value	State/Description
0	READY	1	Drive is ready to receive the start command.
		0	Drive is not ready.
1	ENABLED	1	External run enable signal is active.
		0	External run enable signal is not active.
2	STARTED	1	Drive has received start command.
		0	Drive has not received start command.
3	RUNNING	1	Drive is modulating.
		0	Drive is not modulating.
4	ZERO_SPEED	1	Drive is at zero speed.
		0	Drive is not at zero speed.
5	ACCELERATING	1	Drive speed is increasing.
		0	Drive speed is not increasing.
6	DECELERATING	1	Drive speed is decreasing.
		0	Drive speed is not decreasing.
7	AT_SETPOINT	1	Drive is at setpoint.
		0	Drive is not at setpoint.
8	LIMIT	1	Drive operation is limited.
		0	Drive operation is not limited.
9	SUPERVISION	1	Actual value (speed, frequency or torque) is above a limit. Limit is set with parameters 46.31...46.33.
		0	Actual value (speed, frequency or torque) is within limits.
10	REVERSE_REF	1	Drive reference is in the reverse direction.
		0	Drive reference is in the forward direction
11	REVERSE_ACT	1	Drive is running in the reverse direction
		0	Drive is running in the forward direction



Bit	Name	Value	State/Description
12	PANEL_LOCAL	1	Control panel/keypad (or PC tool) is in local control mode.
		0	Control panel/keypad (or PC tool) is not in local control mode.
13	FIELDBUS_LOCAL	1	Fieldbus is in local control mode.
		0	Fieldbus is not in local control mode.
14	EXT2_ACT	1	External control location EXT2 is active.
		0	External control location EXT1 is active.
15	FAULT	1	Drive is faulted.
		0	Drive is not faulted.
16	ALARM	1	Warning/Alarm is active.
		0	No warning/alarm.
17	Reserved		
18	DIRLOCK	1	Direction lock is ON. (Direction change is locked out.)
		0	Direction lock is OFF.
19	LOCALLOCK	1	Local mode lock is ON. (Local mode is locked out.)
		0	Local mode lock is OFF.
20	CTL_MODE	1	Vector motor control mode is active.
		0	Scalar motor control mode is active.
21	Reserved		
22	USER_0		Status bits that can be combined with drive logic for application-specific functionality.
23	USER_1		
24	USER_2		
25	USER_3		
26	REQ_CTL	1	Control has been granted to this channel.
		0	Control has not been granted to this channel.
27	REQ_REF	1	Reference has been granted to this channel.
		0	Reference has not been granted to this channel.
28... 31	Reserved		

## State transition diagrams

### ■ State transition diagram for the ABB Drives profile

The diagram below shows the state transitions in the drive when the drive is using the ABB Drives profile and the drive is configured to follow the commands of the control word from the embedded fieldbus interface. The upper case texts refer to the states which are used in the tables representing the fieldbus Control and Status words. See sections [Control Word for the ABB Drives profile](#) on page 515 and [Status Word for the ABB Drives profile](#) on page 519.

---



Stop sequence:

- 477h = Stop according to [21.03 Stop mode](#)
- 47Eh = OFF1 ramp stop (Note: uninterruptable ramp stop)

Fault reset:

- Rising edge of MCW bit 7

Start after STO:

- If [31.22 STO indication run/stop](#) is not Fault/ Fault, check that [06.18 Start inhibit status word](#), bit 7 STO = 0 before giving a start command.

## References

### ■ References for the ABB Drives profile and DCU Profile

The ABB Drives profile supports the use of two references, EFB reference 1 and EFB reference 2. The references are 16-bit words each containing a sign bit and a 15-bit integer. A negative reference is formed by calculating the two's complement from the corresponding positive reference.

The references are scaled as defined by parameters [46.01...46.04](#); which scaling is in use depends on the setting of [58.26 EFB ref1 type](#) and [58.27 EFB ref2 type](#) (see page [397](#)).

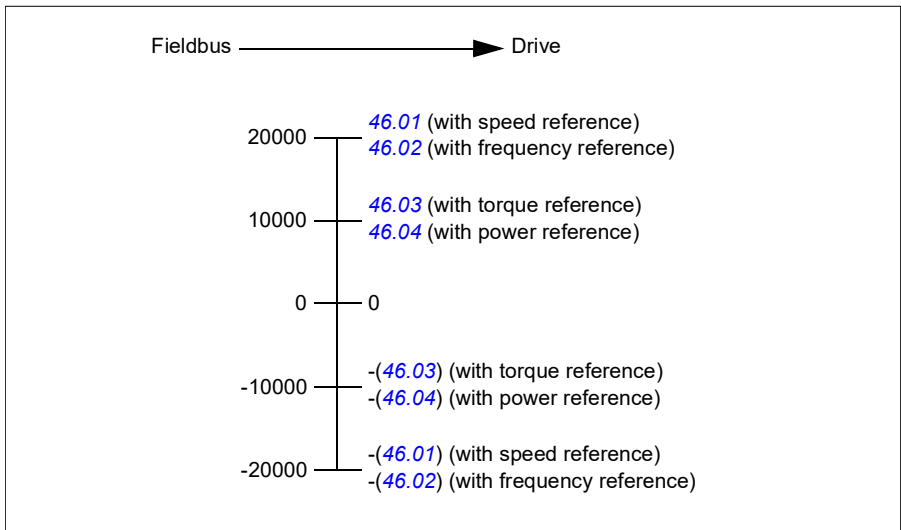

The scaled references are shown by parameters [03.09 EFB reference 1](#) and [03.10 EFB reference 2](#).

## Actual values

### Actual values for the ABB Drives profile and DCU Profile

The ABB Drives profile supports the use of two fieldbus actual values, ACT1 and ACT2. The actual values are 16-bit words each containing a sign bit and a 15-bit integer. A negative value is formed by calculating the two's complement from the corresponding positive value.

The actual values are scaled as defined by parameters [46.01...46.04](#); which scaling is in use depends on the setting of parameters [58.28 EFB act1 type](#) and [58.29 EFB act2 type](#) (see page [397](#)).

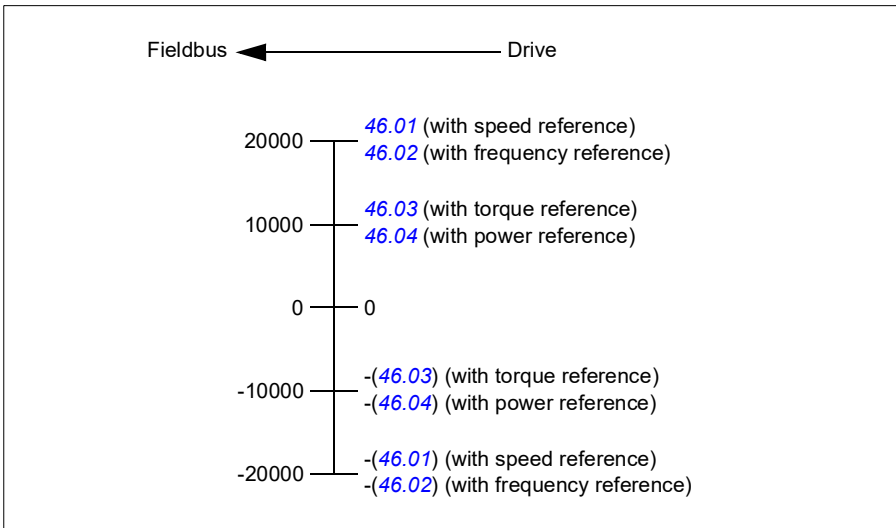

## Modbus holding register addresses

### ■ Modbus holding register addresses for the ABB Drives profile and DCU Profile

The table below shows the default Modbus holding register addresses for the drive data with the ABB Drives profile. This profile provides a converted 16-bit access to the drive data.

**Note:** Only the 16 least significant bits of the drive's 32-bit Control and Status Words can be accessed.

**Note:** Bits 16 through 32 of the DCU Control/Status word are not in use if 16-bit control/status word is used with the DCU Profile.

Register address	Register data (16-bit words)
400001	Default: Control word ( <i>CW 16bit</i> ). See sections <i>Control Word for the ABB Drives profile</i> (page 515) and <i>Control Word for the DCU Profile</i> (page 516). The selection can be changed using parameter <i>58.101 Data I/O 1</i> .
400002	Default: Reference 1 ( <i>Ref1 16bit</i> ). The selection can be changed using parameter <i>58.102 Data I/O 2</i> .
400003	Default: Reference 2 ( <i>Ref2 16bit</i> ). The selection can be changed using parameter <i>58.102 Data I/O 2</i> .
400004	Default: Status Word ( <i>SW 16bit</i> ). See sections <i>Status Word for the ABB Drives profile</i> (page 519) and <i>Status Word for the DCU Profile</i> (page 520). The selection can be changed using parameter <i>58.102 Data I/O 2</i> .
400005	Default: Actual value 1 ( <i>Act1 16bit</i> ). The selection can be changed using parameter <i>58.105 Data I/O 5</i> .
400006	Actual value 2 ( <i>Act2 16bit</i> ). The selection can be changed using parameter <i>58.106 Data I/O 6</i> .
400007...400014	Data in/out 7...14. Selected by parameters <i>58.107 Data I/O 7 ...58.114 Data I/O 14</i> .
400015...400089	Unused
400090...400100	Error code access. See section <i>Error code registers (holding registers 400090...400100)</i> (page 534).
400101...465536	Parameter read/write. Parameters are mapped to register addresses according to parameter <i>58.33 Addressing mode</i> .

## Modbus function codes

The table below shows the Modbus function codes supported by the embedded fieldbus interface.

Code	Function name	Description
01h	Read Coils	Reads the 0/1 status of coils (0X references).
02h	Read Discrete Inputs	Reads the 0/1 status of discrete inputs (1X references).
03h	Read Holding Registers	Reads the binary contents of holding registers (4X references).
05h	Write Single Coil	Forces a single coil (0X reference) to 0 or 1.
06h	Write Single Register	Writes a single holding register (4X reference).
08h	Diagnostics	Provides a series of tests for checking the communication, or for checking various internal error conditions. Supported subcodes: <ul style="list-style-type: none"> <li>• 00h Return Query Data: Echo/loopback test.</li> <li>• 01h Restart Comm Option: Restarts and initializes the EFB, clears communications event counters.</li> <li>• 04h Force Listen Only Mode</li> <li>• 0Ah Clear Counters and Diagnostic Register</li> <li>• 0Bh Return Bus Message Count</li> <li>• 0Ch Return Bus Comm. Error Count</li> <li>• 0Dh Return Bus Exception Error Count</li> <li>• 0Eh Return Slave Message Count</li> <li>• 0Fh Return Slave No Response Count</li> <li>• 10h Return Slave NAK (negative acknowledge) Count</li> <li>• 11h Return Slave Busy Count</li> <li>• 12h Return Bus Character Overrun Count</li> <li>• 14h Clear Overrun Counter and Flag</li> </ul>
0Bh	Get Comm Event Counter	Returns a status word and an event count.
0Fh	Write Multiple Coils	Forces a sequence of coils (0X references) to 0 or 1.
10h	Write Multiple Registers	Writes the contents of a contiguous block of holding registers (4X references).
16h	Mask Write Register	Modifies the contents of a 4X register using a combination of an AND mask, an OR mask, and the register's current contents.
17h	Read/Write Multiple Registers	Writes the contents of a contiguous block of 4X registers, then reads the contents of another group of registers (the same or different than those written) in a server device.



Code	Function name	Description
2Bh / 0Eh	Encapsulated Interface Transport	<p>Supported subcodes:</p> <ul style="list-style-type: none"> <li>• 0Eh Read Device Identification: Allows reading the identification and other information.</li> </ul> <p>Supported ID codes (access type):</p> <ul style="list-style-type: none"> <li>• 00h: Request to get the basic device identification (stream access)</li> <li>• 04h: Request to get one specific identification object (individual access)</li> </ul> <p>Supported Object IDs:</p> <ul style="list-style-type: none"> <li>• 00h: Vendor Name (“ABB”)</li> <li>• 01h: Product Code (for example, “ASCD2” or “ASCD4”)</li> <li>• 02h: Major Minor Revision (combination of contents of parameters <a href="#">07.05 Firmware version</a> and <a href="#">58.02 Protocol ID</a>).</li> <li>• 03h: Vendor URL (“www.abb.com”)</li> <li>• 04h: Product name: (“ACS580”).</li> </ul>

## Exception codes

The table below shows the Modbus exception codes supported by the embedded fieldbus interface.

Code	Name	Description
01h	ILLEGAL FUNCTION	The function code received in the query is not an allowable action for the server.
02h	ILLEGAL ADDRESS	The data address received in the query is not an allowable address for the server.
03h	ILLEGAL VALUE	The requested quantity of registers is larger than the device can handle. This error does not mean that a value written to the device is outside of the valid range.
04h	DEVICE FAILURE	An unrecoverable error occurred while the server was attempting to perform the requested action. See section <a href="#">Error code registers (holding registers 400090...400100)</a> on page 534.

## Coils (0xxxx reference set)

Coils are 1-bit read/write values. Control Word bits are exposed with this data type. The table below summarizes the Modbus coils (0xxxx reference set). Note that the references are 1-based index which match the address transmitted on the wire.

Reference	ABB Drives profile	DCU Profile
000001	OFF1_CONTROL	STOP
000002	OFF2_CONTROL	START
000003	OFF3_CONTROL	Reserved
000004	INHIBIT_OPERATION	Reserved
000005	RAMP_OUT_ZERO	RESET
000006	RAMP_HOLD	EXT2
000007	RAMP_IN_ZERO	RUN_DISABLE
000008	RESET	STOPMODE_RAMP
000009	JOGGING_1	STOPMODE_EMERGENCY_RAMP
000010	JOGGING_2	STOPMODE_COAST
000011	REMOTE_CMD	Reserved
000012	EXT_CTRL_LOC	RAMP_OUT_ZERO
000013	USER_0	RAMP_HOLD
000014	USER_1	RAMP_IN_ZERO
000015	USER_2	Reserved
000016	USER_3	Reserved
000017	Reserved	FB_LOCAL_CTL
000018	Reserved	FB_LOCAL_REF
000019	Reserved	Reserved
000020	Reserved	Reserved
000021	Reserved	Reserved
000022	Reserved	Reserved
000023	Reserved	USER_0
000024	Reserved	USER_1
000025	Reserved	USER_2
000026	Reserved	USER_3
000027	Reserved	Reserved
000028	Reserved	Reserved
000029	Reserved	Reserved
000030	Reserved	Reserved
000031	Reserved	Reserved
000032	Reserved	Reserved

---

Reference	ABB Drives profile	DCU Profile
000033	Control for relay output RO1 (parameter <i>10.99 RO/DIO control word</i> , bit 0)	Control for relay output RO1 (parameter <i>10.99 RO/DIO control word</i> , bit 0)
000034	Control for relay output RO2 (parameter <i>10.99 RO/DIO control word</i> , bit 1)	Control for relay output RO2 (parameter <i>10.99 RO/DIO control word</i> , bit 1)
000035	Control for relay output RO3 (parameter <i>10.99 RO/DIO control word</i> , bit 2)	Control for relay output RO3 (parameter <i>10.99 RO/DIO control word</i> , bit 2)
000036	Control for relay output RO4 (parameter <i>10.99 RO/DIO control word</i> , bit 3)	Control for relay output RO4 (parameter <i>10.99 RO/DIO control word</i> , bit 3)
000037	Control for relay output RO5 (parameter <i>10.99 RO/DIO control word</i> , bit 4)	Control for relay output RO5 (parameter <i>10.99 RO/DIO control word</i> , bit 4)

## Discrete inputs (1xxxx reference set)

Discrete inputs are 1-bit read-only values. Status Word bits are exposed with this data type. The table below summarizes the Modbus discrete inputs (1xxxx reference set). Note that the references are 1-based index which match the address transmitted on the wire.

Reference	ABB Drives profile	DCU Profile
100001	RDY_ON	READY
100002	RDY_RUN	D
100003	RDY_REF	Reserved
100004	TRIPPED	RUNNING
100005	OFF_2_STATUS	ZERO_SPEED
100006	OFF_3_STATUS	Reserved
100007	SWC_ON_INHIB	Reserved
100008	ALARM	AT_SETPOINT
100009	AT_SETPOINT	LIMIT
100010	REMOTE	SUPERVISION
100011	ABOVE_LIMIT	Reserved
100012	USER_0	Reserved
100013	USER_1	PANEL_LOCAL
100014	USER_2	FIELDBUS_LOCAL
100015	USER_3	EXT2_ACT
100016	Reserved	FAULT
100017	Reserved	ALARM
100018	Reserved	Reserved
100019	Reserved	Reserved
100020	Reserved	Reserved
100021	Reserved	CTL_MODE
100022	Reserved	Reserved
100023	Reserved	USER_0
100024	Reserved	USER_1
100025	Reserved	USER_2
100026	Reserved	USER_3
100027	Reserved	REQ_CTL
100028	Reserved	Reserved
100029	Reserved	Reserved
100030	Reserved	Reserved
100031	Reserved	Reserved
100032	Reserved	Reserved

---

Reference	ABB Drives profile	DCU Profile
100033	Delayed status of digital input DI1 (parameter <a href="#">10.02 DI delayed status</a> , bit 0)	Delayed status of digital input DI1 (parameter <a href="#">10.02 DI delayed status</a> , bit 0)
100034	Delayed status of digital input DI2 (parameter <a href="#">10.02 DI delayed status</a> , bit 1)	Delayed status of digital input DI2 (parameter <a href="#">10.02 DI delayed status</a> , bit 1)
100035	Delayed status of digital input DI3 (parameter <a href="#">10.02 DI delayed status</a> , bit 2)	Delayed status of digital input DI3 (parameter <a href="#">10.02 DI delayed status</a> , bit 2)
100036	Delayed status of digital input DI4 (parameter <a href="#">10.02 DI delayed status</a> , bit 3)	Delayed status of digital input DI4 (parameter <a href="#">10.02 DI delayed status</a> , bit 3)
100037	Delayed status of digital input DI5 (parameter <a href="#">10.02 DI delayed status</a> , bit 4)	Delayed status of digital input DI5 (parameter <a href="#">10.02 DI delayed status</a> , bit 4)
100038	Delayed status of digital input DI6 (parameter <a href="#">10.02 DI delayed status</a> , bit 5)	Delayed status of digital input DI6 (parameter <a href="#">10.02 DI delayed status</a> , bit 5)

**Error code registers (holding registers 400090...400100)**

These registers contain information about the last query. The error register is cleared when a query has finished successfully.

Reference	Name	Description
400090	Reset Error Registers	1 = Reset internal error registers (91...95). 0 = Do nothing.
400091	Error Function Code	Function code of the failed query.
400092	Error Code	Set when exception code 04h is generated (see table above). <ul style="list-style-type: none"> <li>• 00h No error</li> <li>• 02h Low/High limit exceeded</li> <li>• 03h Faulty Index: Unavailable index of an array parameter</li> <li>• 05h Incorrect Data Type: Value does not match the data type of the parameter</li> <li>• 65h General Error: Undefined error when handling query</li> </ul>
400093	Failed Register	The last register (discrete input, coil, input register or holding register) that failed to be read or written.
400094	Last Register Written Successfully	The last register (discrete input, coil, input register or holding register) that was written successfully.
400095	Last Register Read Successfully	The last register (discrete input, coil, input register or holding register) that was read successfully.



# Fieldbus control through a fieldbus adapter

---

## What this chapter contains

This chapter describes how the drive can be controlled by external devices over a communication network (fieldbus) through an optional fieldbus adapter module.

The fieldbus control interface of the drive is described first, followed by a configuration example.

## System overview

The drive can be connected to an external control system through an optional fieldbus adapter (“fieldbus adapter A” = FBA A) mounted onto the control unit of the drive. The drive can be configured to receive all of its control information through the fieldbus interface, or the control can be distributed between the fieldbus interface and other available sources such as digital and analog inputs, depending on how control locations EXT1 and EXT2 are configured.

---

Fieldbus adapters are available for various communication systems and protocols, for example

- CANopen (FCAN-01 adapter)
- ControlNet (FCNA-01 adapter)
- DeviceNet™ (FDNA-01 adapter)
- Ethernet POWERLINK (FEPL-02 adapter)
- EtherCAT (FECA-01 adapter)
- EtherNet/IP™ (FENA-21 adapter)
- Modbus/RTU (FSCA-01 adapter)
- Modbus/TCP (FMBT-21, FENA-21 adapter)
- PROFINET IO (FENA-21 adapter)
- PROFIBUS DP (FPBA-01 adapter)

**Note:** The text and examples in this chapter describe the configuration of one fieldbus adapter (FBA A) by parameters [50.01...50.18](#) and parameter groups [51 FBA A settings...53 FBA A data out](#).

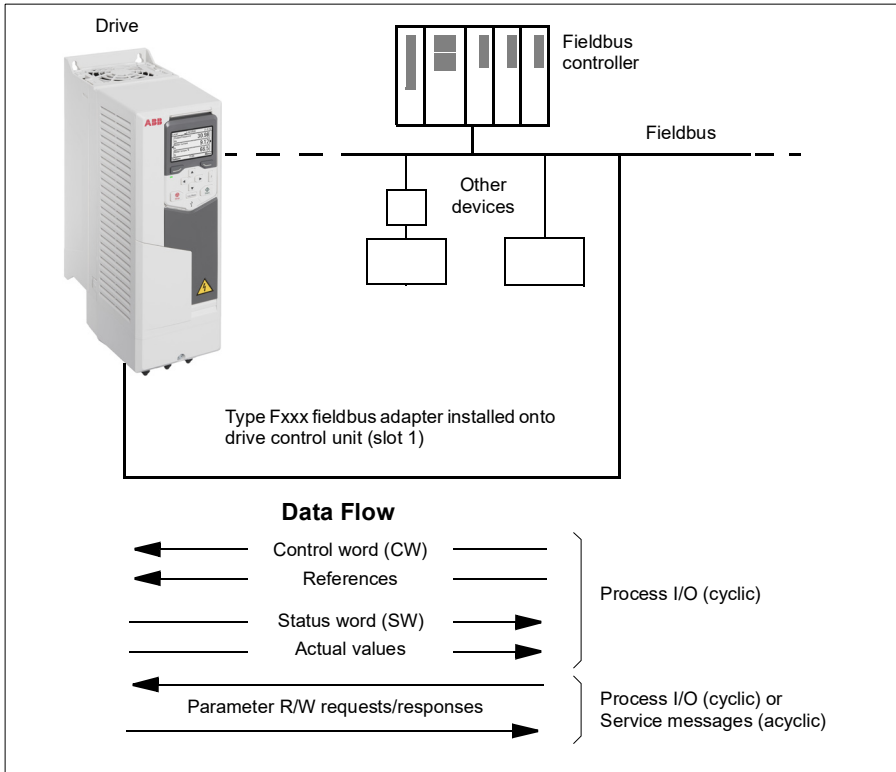



## Basics of the fieldbus control interface

The cyclic communication between a fieldbus system and the drive consists of 16- or 32-bit input and output data words. The drive is able to support a maximum of 12 data words (16 bits) in each direction.

Data transmitted from the drive to the fieldbus controller is defined by parameters [52.01 FBA A data in1](#) ... [52.12 FBA A data in12](#). The data transmitted from the fieldbus controller to the drive is defined by parameters [53.01 FBA A data out1](#) ... [53.12 FBA A data out12](#).

Fieldbus network

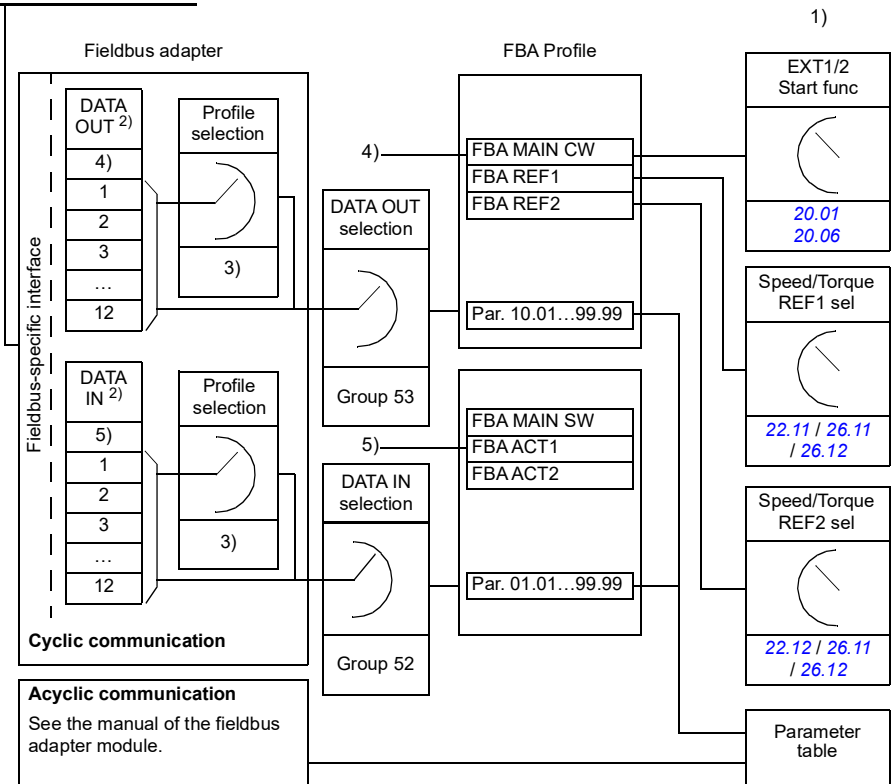

- 1) See also other parameters which can be controlled from fieldbus.
- 2) The maximum number of data words used is protocol-dependent.
- 3) Profile/instance selection parameters. Fieldbus module specific parameters. For more information, see the *User's manual* of the appropriate fieldbus adapter module.
- 4) With DeviceNet, the control part is transmitted directly.
- 5) With DeviceNet, the actual value part is transmitted directly.

## ■ **Control word and Status word**

The Control word is the principal means for controlling the drive from a fieldbus system. It is sent by the fieldbus master station to the drive through the adapter module. The drive switches between its states according to the bit-coded instructions in the Control word, and returns status information to the master in the Status word.

For the ABB Drives communication profile, the contents of the Control word and the Status word are detailed on pages [541](#) and [543](#) respectively. The drive states are presented in the state diagram (page [544](#)). For other fieldbus-specific communication profiles, see the manual of the fieldbus adapter.

The contents of the Control word and the Status word are detailed on pages [541](#) and [543](#) respectively. The drive states are presented in the state diagram (page [544](#)).

### **Debugging the network words**

If parameter [50.12 FBA A debug mode](#) is set to *Fast*, the Control word received from the fieldbus is shown by parameter [50.13 FBA A control word](#), and the Status word transmitted to the fieldbus network by [50.16 FBA A status word](#). This "raw" data is very useful to determine if the fieldbus master is transmitting the correct data before handing control to the fieldbus network.

---

## References

References are 16-bit words containing a sign bit and a 15-bit integer. A negative reference (indicating reversed direction of rotation) is formed by calculating the two's complement from the corresponding positive reference.

ABB drives can receive control information from multiple sources including analog and digital inputs, the drive control panel and a fieldbus adapter module. In order to have the drive controlled through the fieldbus, the module must be defined as the source for control information such as reference. This is done using the source selection parameters in groups [22 Speed reference selection](#), [26 Torque reference chain](#) and [28 Frequency reference chain](#).

### Debugging the network words

If parameter [50.12 FBA A debug mode](#) is set to *Fast*, the references received from the fieldbus are displayed by [50.14 FBA A reference 1](#) and [50.15 FBA A reference 2](#).

### Scaling of references

**Note:** The scalings described below are for the ABB Drives communication profile. Fieldbus-specific communication profiles may use different scalings. For more information, see the manual of the fieldbus adapter.

The references are scaled as defined by parameters [46.01...46.04](#); which scaling is in use depends on the setting of [50.04 FBA A ref1 type](#) and [50.05 FBA A ref2 type](#).

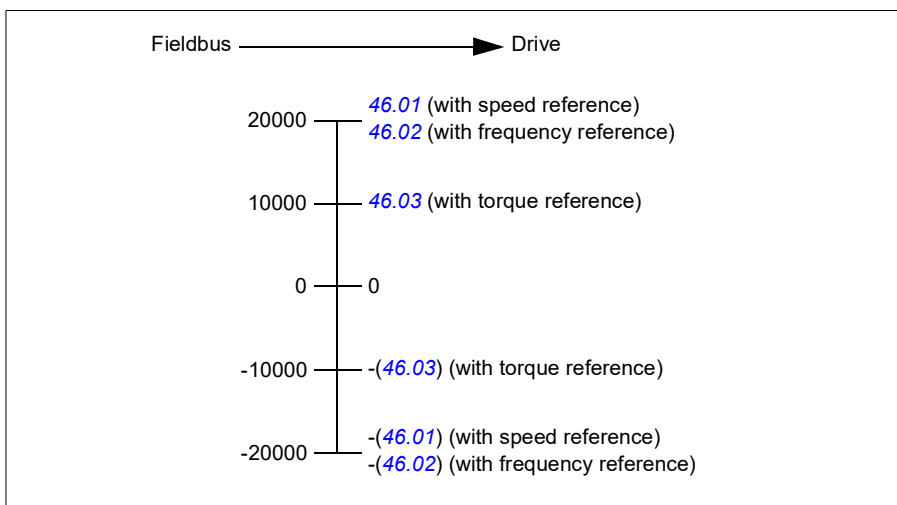

The scaled references are shown by parameters [03.05 FB A reference 1](#) and [03.06 FB A reference 2](#).

## ■ Actual values

Actual values are 16-bit words containing information on the operation of the drive. The types of the monitored signals are selected by parameters [50.07 FBA A actual 1 type](#) and [50.08 FBA A actual 2 type](#).

### Debugging the network words

If parameter [50.12 FBA A debug mode](#) is set to *Fast*, the actual values sent to the fieldbus are displayed by [50.17 FBA A actual value 1](#) and [50.18 FBA A actual value 2](#).

### Scaling of actual values

**Note:** The scalings described below are for the ABB Drives communication profile. Fieldbus-specific communication profiles may use different scalings. For more information, see the manual of the fieldbus adapter.

The actual values are scaled as defined by parameters [46.01...46.04](#); which scaling is in use depends on the setting of parameters [50.07 FBA A actual 1 type](#) and [50.08 FBA A actual 2 type](#).

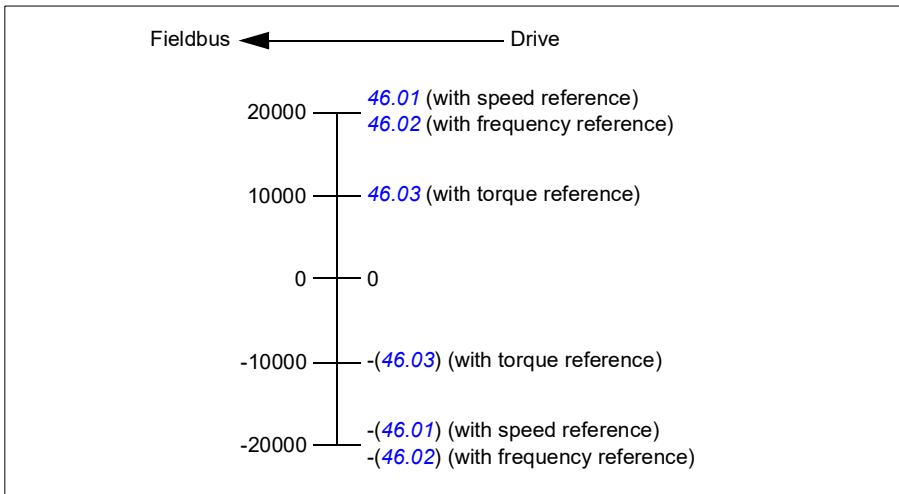

## ■ Contents of the fieldbus Control word (ABB Drives profile)

The upper case boldface text refers to the states shown in the state diagram (page 544).

Bit	Name	Value	STATE/Description
0	Off1 control	1	Proceed to <b>READY TO OPERATE</b> .
		0	Stop along currently active deceleration ramp. Proceed to <b>OFF1 ACTIVE</b> ; proceed to <b>READY TO SWITCH ON</b> unless other interlocks (OFF2, OFF3) are active.
1	Off2 control	1	Continue operation (OFF2 inactive).
		0	Emergency OFF, coast to a stop. Proceed to <b>OFF2 ACTIVE</b> , proceed to <b>SWITCH-ON INHIBITED</b> .
2	Off3 control	1	Continue operation (OFF3 inactive).
		0	Emergency stop, stop within time defined by drive parameter. Proceed to <b>OFF3 ACTIVE</b> ; proceed to <b>SWITCH-ON INHIBITED</b> .  <b>WARNING:</b> Ensure motor and driven machine can be stopped using this stop mode.
3	Run	1	Proceed to <b>OPERATION ENABLED</b> . <b>Note:</b> Run enable signal must be active; see the drive documentation. If the drive is set to receive the Run enable signal from the fieldbus, this bit activates the signal.
		0	Inhibit operation. Proceed to <b>OPERATION INHIBITED</b> . See also parameter <a href="#">06.18 Start inhibit status word</a> (page 212).
4	Ramp out zero	1	Normal operation. Proceed to <b>RAMP FUNCTION GENERATOR: OUTPUT ENABLED</b> .
		0	Force Ramp function generator output to zero. The drive will immediately decelerate to zero speed (observing the torque limits).
5	Ramp hold	1	ramp function. Proceed to <b>RAMP FUNCTION GENERATOR: ACCELERATOR ENABLED</b> .
		0	Halt ramping (Ramp Function Generator output held).
6	Ramp in zero	1	Normal operation. Proceed to <b>OPERATING</b> . <b>Note:</b> This bit is effective only if the fieldbus interface is set as the source for this signal by drive parameters.
		0	Force Ramp function generator input to zero.
7	Reset	0=>1	Fault reset if an active fault exists. Proceed to <b>SWITCH-ON INHIBITED</b> . <b>Note:</b> This bit is effective only if the fieldbus interface is set as the source of the reset signal by drive parameters.
		0	Continue normal operation.
8	Inching 1	1	Accelerate to inching (jogging) setpoint 1. <b>Notes:</b> <ul style="list-style-type: none"> <li>• Bits 4...6 must be 0.</li> <li>• See also section <a href="#">Rush control</a> (page 165).</li> </ul>
		0	Inching (jogging) 1 disabled.
9	Inching 2	1	Accelerate to inching (jogging) setpoint 2. See notes at bit 8.
		0	Inching (jogging) 2 disabled.
10	Remote cmd	1	Fieldbus control enabled.
		0	Control word and reference not getting through to the drive, except for bits 0...2.
11	Ext ctrl loc	1	Select External Control Location EXT2. Effective if control location is parameterized to be selected from fieldbus.
		0	Select External Control Location EXT1. Effective if control location is parameterized to be selected from fieldbus.

542 *Fieldbus control through a fieldbus adapter*

<b>Bit</b>	<b>Name</b>	<b>Value</b>	<b>STATE/Description</b>
12	User bit 0	1	
		0	
13	User bit 1	1	
		0	
14	User bit 2	1	
		0	
15	User bit 3	1	
		0	

## ■ Contents of the fieldbus Status word (ABB Drives profile)

The upper case boldface text refers to the states shown in the state diagram (page 544).

Bit	Name	Value	STATE/Description
0	Ready to switch ON	1	<b>READY TO SWITCH ON.</b>
		0	<b>NOT READY TO SWITCH ON.</b>
1	Ready run	1	<b>READY TO OPERATE.</b>
		0	<b>OFF1 ACTIVE.</b>
2	Ready ref	1	<b>OPERATION ENABLED.</b>
		0	<b>OPERATION INHIBITED.</b> See also parameter <a href="#">06.18 Start inhibit status word</a> (page 212).
3	Tripped	1	<b>FAULT.</b>
		0	No fault.
4	Off 2 inactive	1	OFF2 inactive.
		0	<b>OFF2 ACTIVE.</b>
5	Off 3 inactive	1	OFF3 inactive.
		0	<b>OFF3 ACTIVE.</b>
6	Switch-on inhibited	1	<b>SWITCH-ON INHIBITED.</b>
		0	-
7	Warning	1	Warning active.
		0	No warning active.
8	At setpoint	1	<b>OPERATING.</b> Actual value equals reference = is within tolerance limits (see parameters <a href="#">46.21...46.23</a> ).
		0	Actual value differs from reference = is outside tolerance limits.
9	Remote	1	Drive control location: REMOTE (EXT1 or EXT2).
		0	Drive control location: LOCAL.
10	Above limit	-	See bit 10 of <a href="#">06.17 Drive status word 2</a> .
11	User bit 0	-	See parameter <a href="#">06.30 MSW bit 11 selection</a> .
12	User bit 1	-	See parameter <a href="#">06.31 MSW bit 12 selection</a> .
13	User bit 2	-	See parameter <a href="#">06.32 MSW bit 13 selection</a> .
14	User bit 3	-	See parameter <a href="#">06.33 MSW bit 14 selection</a> .
15	Reserved		





## Setting up the drive for fieldbus control

1. Install the fieldbus adapter module mechanically and electrically according to the instructions given in the *User's manual* of the module.
  2. Power up the drive.
  3. Enable the communication between the drive and the fieldbus adapter module with parameter [50.01 FBA A enable](#).
  4. With [50.02 FBA A comm loss func](#), select how the drive should react to a fieldbus communication break.  
**Note:** This function monitors both the communication between the fieldbus master and the adapter module and the communication between the adapter module and the drive.
  5. With [50.03 FBA A comm loss t out](#), define the time between communication break detection and the selected action.
  6. Select application-specific values for the rest of the parameters in group [50 Fieldbus adapter \(FBA\)](#), starting from [50.04](#). Examples of appropriate values are shown in the tables below.
  7. Set the fieldbus adapter module configuration parameters in group [51 FBA A settings](#). As a minimum, set the required node address and the communication profile.
  8. Define the process data transferred to and from the drive in parameter groups [52 FBA A data in](#) and [53 FBA A data out](#).  
**Note:** Depending on the communication protocol and profile being used, the Control word and Status word may already be configured to be sent/received by the communication system.
  9. Save the valid parameter values to permanent memory by setting parameter [96.07 Parameter save manually](#) to [Save](#).
  10. Validate the settings made in parameter groups 51, 52 and 53 by setting parameter [51.27 FBA A par refresh](#) to [Configure](#).
  11. Configure control locations EXT1 and EXT2 to allow control and reference signals to come from the fieldbus. Examples of appropriate values are shown in the tables below.
-

## ■ Parameter setting example: FPBA (PROFIBUS DP) with ABB Drives profile

This example shows how to configure a basic speed control application that uses the ABB Drives communication profile with PPO Type 2. The start/stop commands and reference are according to the ABB Drives profile, speed control mode.

The reference values sent over the fieldbus have to be scaled within the drive so they have the desired effect. The reference value  $\pm 16384$  (4000h) corresponds to the range of speed set in parameter [46.01 Speed scaling](#) (both forward and reverse directions). For example, if [46.01](#) is set to 480 rpm, then 4000h sent over fieldbus will request 480 rpm.

Direction	PZD1	PZD2	PZD3	PZD4	PZD5	PZD6
Out	Control word	Speed reference	Acc time 1		Dec time 1	
In	Status word	Speed actual value	Motor current		DC voltage	

The table below gives the recommended drive parameter settings.

Drive parameter	Setting for ACX580 drives	Description
<a href="#">50.01 FBA A enable</a>	1 = [slot number]	s communication between the drive and the fieldbus adapter module.
<a href="#">50.04 FBA A ref1 type</a>	4 = <i>Speed</i>	Selects the fieldbus A reference 1 type and scaling.
<a href="#">50.07 FBA A actual 1 type</a>	0 = <i>Speed or frequency</i>	Selects the actual value type and scaling according to the currently active Ref1 mode defined in parameter <a href="#">50.04</a> .
<a href="#">51.01 FBA A type</a>	1 = FPBA <sup>1)</sup>	Displays the type of the fieldbus adapter module.
51.02 Node address	3 <sup>2)</sup>	Defines the PROFIBUS node address of the fieldbus adapter module.
51.03 Baud rate	12000 <sup>1)</sup>	Displays the current baud rate on the PROFIBUS network in kbit/s.
51.04 MSG type	1 = PPO2 <sup>1)</sup>	Displays the telegram type selected by the PLC configuration tool.
51.05 Profile	1 = ABB Drives	Selects the Control word according to the ABB Drives profile (speed control mode).
51.07 RPBA mode	0 = Disabled	Disables the RPBA emulation mode.
52.01 FBA data in1	4 = SW 16bit <sup>1)</sup>	Status word
52.02 FBA data in2	5 = Act1 16bit	Actual value 1
52.03 FBA data in3	01.07 <sup>2)</sup>	Motor current
52.05 FBA data in5	01.11 <sup>2)</sup>	DC voltage
53.01 FBA data out1	1 = CW 16bit <sup>1)</sup>	Control word
53.02 FBA data out2	2 = Ref1 16bit	Reference 1 (speed)

Drive parameter	Setting for ACX580 drives	Description
53.03 FBA data out3	23.12 <sup>2)</sup>	Acceleration time 1
53.05 FBA data out5	23.13 <sup>2)</sup>	Deceleration time 1
<a href="#">51.27 FBA A par refresh</a>	<b>1 = Configure</b>	Validates the configuration parameter settings.
<a href="#">19.12 Ext1 control mode</a>	<b>2 = Speed</b>	Selects speed control as the control mode 1 for external control location EXT1.
<a href="#">20.01 Ext1 commands</a>	<b>12 = Fieldbus A</b>	Selects fieldbus adapter A as the source of the start and stop commands for external control location EXT1.
<a href="#">20.02 Ext1 start trigger type</a>	<b>1 = Level</b>	Selects a level-triggered start signal for external control location EXT1.
<a href="#">22.11 Ext1 speed ref1</a>	<b>4 = FB A ref1</b>	Selects fieldbus A reference 1 as the source for speed reference 1.

<sup>1)</sup> Read-only or automatically detected/set

<sup>2)</sup> Example

Control word:

- 477h (1143 decimal) → READY TO SWITCH ON
- 47Fh (1151 decimal) → OPERATING (Speed mode)

Start sequence:

- 476h → NOT READY TO SWITCH ON
- If MSW bit 0 = 1 then
  - 477h → READY TO SWITCH ON (Stopped)
  - 47Fh → OPERATION (Running)

Stop sequence:

- 477h = Stop according to [21.03 Stop mode](#)
- 47Eh = OFF1 ramp stop (Note: uninterruptable ramp stop)

Fault reset:

- Rising edge of MCW bit 7

Start after STO:

If [31.22 STO indication run/stop](#) is not Fault/ Fault, check that [06.18 Start inhibit status word](#), bit 7 STO = 0 before giving a start command.

## Automatic drive configuration for fieldbus control

The parameters set on module detection are shown in the table below. See also parameters [07.35 Drive configuration](#) and [07.36 Drive configuration 2](#).

Option	50.01 FBA A enable	50.02 FBA A comm loss func	51.02 FBA A Par2	51.04 FBA A Par4	51.05 FBA A Par5	51.06 FBA A Par6
FENA-21	1 (Enable)	0 (No action)	11	0	-	-
FECA-01	1 (Enable)	0 (No action)	0	-	-	-
FPBA-01	1 (Enable)	0 (No action)	-	-	1	-
FCAN-01	1 (Enable)	0 (No action)	-	-	0	-
FSCA-01	1 (Enable)	0 (No action)	-	-	-	10
FEIP-21	1 (Enable)	0 (No action)	100	0	-	-
FMBT-21	1 (Enable)	0 (No action)	0	0	-	-
FPNO-21	1 (Enable)	0 (No action)	11	0	-	-
FEPL-02	1 (Enable)	0 (No action)	-	-	-	-
FDNA-01	1 (Enable)	0 (No action)	-	-	-	-
FCNA-01	1 (Enable)	0 (No action)	-	-	-	-

Option	51.07 FBA A Par7	51.21 FBA A Par21	51.23 FBA A Par23	51.24 FBA A Par24	52.01 FBA data in1	52.02 FBA data in2
FENA-21	-	-	-	-	4	5
FECA-01	-	-	-	-	-	-
FPBA-01	-	-	-	-	4	5
FCAN-01	-	-	-	-	-	-
FSCA-01	1	-	-	-	-	-
FEIP-21	-	-	128	128	-	-
FMBT-21	-	1	-	-	-	-
FBIP-21	-	-	-	-	-	-
FPNO-21	-	-	-	-	4	5
FEPL-02	-	-	-	-	-	-
FDNA-01	-	-	-	-	-	-
FCNA-01	-	-	-	-	-	-

Option	53.01 FBA data out1	53.02 FBA data out2
FENA-21	1	2
FECA-01	-	-
FPBA-01	1	2
FCAN-01	-	-
FSCA-01		
FEIP-21	-	-
FMBT-21	-	-
FPNO-21	1	2
FEPL-02	-	-

<b>Option</b>	<b>53.01 FBA data out1</b>	<b>53.02 FBA data out2</b>
FDNA-01	-	-
FCNA-01	-	-



# 12

## Control chain diagrams

---

### Contents of this chapter

The chapter presents the reference chains of the drive. The control chain diagrams can be used to trace how parameters interact and where parameters have an effect within the drive parameter system.

For a more general diagram, see section [Operating modes of the drive](#) (page 112).

# Frequency reference selection

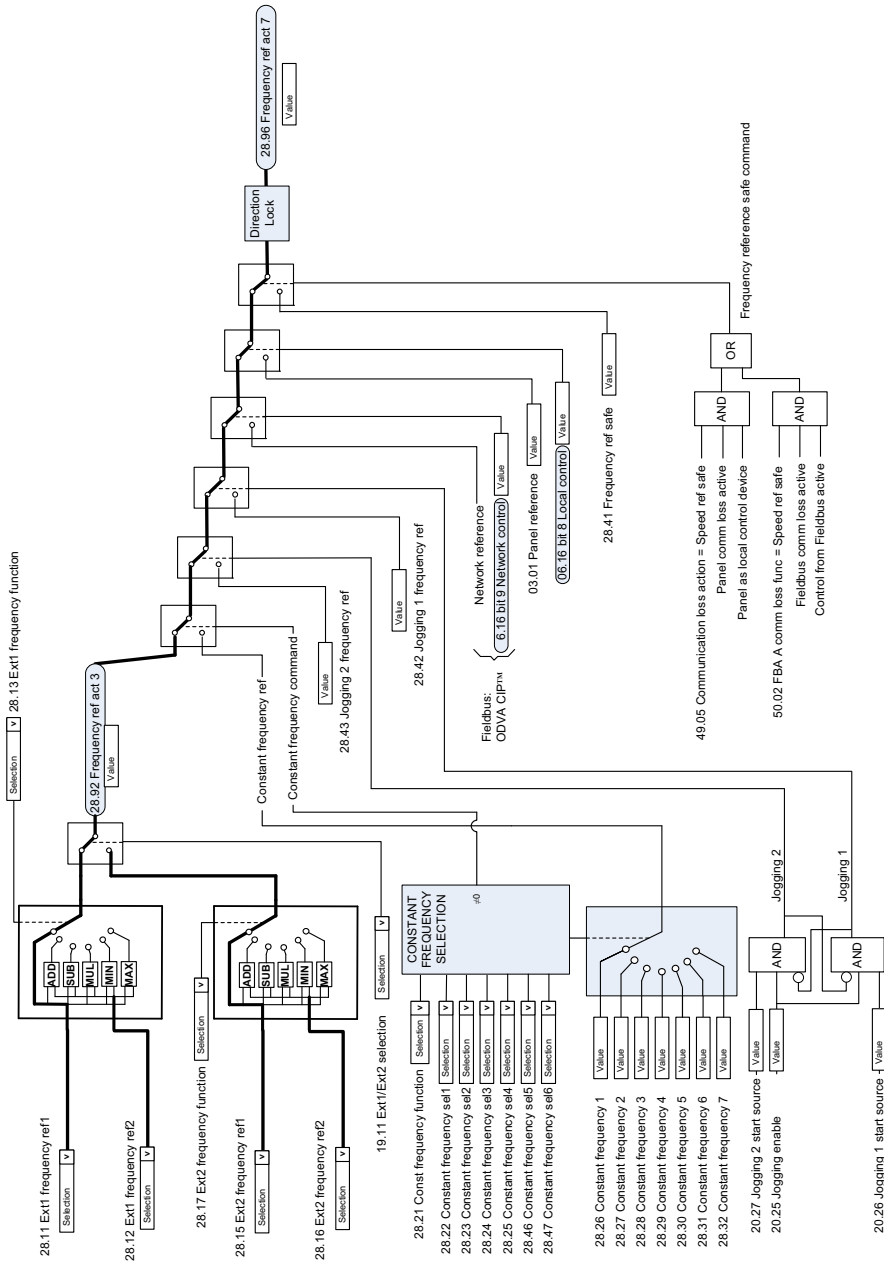



# Frequency reference modification

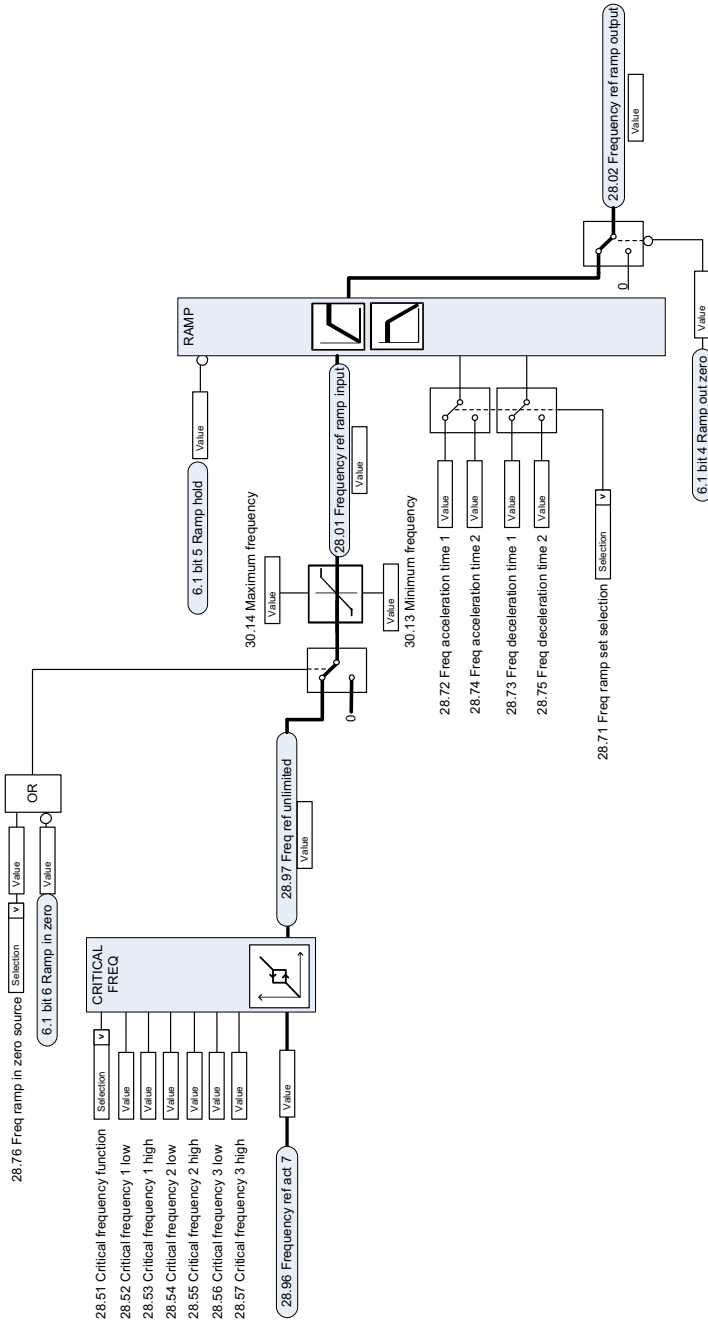

## Speed reference source selection I

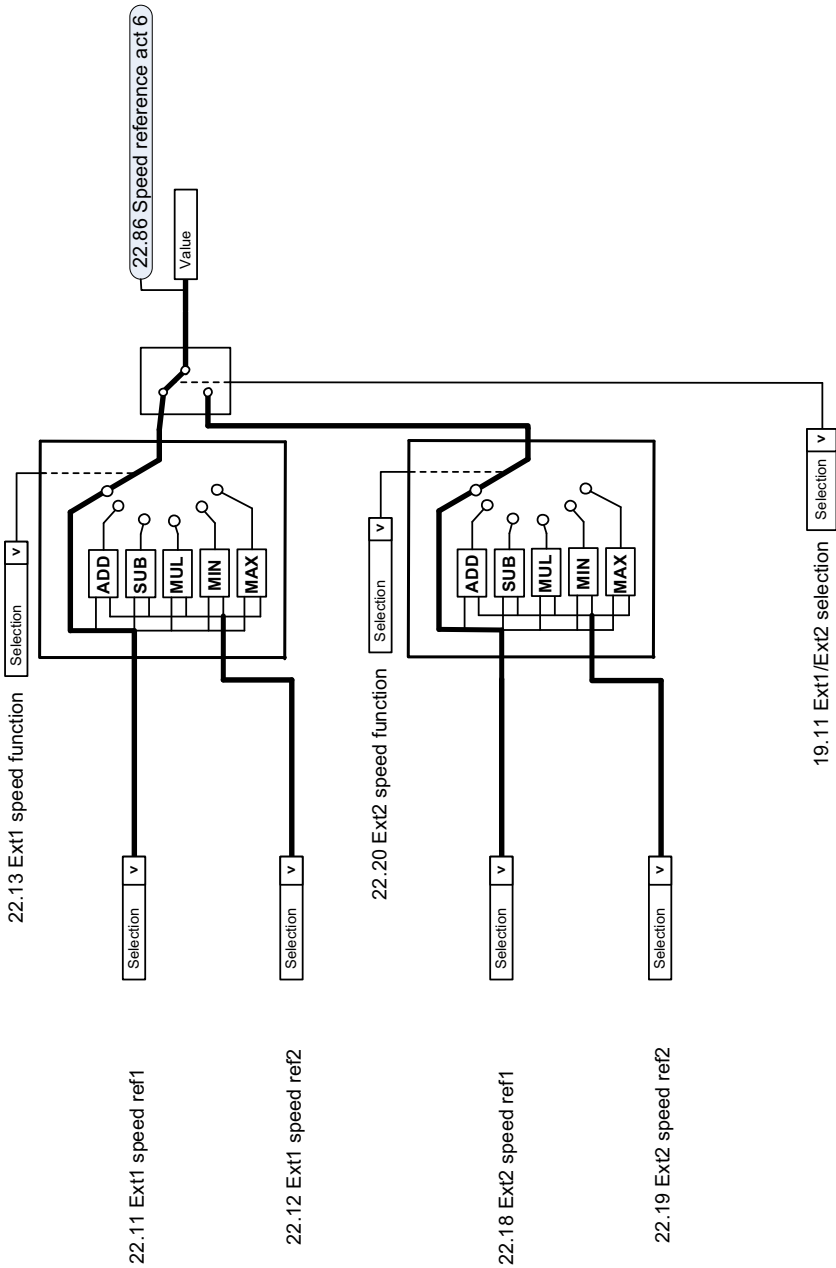

# Speed reference source selection II

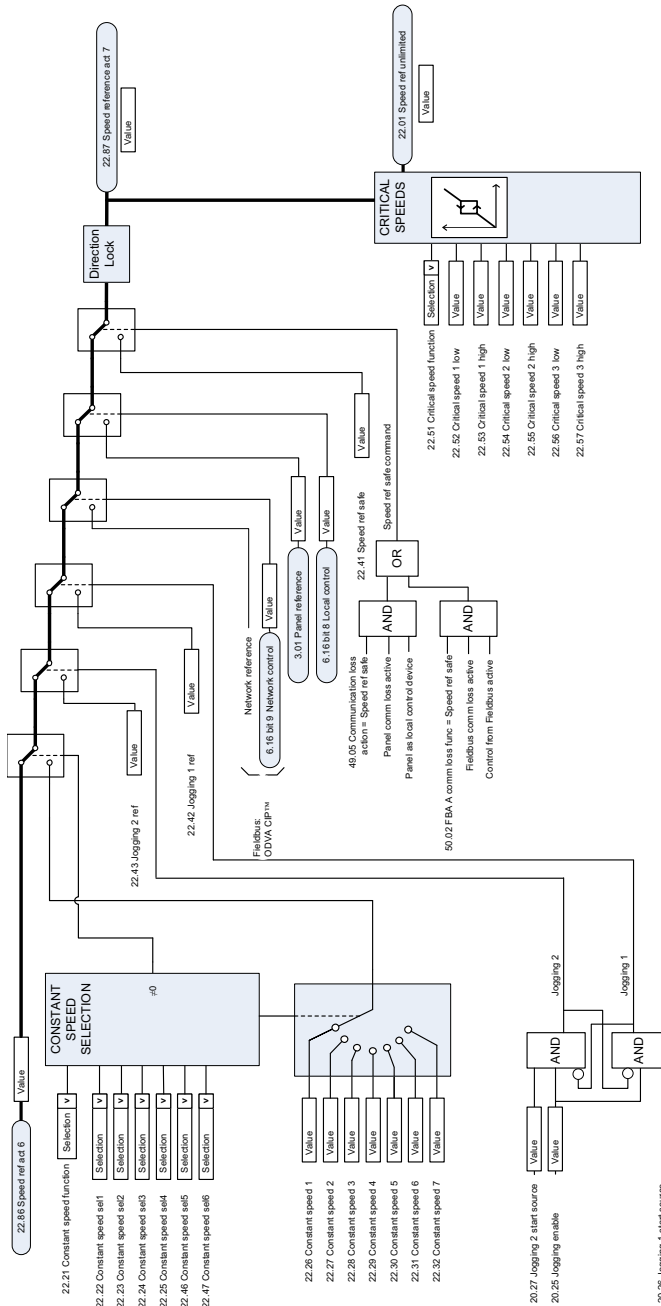

# Speed reference ramping and shaping

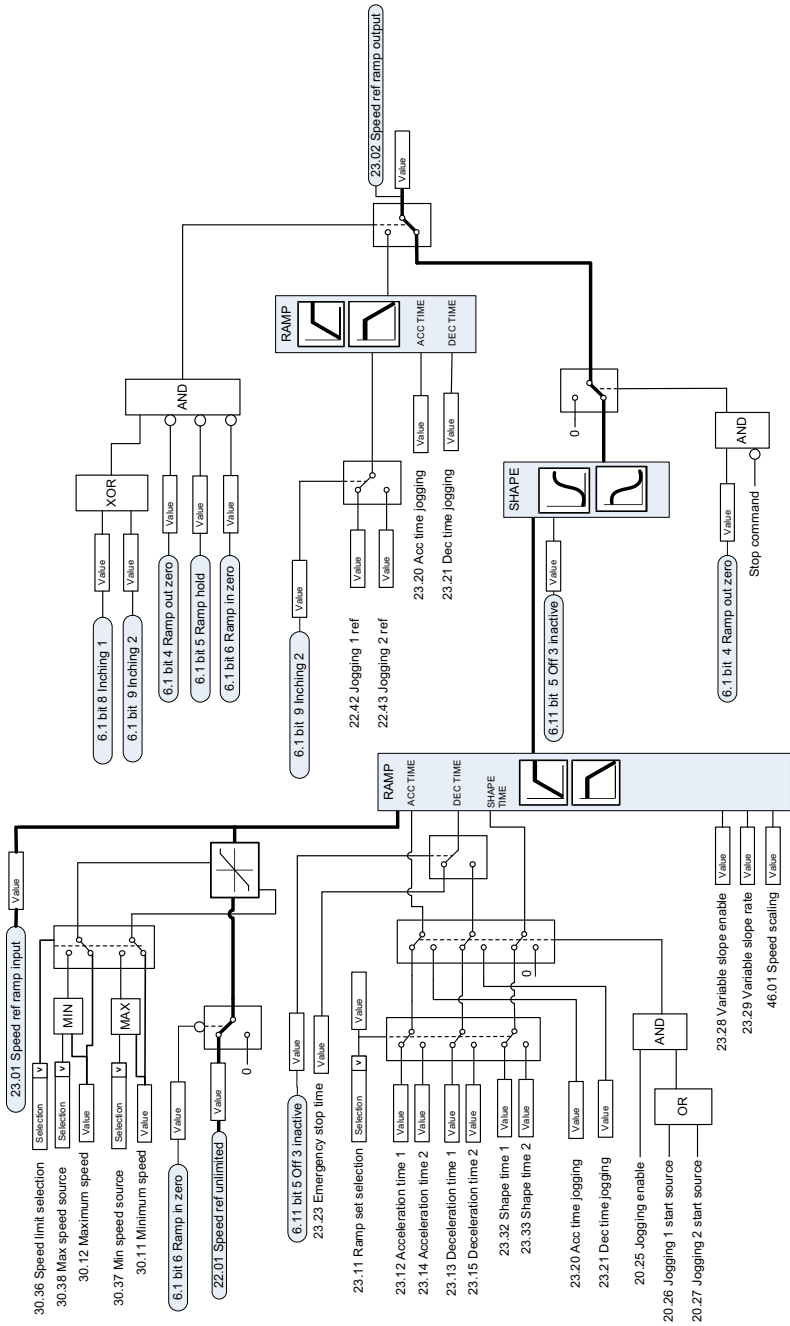

# Speed error calculation

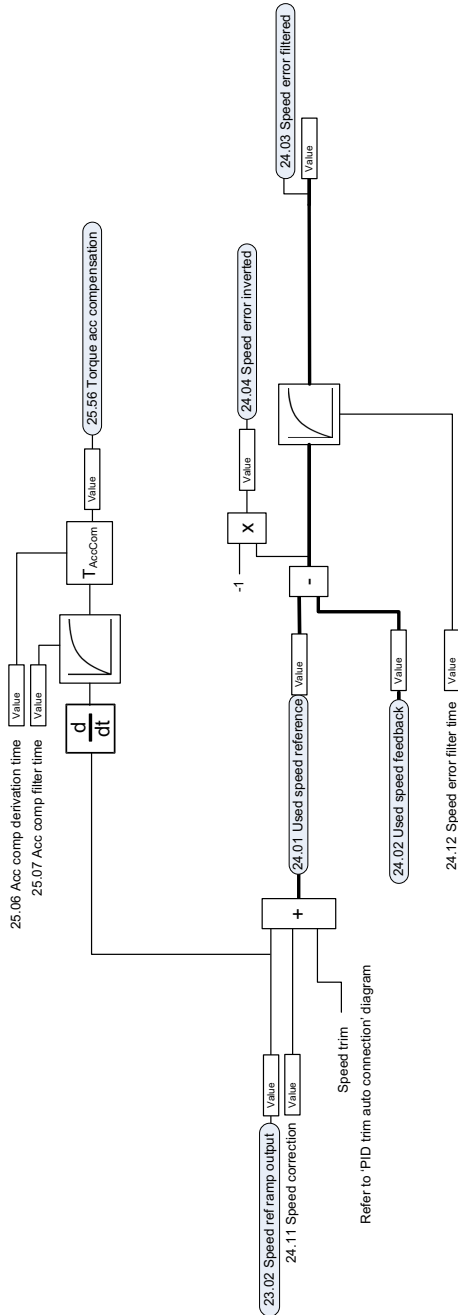

# Speed feedback

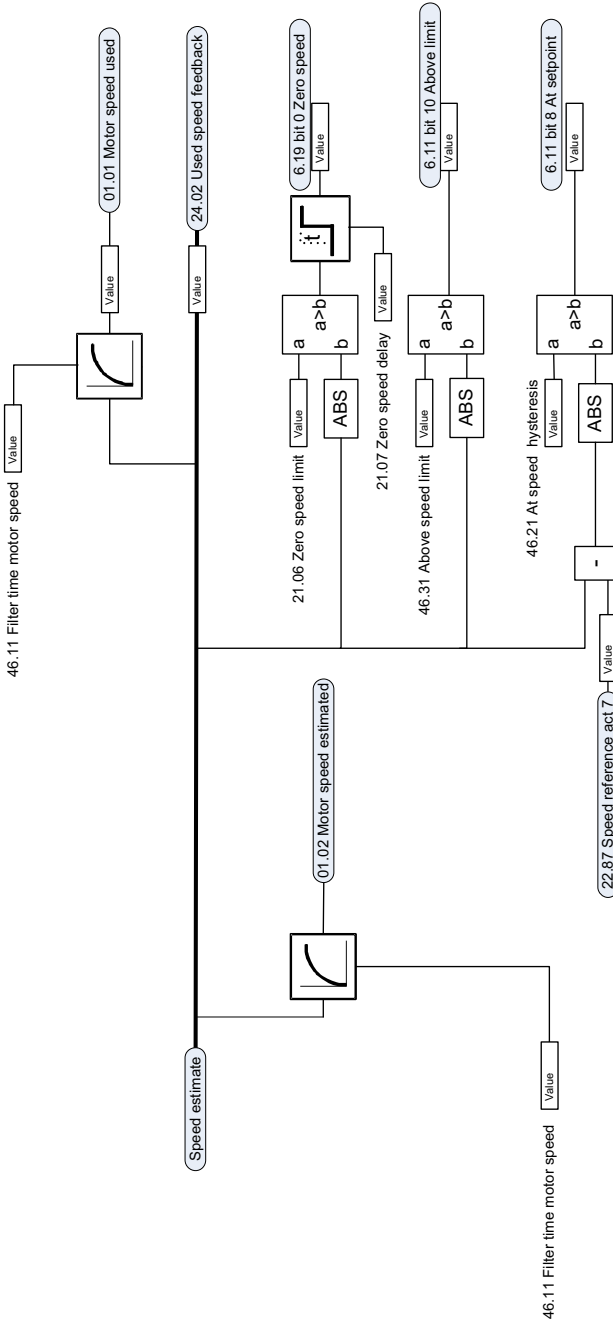

## Speed controller

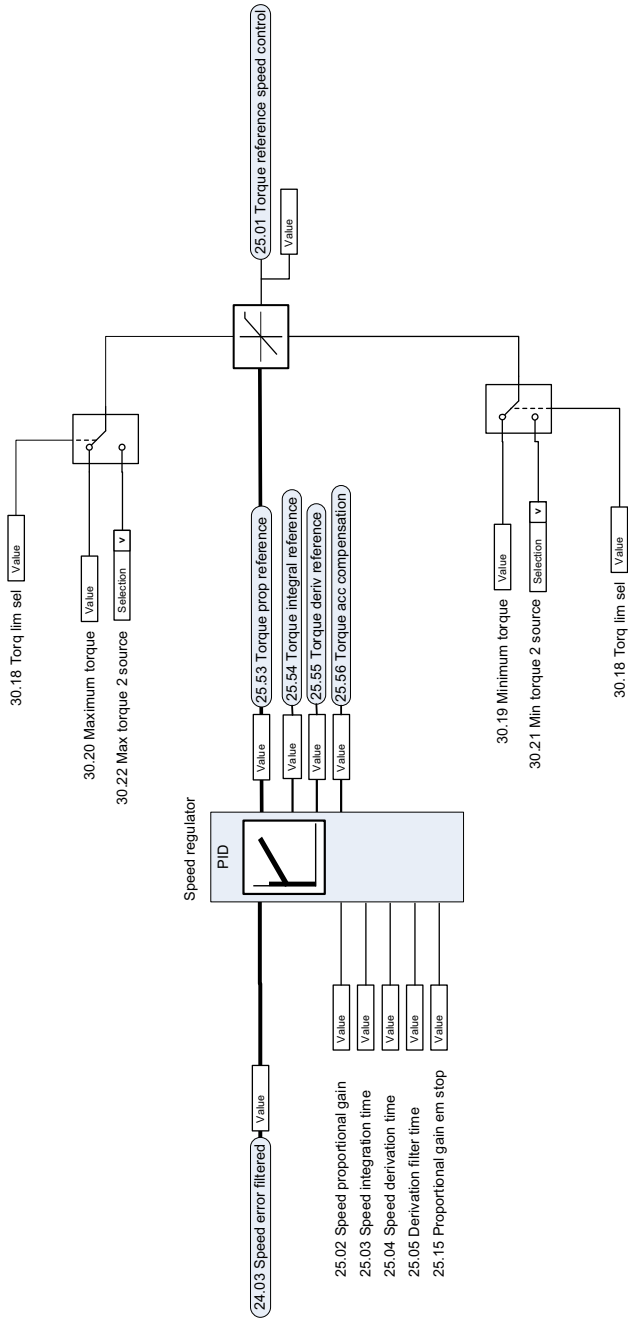

# Torque reference source selection and modification

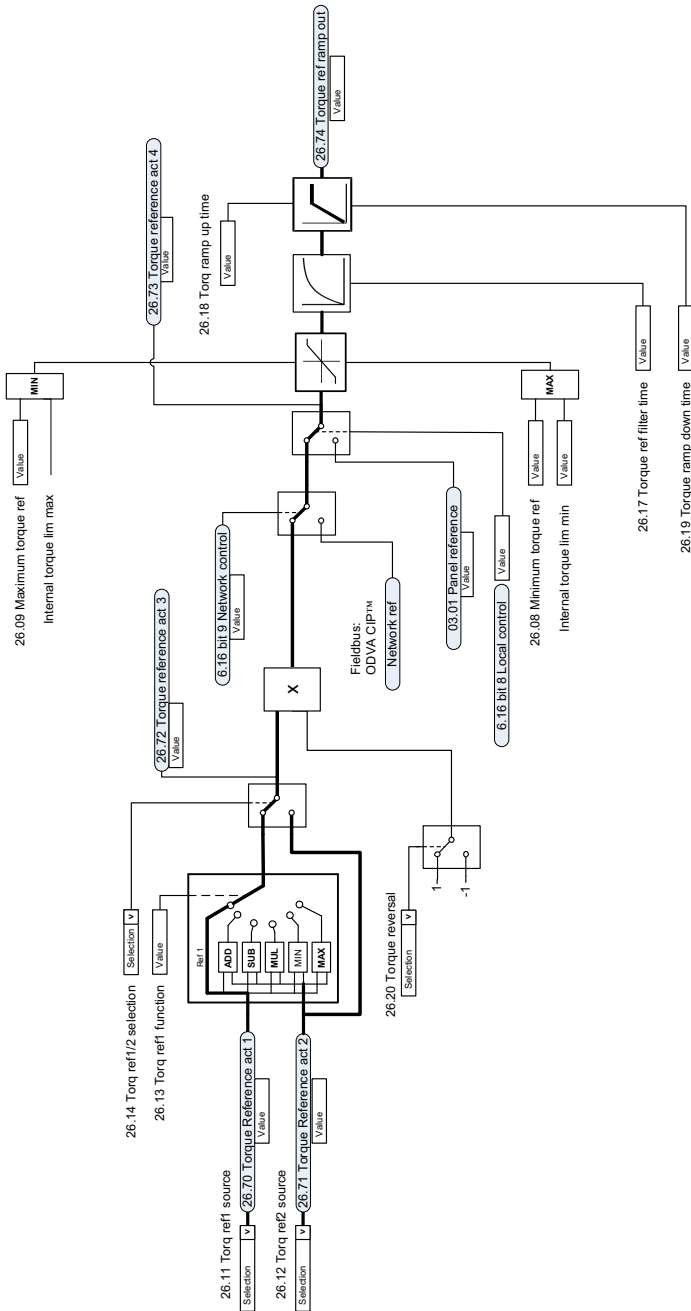



# Reference selection for torque controller

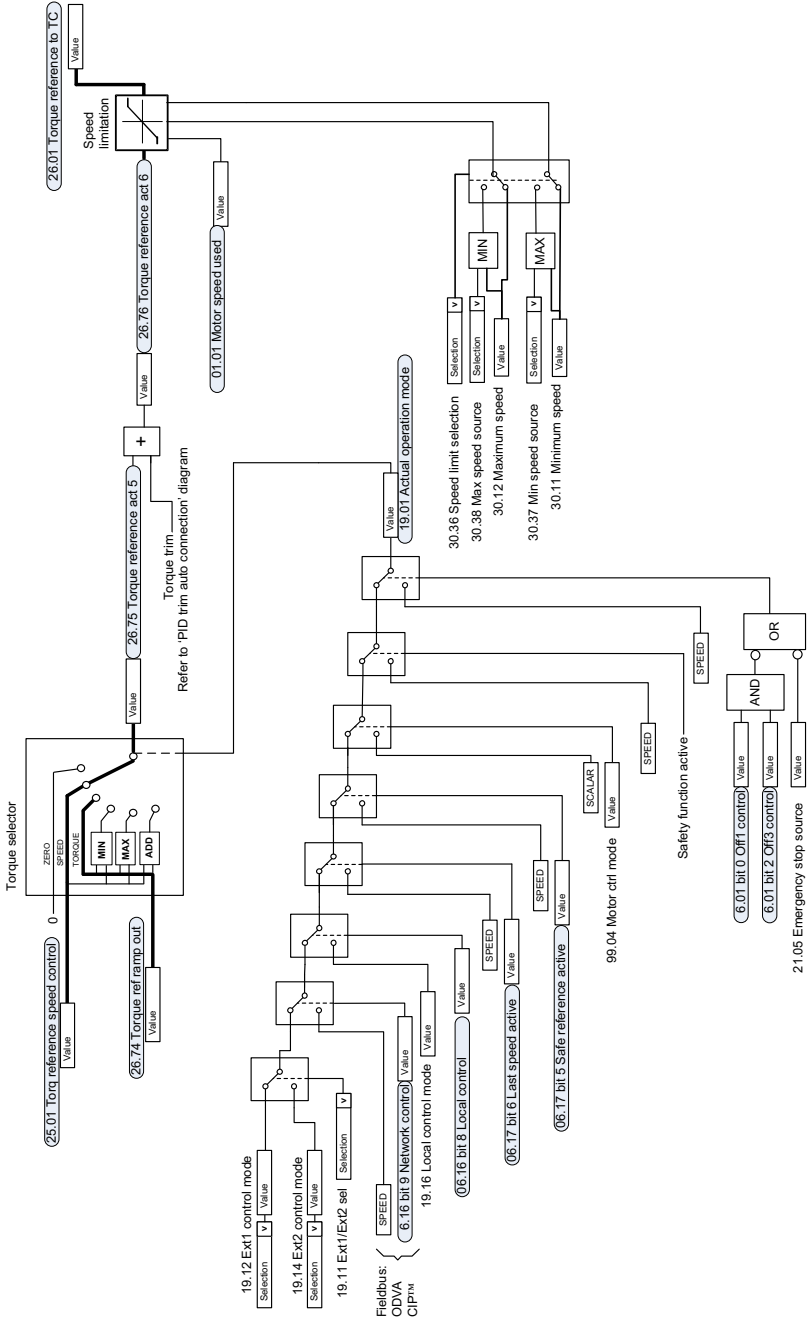

# Torque limitation

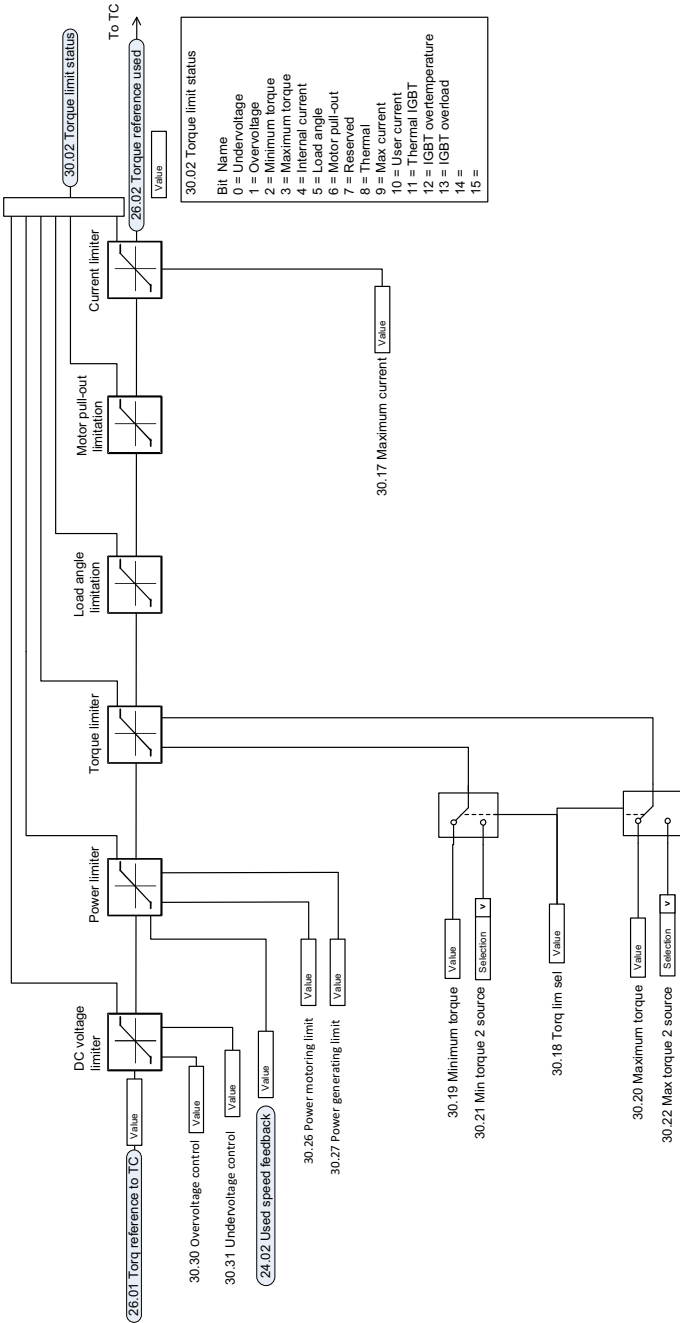

# Process PID setpoint and feedback source selection

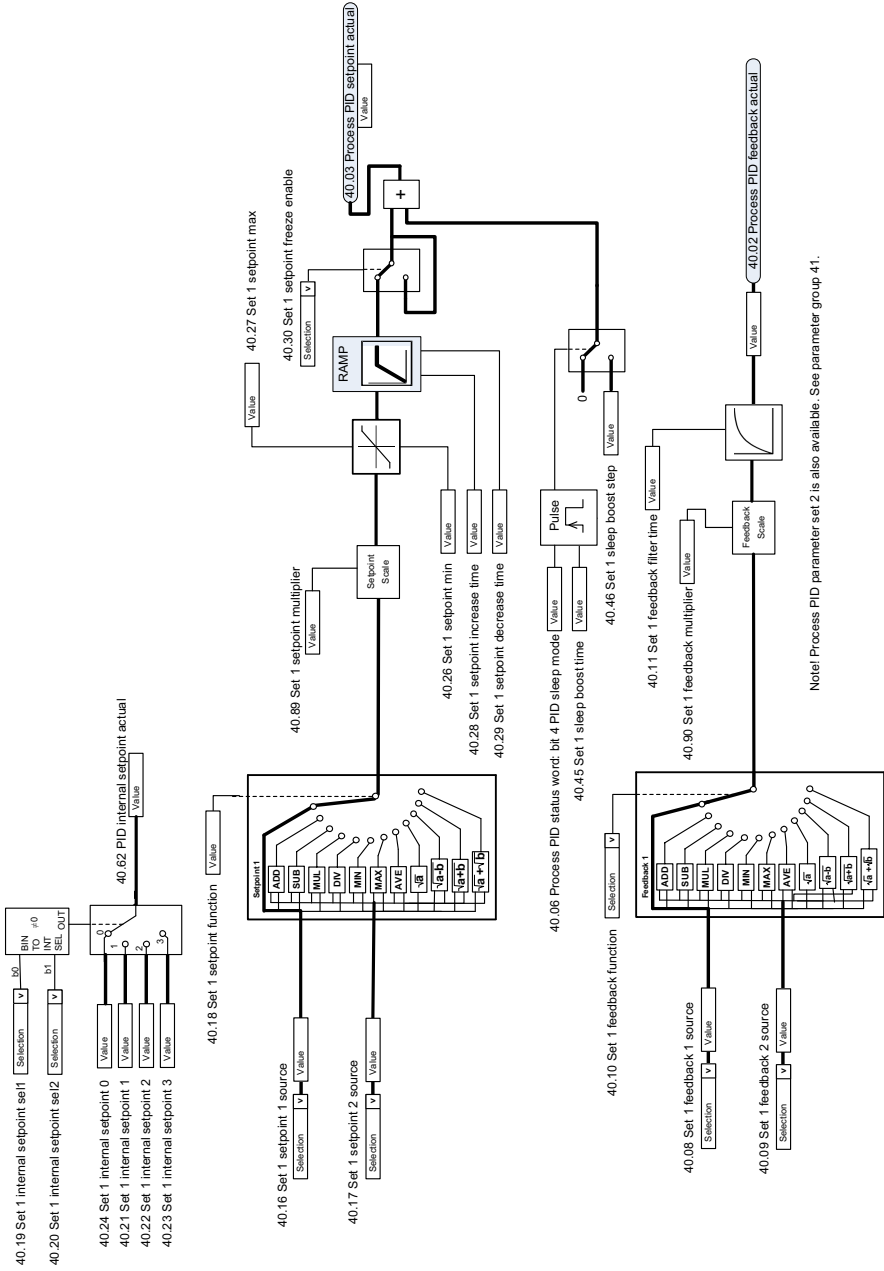

Note! Process PID parameter set 2 is also available. See parameter group 41.

# Process PID controller

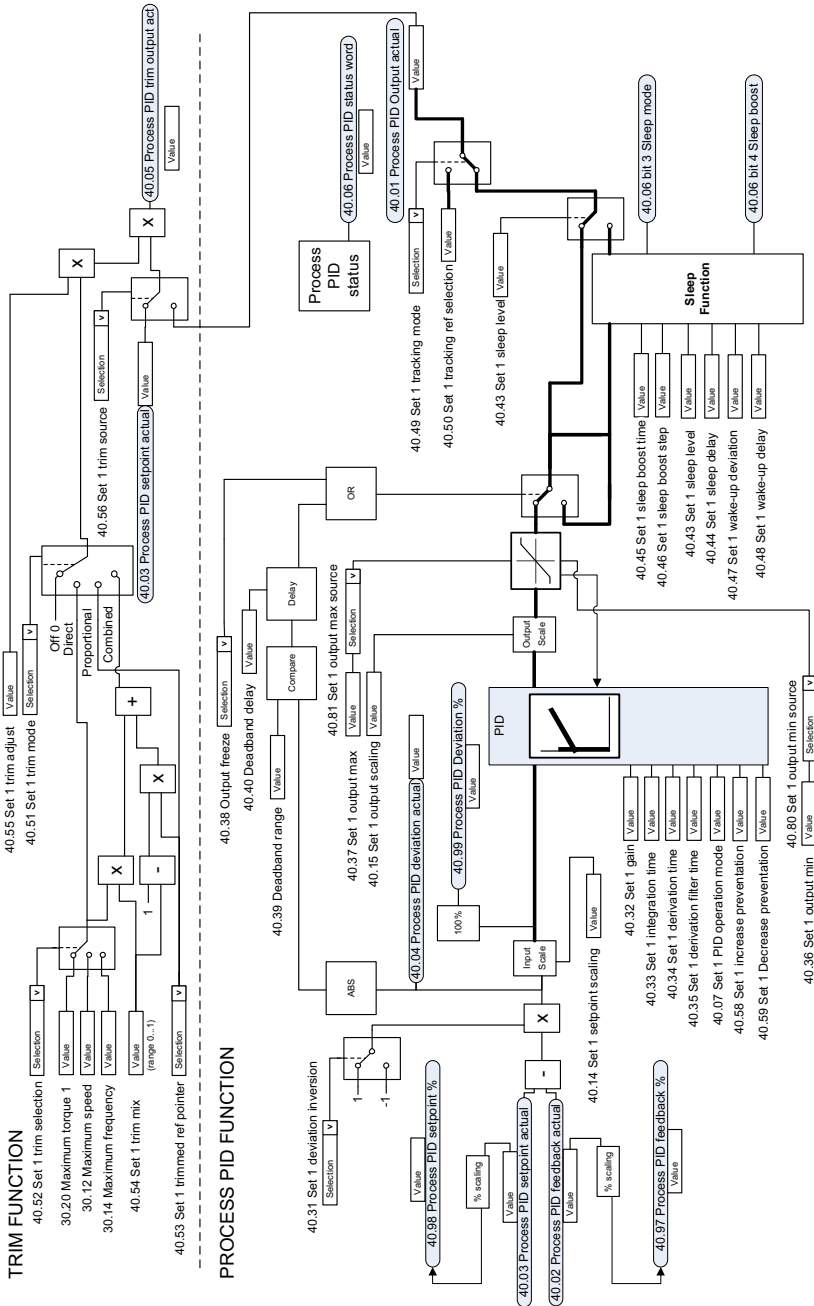

Note! Process PID parameter set 2 is also available. See parameter group 41.

# External PID setpoint and feedback source selection

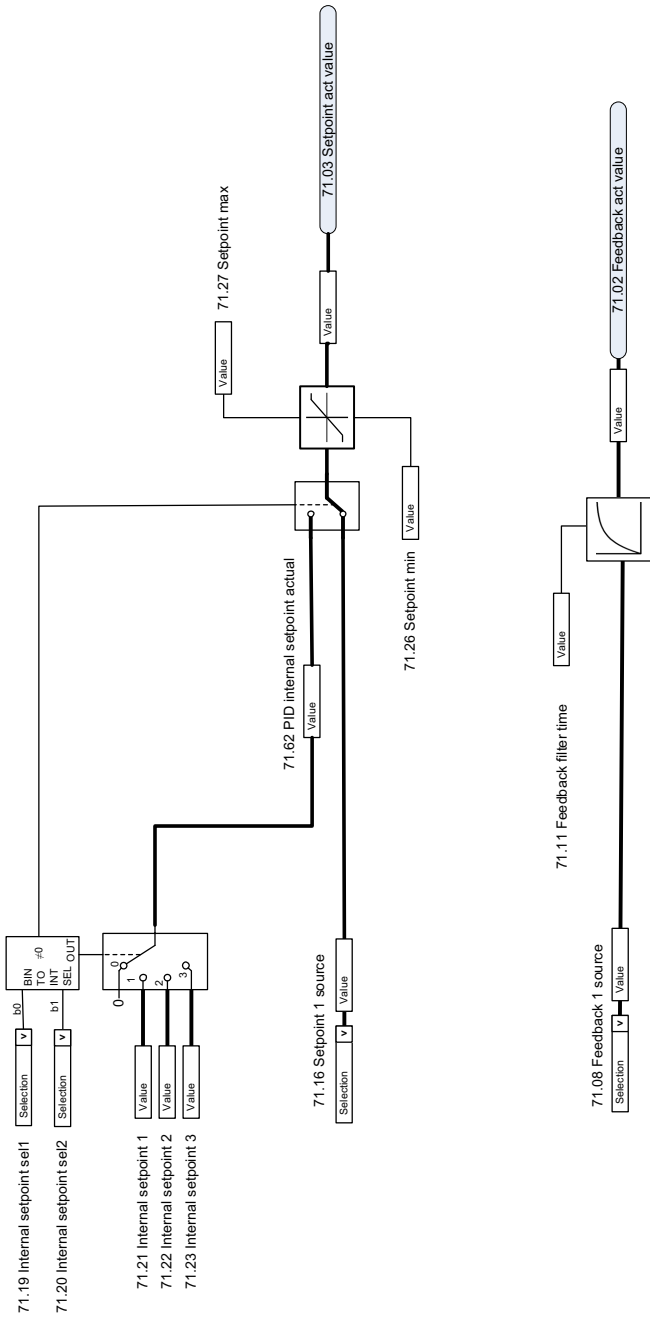

# External PID controller

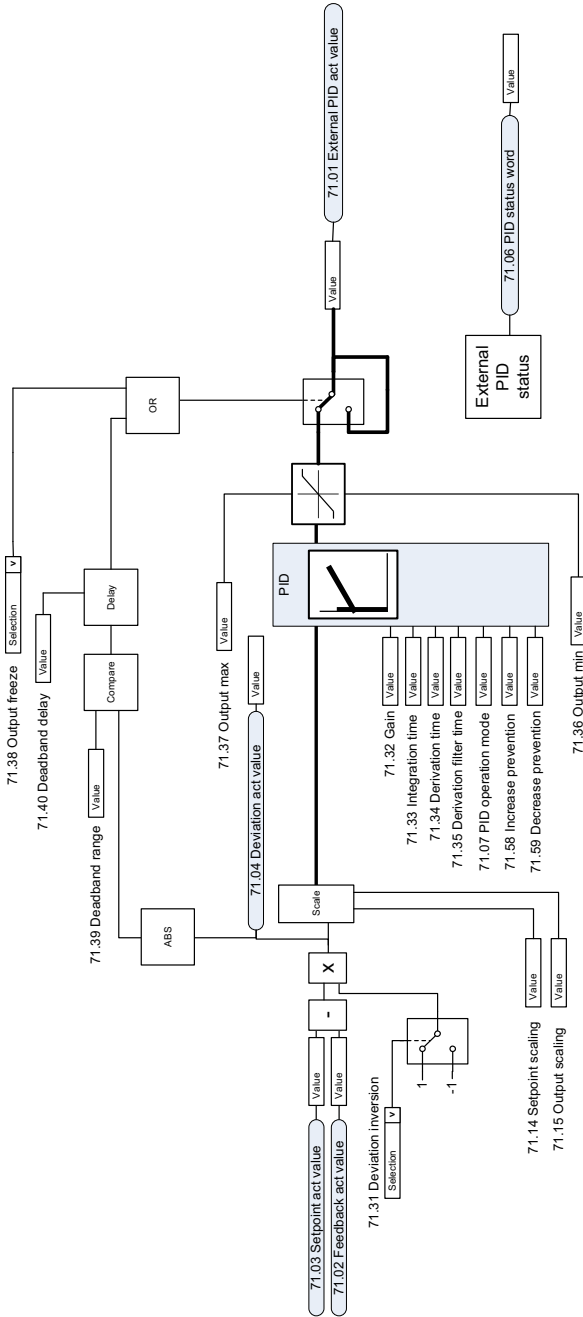

# Direction lock

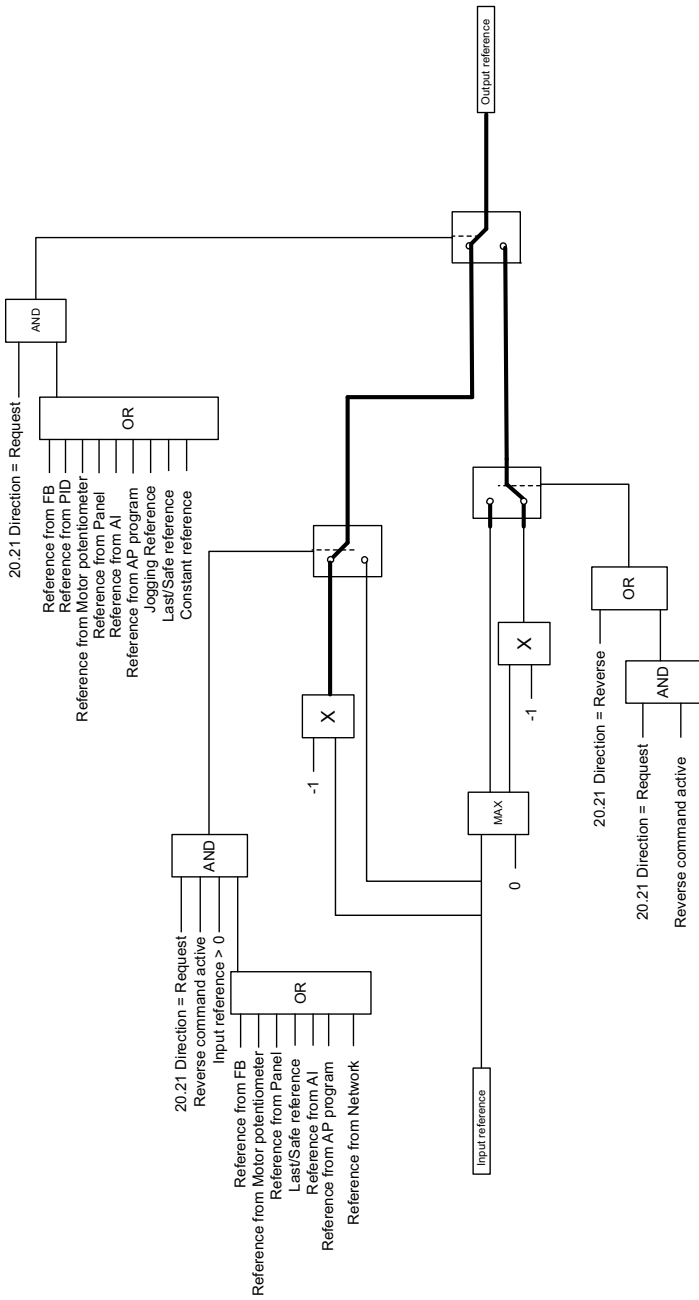

# PID trim auto connection

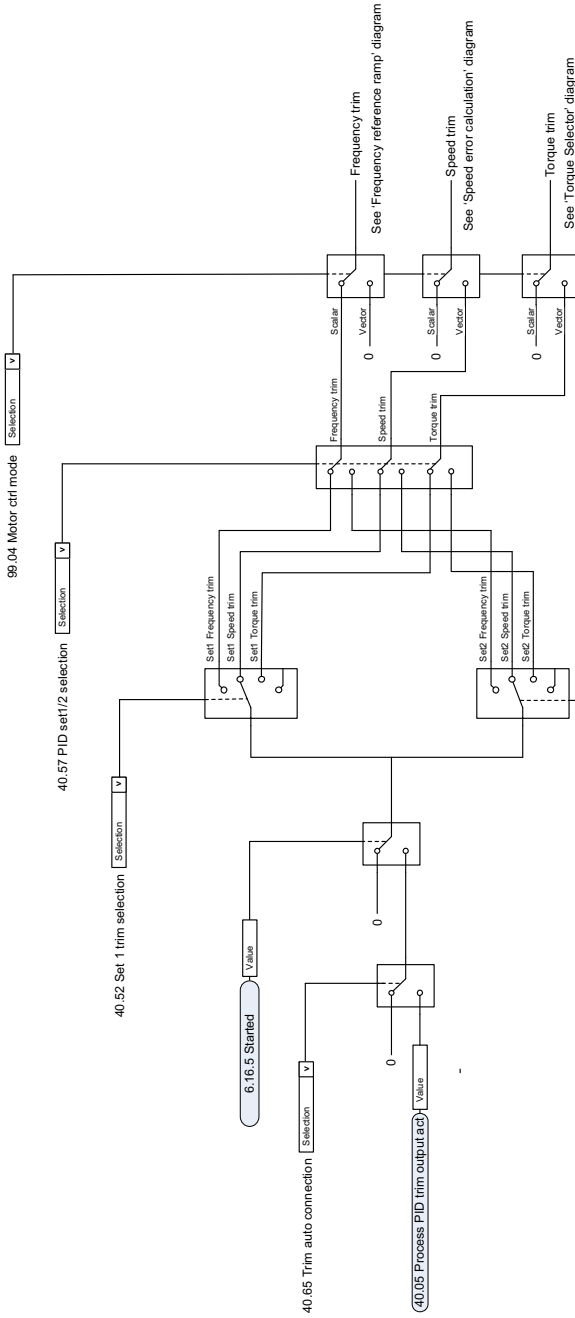



---

# Further information

## **Product and service inquiries**

Address any inquiries about the product to your local ABB representative, quoting the type designation and serial number of the unit in question. A listing of ABB sales, support and service contacts can be found by navigating to [abb.com/searchchannels](http://abb.com/searchchannels).

## **Product training**

For information on ABB product training, navigate to [new.abb.com/service/training](http://new.abb.com/service/training).

## **Providing feedback on ABB Drives manuals**

Your comments on our manuals are welcome. Navigate to [new.abb.com/drives/manuals-feedback-form](http://new.abb.com/drives/manuals-feedback-form).

## **Document library on the Internet**

You can find manuals and other product documents in PDF format on the Internet at [abb.com/drives/documents](http://abb.com/drives/documents).



[abb.com/drives](http://abb.com/drives)



3AXD50000016097F